

KAWAI

CN39 Owner's Manual

Introduction

Playing the Piano

Music Menu

Recorder

Settings

Appendix

EN

Thank you for purchasing this Kawai CN39 digital piano.

This owner's manual contains important information regarding the instrument's usage and operation.

Please read all sections carefully, keeping this manual handy for future reference.

■ About this Owner's Manual

Before attempting to play this instrument, please read the **Introduction** section from page 10 of this owner's manual. This section explains the name and function of each part, how to connect the power cable, and how to turn on the power.

The **Playing the Piano** section (page 19) provides an overview of the instrument's commonly used functions, allowing the CN39 digital piano to be enjoyed almost immediately after being connected, while the **Music Menu** section (page 38) includes information regarding the built-in demonstration songs, Piano Music pieces, Lesson and Finger Exercise features, and Concert Magic function.

The **Recorder** section (page 50) provides instructions on how to record and play back pieces stored both in the instrument's internal memory, and also MP3/WAV audio files saved to a USB memory device. The **Settings** section (page 68) details the various options and settings that can be used to adjust the sound and operation of the instrument.

Finally, the **Appendix** section (page 131) includes lists for all internal sounds, songs, and drum rhythms, assembly instructions for the CN39 model, MIDI reference information, and full specification details.

Important Safety Instructions

SAVE THESE INSTRUCTIONS

INSTRUCTIONS PERTAINING TO A RISK OF FIRE, ELECTRIC SHOCK, OR INJURY TO PERSONS



AVIS : RISQUE DE CHOC ELECTRIQUE - NE PAS OUVRIR.

TO REDUCE THE RISK OF ELECTRIC SHOCK, DO NOT REMOVE COVER (OR BACK).
NO USER-SERVICEABLE PARTS INSIDE. REFER SERVICING TO QUALIFIED SERVICE PERSONNEL.



The lightning flash with arrowhead symbol, within an equilateral triangle, is intended to alert the user to the presence of uninsulated "dangerous voltage" within the product's enclosure that may be of sufficient magnitude to constitute a risk of electric shock to persons.



The exclamation point within an equilateral triangle is intended to alert the user to the presence of important operating and maintenance (servicing) instructions in the literature accompanying the product.

Examples of Picture Symbols



denotes that care should be taken.
The example instructs the user to take care not to allow fingers to be trapped.



denotes a prohibited operation.
The example instructs that disassembly of the product is prohibited.





denotes an operation that should be carried out.
The example instructs the user to remove the power cord plug from the AC outlet.

Read all the instructions before using the product.

- 1) Read these instructions.
- 2) Keep these instructions.
- 3) Heed all warnings.
- 4) Follow all instructions.
- 5) Do not use this apparatus near water.
- 6) Clean only with dry cloth.
- 7) Do not block any ventilation openings. Install in accordance with the manufacturer's instructions.
- 8) Do not install near any heat sources such as radiators, heat registers, stoves, or other apparatus (including amplifiers) that produce heat.
- 9) Do not defeat the safety purpose of the polarized or grounding-type plug. A polarized plug has two blades with one wider than the other. A grounding type plug has two blades and a third grounding prong. The wide blade or the third prongs are provided for your safety. If the provided plug does not fit into your outlet, consult an electrician for replacement of the obsolete outlet.
- 10) Protect the power cord from being walked on or pinched particularly at plugs, convenience receptacles, and the point where they exit from the apparatus.
- 11) Only use attachments/accessories specified by the manufacturer.
- 12) Use only with the cart, stand, tripod, bracket, or table specified by the manufacturer, or sold with the apparatus. When a cart is used, use caution when moving the cart/apparatus combination to avoid injury from tip-over. 
- 13) Unplug this apparatus during lightning storms or when unused for long periods of time.
- 14) Refer all servicing to qualified service personnel. Servicing is required when the apparatus has been damaged in any way, such as power-supply cord or plug is damaged, liquid has been spilled or object have fallen into the apparatus, the apparatus has been exposed to rain or moisture, does not operate normally, or has been dropped.

Règles de sécurité (Supplémentaires pour le Canada)

CONSERVEZ CES INSTRUCTIONS

	CAUTION RISK OF ELECTRIC SHOCK DO NOT OPEN		AVERTISSEMENT POUR REDUIRE LES RISQUES D'INCENDIE OU D'ELECTROCUTION, PROTEGEZ CET APPAREIL DE LA PLUIE OU DE L'HUMIDITE.
---	---	---	---

AVIS : RISQUE DE CHOC ELECTRIQUE - NE PAS OUVRIR.

POUR REDUIRE LES RISQUES D'INCENDIE OU D'ELECTROCUTION, NE DEMONTEZ PAS LE COUVERCLE (OU L'ARRIERE). A L'INTERIEUR, AUCUNE PARTIE N'EST REPARABLE PAR L'UTILISATEUR. POUR LA MAINTENANCE, ADRESSEZ-VOUS A DU PERSONNEL QUALIFIE.





Le symbole de l'éclair avec une pointe de flèche à l'intérieur d'un triangle équilatéral met en garde l'utilisateur contre la présence de tension dangereuse, non isolée, à l'intérieur de l'appareil, dont l'amplitude peut être suffisante pour induire un risque d'électrocution d'une personne.



Le point d'exclamation à l'intérieur d'un triangle équilatéral alerte l'utilisateur de la présence de règles d'utilisation et d'entretien importantes dans la notice qui accompagne l'appareil.

Exemples de symboles graphiques

	Indique que des précautions doivent être prises. L'exemple indique à l'utilisateur qu'il doit faire attention à ne pas se faire coincer les doigts.
	Indique une manipulation interdite. L'exemple indique que le démontage de l'appareil est interdit.
	Indique qu'une manipulation doit être effectuée. L'exemple indique à l'utilisateur qu'il doit débrancher le câble d'alimentation de la prise secteur.



AVERTISSEMENT

Indique un risque potentiel qui peut entraîner la mort, ou de graves lésions, si l'appareil n'est pas manipulé correctement.

Faite attention de ne pas introduire un produit étranger à l'intérieur de l'appareil.

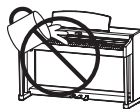

L'introduction d'eau, d'aiguilles ou d'épingles à cheveux, peut provoquer une panne ou un court-circuit. Ce produit doit être mis à l'abri des écoulements ou projections d'eau. Ne jamais placer sur le produit des objets contenant des liquides, tels que des vases ou autres récipients.

Ce produit n'est pas totalement déconnecté du circuit électrique lorsqu'il est mis hors tension par le bouton d'arrêt. Si l'appareil ne doit pas être utilisé pendant une longue période, débranchez le câble d'alimentation de la prise secteur.



- Si vous ne le faisiez pas la foudre pourrait provoquer un incendie.
- Si vous ne le faisiez pas, la surchauffe de l'appareil pourrait provoquer un incendie.

Il est recommandé de placer l'instrument à proximité de la prise de courant et de positionner le câble d'alimentation secteur de sorte qu'il puisse être débranché rapidement en cas d'urgence, le courant électrique étant toujours présent tant que la prise est branchée même si le bouton de mise en marche est en position Arrêt.

[Seuls les produits avec 3P fiche]

INSTRUCTIONS DE MISE À LA TERRE

Ce produit doit être mis à la terre. En cas de défaillance matérielle ou de panne, la mise à la terre fournit un chemin de moindre résistance au courant électrique afin de réduire le risque d'électrocution. Ce produit est équipé d'un câble avec un conducteur de protection et une fiche de mise à la terre. La fiche doit être branchée dans une prise appropriée correctement installée et mise à la terre conformément à tous les codes et règlements locaux.

DANGER - La connexion incorrecte du conducteur de protection peut présenter un risque d'électrocution.

Consultez un électricien ou un réparateur qualifié si vous avez des doutes en ce qui concerne la mise à la terre du produit. Ne modifiez pas la fiche fournie avec le produit – si elle n'est pas adaptée à la prise, faites installer une prise correcte par un électricien qualifié.



PRECAUTION

Indique un risque potentiel qui peut entraîner la détérioration, ou des dommages, pour l'appareil ou ses propriétés, si celui-ci n'est pas manipulé correctement.

Description de la l'emplacement de la référence (Le cas échéant):

Anglais phrase: The nameplate label is located on the underside of the instruments, as indicated below.

Français phrase: La référence commerciale est inscrite sur une étiquette en dessous de votre instrument, conformément à l'indication ci-dessous.

Votre piano doit être placé à un endroit tel que sa position n'altère pas sa propre ventilation. Gardez une distance minimum de 5 cm autour de l'instrument pour une aération suffisante.

WARNING - When using electric products, basic precautions should always be followed, including the following.



WARNING

Indicates a potential hazard that could result in death or serious injury if the product is handled incorrectly.

The product should be connected to an AC outlet of the specified voltage.

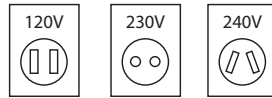

- If you are going to use an AC power cord, make sure that its has the correct plug shape and conforms to the specified power voltage.
- Failure to do so may result in fire.

Do not insert or disconnect the power cord plug with wet hands.



Doing so may cause electric shock.

Take care not to allow any foreign matter to enter the product.

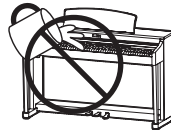

Entry of water, needles or hair pins may result in breakdown or short-circuit. The product shall not be exposed to dripping or splashing. No objects filled with liquids, such as vases, shall be placed on the product.

The chair must be used properly (it must be used only when playing the product).

- Do not play with it or stand on it.
- Only one person is allowed to sit on it.
- Do not sit on it when opening the lid.
- Re-tighten the bolts occasionally.

Doing so may cause the chair to fall over or your fingers to be trapped, resulting in injury.

When using the headphones, do not listen for long periods of time at high volume levels.



Doing so may result in hearing problems.

Do not lean against the keyboard.

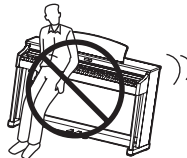

Doing so may cause the product to fall over, resulting in injury.

Do not disassemble, repair or modify the product.

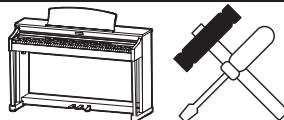

Doing so may result in product breakdown, electric shock or short-circuit.

When disconnecting the AC power cord's plug, always hold the plug and pull it to remove it.



Pulling the AC power cord itself may damage the cord, causing a fire, electric shock or short-circuit.

The product is not completely disconnected from the power supply even when the power switch is turned off. If the product will not be used for a long time, unplug the AC power cord from the AC outlet.



- Failure to do so may cause fire in case of lightning.
- Failure to do so may over-heat the product, resulting in fire.

This product may be equipped with a polarized line plug (one blade wider than the other). This is a safety feature. If you are unable to insert the plug into the outlet, contact an electrician to replace your obsolete outlet. Do not defeat the safety purpose of the plug.

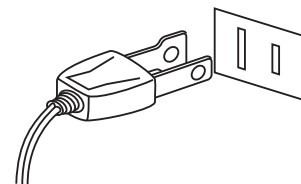

This product shall be near the AC outlet and the power cord plug in a position so that it can readily be disconnected in an emergency because electricity is always charging while the plug is in the AC outlet even in a power switch off condition.



CAUTION

Indicates a potential hazard that could result in injury or damage to the product or other property if the product is handled incorrectly.

Do not use the product in the following areas.

- Areas, such as those near windows, where the product is exposed to direct sunlight
- Extremely hot areas, such as near a heater
- Extremely cold areas, such as outside
- Extremely humid areas
- Areas where a large amount of sand or dust is present
- Areas where the product is exposed to excessive vibrations

Using the product in such areas may result in product breakdown. Use the product only in moderate climates (not in tropical climates).

When you close the keyboard cover, close it gently.



Closing it roughly may trap your fingers, resulting in injury.

Before connecting cords, make sure that the power to this product and other devices is turned OFF.

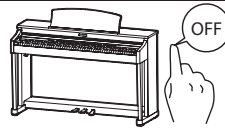

Failure to do so may cause breakdown of this product and other devices.

Do not drag the product on the floor. Take care not to drop the product.

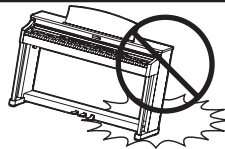

Please lift up the product when moving it. Please note that the product is heavy and must be carried by more than two persons. Dropping the product may result in breakdown.

Do not place the product near electrical appliances such as TVs and radios.

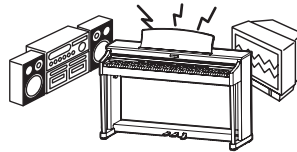

- Doing so may cause the product to generate noise.
- If the product generates noise, move the product sufficiently away from the electrical appliance or connect it to another AC outlet.

When connecting the AC power cord and other cords, take care not to get them tangled.



Failure to do so may damage them, resulting in fire, electric shock or short-circuit.

Do not wipe the product with benzene or thinner.



- Doing so may result in discoloration or deformation of the product.
- When cleaning the product, put a soft cloth in lukewarm water, squeeze it well, then wipe the product.

Do not stand on the product or exert excessive force.



Doing so may cause the product to become deformed or fall over, resulting in breakdown or injury.

Do not place naked flame, such as lighted candles on the product.

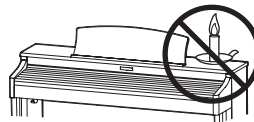

Doing so may cause the illumination to fall over, resulting in fire.

Ensure that the ventilation is not impeded by covering the ventilation openings with items, such as newspaper, table-cloths, curtains, etc.

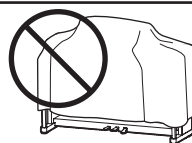

Failure to do so may over-heat the product, resulting in fire.

The product should be located so that its location or position does not interfere with its proper ventilation. Ensure a minimum distance of 5cm around the product for sufficient ventilation.

The product should be serviced by qualified service personnel when:

- The power supply cord or the plug has been damaged.
- Objects have fallen, or liquid has been spilled into the product.
- The product has been exposed to rain.
- The product does not appear to operate normally or exhibits a marked change in performance.
- The product has been dropped, or the enclosure damaged.

Notes on Repair

Should an abnormality occur in the product, immediately turn the power OFF, disconnect the power cord plug, and then contact the shop from which the product was purchased.

CAUTION:

To prevent electric shock, match wide blade of plug to wide slot, fully insert.

ATTENTION:

Pour éviter les chocs électriques, introduire la lame la plus large de la fiche dans la borne correspondante de la prise et pousser jusqu'au fond.



An information on Disposal for users

If your product is marked with this recycling symbol it means that, at the end of its life, you must dispose of it separately by taking it to an appropriate collection point. You should not mix it with general household waste. Disposing of this product correctly will prevent potential negative effects on the environment and human health which could otherwise arise due to inappropriate waste handling. For further details, please contact your local authority. (European Union only)

Instruction for AC power cord (U.K.)

IMPORTANT

THE WIRES IN THIS MAINS LEAD ARE COLOURED IN ACCORDANCE WITH THE FOLLOWING CODE.

BLUE : NEUTRAL
BROWN : LIVE

As the colours of the wires in the mains lead of this apparatus may not correspond with the coloured markings identifying the terminals in your plug, proceed as follows:

The wire which is coloured BLUE must be connected to the terminal which is marked with the letter N or coloured BLACK. The wire which is coloured BROWN must be connected to the terminal which is marked with the letter L or coloured RED. Do not plug either terminal of the power cord to the the ground od AC outlet on the wall.

FCC Information (U.S.A)

CAUTION: Changes or modifications not expressly approved by the party responsible for compliance could void the user's authority to operate the equipment.

NOTE: This equipment has been tested and found to comply with the limits for a Class B digital device, pursuant to Part 15 of the FCC Rules. These limits are designed to provide reasonable protection against harmful interference in a residential installation. This equipment generates, uses and can radiate radio frequency energy and, if not installed and used in accordance with the instructions, may cause harmful interference to radio communications. However, there is no guarantee that interference will not occur in a particular installation. If this equipment does cause harmful interference to radio or television reception, which can be determined by turning the equipment off and on, the user is encouraged to try to correct the interference by one or more of the following measures:

- Reorient or relocate the receiving antenna.
- Increase the separation between the equipment and receiver.
- Connect the equipment into an outlet on a circuit different from that to which the receiver is connected.
- Consult the dealer or an experienced radio/TV technician for help.

Declaration of Conformity

Products :	Electronic Piano
Model Number :	CN39
Responsible Party Name :	Kawai America Corporation
Address :	2055 East University Drive Rancho Dominguez, CA 90220
Telephone	310-631-1771

This device complies with Part 15 of the FCC Rules.
Operation is subject to the following two conditions:
(1) this device may not cause harmful interference, and
(2) this device must accept any interference received, including interference that may cause undesired operation.

The nameplate label is located on the underside of the instrument, as indicated below.

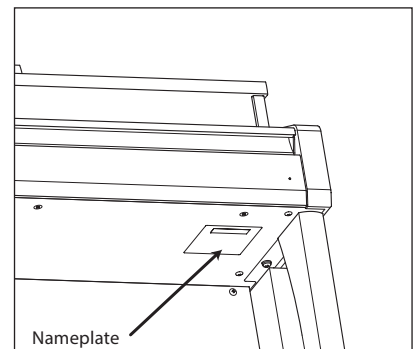

This applies only to products distributed by Kawai America Corporation.

About Bluetooth

- The Bluetooth® word mark and logos are registered trademarks owned by the Bluetooth SIG, Inc. and any use of such marks by Kawai Musical Instruments Mfg. Co., Ltd. is under license. Other trademarks and trade names are those of their respective owners.
- Frequency Band of Radio: 2400~2483.5 MHz
Maximum Transmit Power: 2.5 mW (Bluetooth Low Energy), 4.5mW (A2DP)
- Availability of Bluetooth function dependent on market location.



Table of Contents

Important Safety Instructions	3
Table of Contents	8

Introduction

Welcome to the Kawai CN39 digital piano	10
1. Feature Highlights	10
2. Owner's Manual Conventions	11
Part Names and Functions	12
Setting Up the Piano	14
1. Power	14
2. Key cover and music rest	15
3. Volume and headphones	16
4. Pedals	17

Playing the Piano

Selecting Sounds	19
Dual Mode	20
Split Mode	22
Four Hands Mode	24
Reverb	26
Effects	28
Virtual Technician	30
1. Smart Mode	30
2. Advanced Mode	31
Metronome / Drum Rhythms	32
Registration Memories	34
1. Selecting a Registration memory	34
2. Storing a Registration memory	35
3. Registration Edit menu	36
Panel Lock	37

Music Menu

Demo Songs	38
Piano Music	39
Lesson Function	40
1. Selecting a lesson book/song	40
2. Listening to the selected lesson song	41
3. Lesson Function settings	42
4. Repeating sections of a lesson song	43
5. Recording a lesson song practice	44
6. Finger Exercises	45

Concert Magic	46
1. Performing a Concert Magic song	46
2. Concert Magic demo mode	47
3. Concert Magic settings	48
Steady Beat mode	48
4. Concert Magic song arrangement types	49

Recorder

Internal Recorder	50
1. Recording a song	50
2. Playing a song	52
3. Internal Recorder Edit menu	53
4. Erasing a part/song	54
5. Converting a song to an audio file	55
USB Recorder	56
1. Recording an MP3/WAV audio file	56
2. Playing an MP3/WAV audio file	58
3. Recording a MIDI song file	60
4. Playing a MIDI song file	62
5. USB Recorder Edit menu	64
6. Converting a MIDI song file to an MP3/WAV audio file	65
7. Overdubbing an MP3/WAV audio file	66
8. Recording to an existing MIDI song file	67

Settings

Function menus	68
Basic Settings	69
1. Key Transpose	70
2. Song Transpose	71
3. Tone Control	72
User Tone Control	73
4. Speaker Volume	74
5. Tuning	75
6. Damper Hold	76
7. Split	77
8. Four Hands	78
9. Startup Setting	79
10. Factory Reset	80
11. Auto Display Off	81
12. Auto Power Off	82

Settings (cont.)

Virtual Technician Settings	83
1. Touch Curve	85
User Touch Curve	86
2. Voicing	87
User Voicing	88
3. Damper Resonance	89
4. Damper Noise	90
5. String Resonance	91
6. Undamped String Resonance	92
7. Cabinet Resonance	93
8. Key-off Effect	94
9. Fall-back Noise	95
10. Hammer Delay	96
11. Topboard Simulation	97
12. Decay Time	98
13. Minimum Touch	99
14. Stretch Tuning	100
User Tuning	101
15. Temperament	102
User Temperament	103
16. Temperament Key	104
17. Key Volume	105
User Key Volume	106
18. Half-Pedal Adjust	107
19. Soft Pedal Depth	108
Phones Settings	109
1. SHS Mode	110
2. Phones Type	111
3. Phones Volume	112
USB MIDI (USB to Host connector)	113
USB Menu	114
1. Load Song	115
2. Load Registration All	116
3. Load Registration Single	117
4. Load Startup Setting	118
5. Save Internal Song	119
6. Save SMF Song	120
7. Save Registration All	121
8. Save Registration Single	122
9. Save Startup Setting	123
10. Rename File	124
11. Delete File	125
12. Format USB	126

Bluetooth Settings	127
1. Bluetooth Audio	128
2. Bluetooth Audio Volume	129
3. Bluetooth MIDI	130

Appendix

Assembly Instructions	131
Connecting to Other Devices	135
Jack Panel	136
Headphone Panel	136
Troubleshooting	137
Demo Song List	139
Settings List	140
Sound List	142
Drum Sound Mapping List	146
Drum Rhythm List	148
Specifications	149

* For information regarding MIDI functions and settings, please download the supplementary PDF manual from the Kawai Japan website: <http://www.kawai-global.com/support/manual/>

Welcome to the Kawai CN39 digital piano

1 Feature Highlights

'Responsive Hammer III' weighted-key action, with Ivory Touch key surfaces and Let-off simulation

The CN39 digital piano's *Responsive Hammer III* (RHIII) action recreates the distinctive touch of an acoustic grand piano, with its realistic movement and accurate 3-sensor technology providing a smooth, natural, and highly responsive piano playing experience. The weight of the keyboard is appropriately graded to mirror the heavier bass hammers and lighter treble hammers of an acoustic piano, while structural reinforcements within the action assembly ensure greater stability during fortissimo and staccato passages.

The CN39 digital piano also features Kawai's *Ivory Touch* key surfaces that gently absorb finger moisture to assist the player's performance, while, *let-off simulation* recreates the subtle 'notch' sensation felt when softly playing the keys of a grand piano, satisfying the expectations of the most discerning pianists.

Shigeru Kawai SK-EX and Kawai EX instruments reproduced with Harmonic Imaging sound technology

The CN39 digital piano captures the magnificent tone of Kawai's flagship Shigeru Kawai *SK-EX* full concert grand piano. Widely regarded as the 'premier pianos of Japan', Shigeru Kawai instruments grace the stages of concert halls and musical institutions throughout the world, and are prized for their exceptional tonal clarity. In addition, the CN39 also features the distinctive sound of Kawai's highly acclaimed *EX* concert grand piano, which has frequently been selected by professional pianists in such prestigious events as the Chopin, Tchaikovsky, and Rubinstein international piano competitions, among others.

Both instruments have been carefully recorded, meticulously analysed, and faithfully reproduced with full 88-key sampling using *Harmonic Imaging™* sound technology. This unique process accurately recreates the broad dynamic range of the original grand pianos, affording pianists an extraordinary level of expressiveness ranging from the softest pianissimo to the strongest, boldest fortissimo.

Strong selection of additional instrument sounds

Supplementing the realistic acoustic piano voices, the CN39 digital piano also features an excellent selection of additional instrument sounds, ranging from electric pianos and drawbar and church organs, to strings, human choirs, and even atmospheric synth-style pads, inviting musicians to add greater variety to their performances.

Furthermore, the *Dual* playing mode also allows two different sounds, such as grand piano and strings, to be layered together, while the *Split* and *Four Hands* modes divide the keyboard into two independent sections. The volume balances for each playing mode can also be adjusted quickly and easily using the real-time panel controls.

Virtual Technician adjustments to personalise the instrument's character

The CN39 digital piano's *Virtual Technician* feature allows various characteristics of the selected acoustic piano, electric piano, or harpsichord sound to be shaped at the touch of a button, with settings to adjust voicing and regulation, string, damper, and cabinet resonances, and subtle hammer, damper, and key release noises. It is even possible to adjust the precise tuning and volume of individual notes, before storing one's personalised instrument configuration to memory.

USB to Device functionality, with MP3/WAV file recording and playback

The CN39 digital piano is equipped with USB connectors that not only allow this instrument to be connected to a computer for MIDI use, but also to load and save data to USB memory devices directly. This '*USB to Device*' feature allows instrument settings or recorded songs stored in internal memory to be saved to USB for posterity, or standard MIDI files (SMF) downloaded from the internet to be conveniently played back without additional hardware.

USB memory devices can also be used to play back MP3 or WAV audio files, allowing musicians to learn the chords or melody for a new piece, or to simply play along with their favourite songs. It is even possible to record performances as MP3 or WAV files for emailing to friends and family, listening to on the move, or for further editing using an audio workstation.

Integrated Bluetooth® MIDI connectivity

In addition to standard MIDI jacks for connecting to other instruments, the CN39 digital piano also boasts integrated Bluetooth MIDI and Audio technology that allows the instrument to communicate with supported smart devices wirelessly. Once connected to a phone, tablet, or laptop, CN39 digital piano owners can enjoy a wide variety of exciting music-related apps that enhance their learning and playing experience, or stream audio from songs and videos through the instrument's speakers without additional cables.

* Availability of Bluetooth function dependent on market location.

Wide range of connectivity options

The CN39 digital piano features a variety of connectivity options, with Line-level output jacks that allow the instrument to be enjoyed in larger settings such as churches and schools. Standard MIDI and 'USB to Host' connectors ensure flexibility when using computers and other electronic instruments, while the Line-in jacks provide a convenient method of mixing in audio from a laptop, tablet, or other audio device.

2 Owner's Manual Conventions

This owner's manual utilises a number of illustrative conventions in order to explain the CN39 digital piano's various functions. The examples below provide an overview of the button LED indicator states and press types, and the appearance of different kinds of text.

■ Button LED indicator states



LED indicator off:
Sound/Function is not selected.



LED indicator on:
Sound/Function is selected.

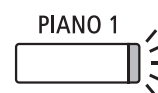

LED indicator flashing:
Sound/Function is selected in a temporary state.

■ Button press types

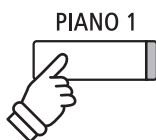

Normal press:
Select a sound or function.

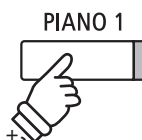

Press twice:
Select a sound or function.



Press multiple times:
Cycle through sounds or settings.

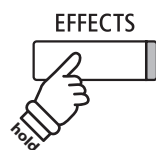

Press and hold:
Select a function's settings, or store registration memories etc.

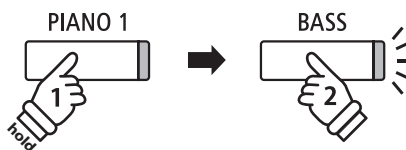

Press and hold, then press X:
Combine two sounds.

■ Text appearance

Normal instruction and explanation text is written in regular type at 9 pt. size.

* Notes about functions are marked with an asterisk and written in 8 pt. size.

Reminders about previous operations are written in italic type at 9 pt. size.

— Captions explaining the LCD display or button functions, are written in bold type at 8.5 pt. size.

Example operations are written in italic type at 8 pt. size, and enclosed within a grey box.

Part Names and Functions

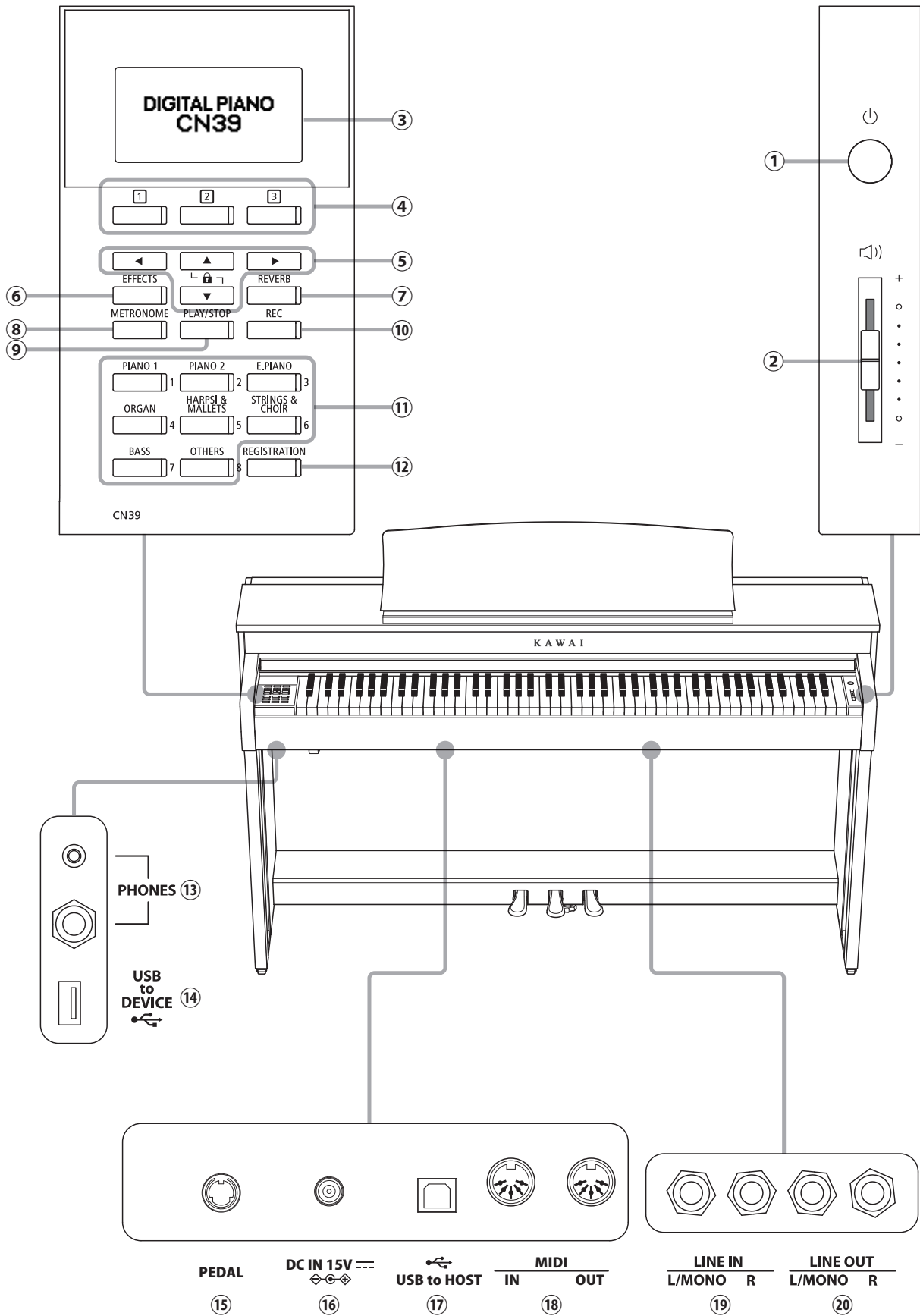

① POWER button

This switch is used to turn the instrument on/off. Be sure to turn off the instrument after playing.

* The CN39 digital piano features a power saving mode that can turn off the instrument automatically after a specified period of inactivity. For more information, please refer to the 'Auto Power Off' setting on page 82.

② MASTER VOLUME slider

This slider controls the master volume level of the instrument's built-in speakers or headphones, if connected.

* The MASTER VOLUME slider will also affect the volume level of the LINE OUT connectors.

③ LCD display

The LCD display provides useful information such as the currently selected sound name, settings values, and the status of other functions when active. An example of the main play screen is shown below.

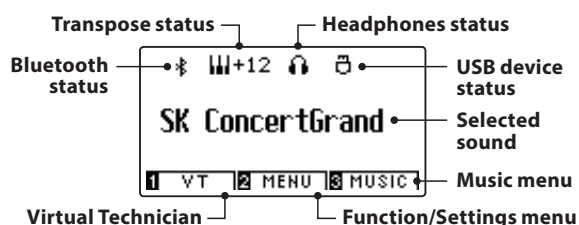

* A protective plastic film is attached to the display during production. Please remove this film before attempting to play the instrument.

④ ① ② ③ FUNCTION button

These buttons are used to select one of three functions/options shown at the bottom of the LCD display.

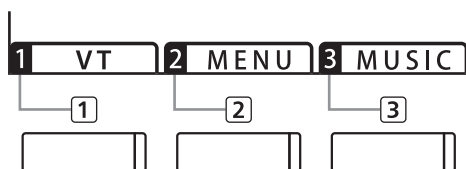

⑤ ARROW buttons

These buttons are used to navigate around the various menus and screens, adjust values, and answer on-screen prompts.

⑥ EFFECTS button

This button is used to turn effects for the selected sound on/off, to select the different effect types, and to adjust their settings.

⑦ REVERB button

This button is used to turn reverb for the selected sound on/off, to select the different reverb types, and to adjust their settings.

⑧ METRONOME button

This button is used to turn the metronome function on/off, and to adjust the tempo, time signature/beat, and volume settings.

⑨ PLAY/STOP button

This button is used to start/stop the playback of demonstration songs, Piano Music pieces, and Lesson and Finger Exercises, and to start/stop the recording and playback of recorder songs, and MP3/WAV audio files.

⑩ REC button

This button is used to record performances to internal memory or a USB memory device as MP3/WAV audio files.

⑪ SOUND buttons

These buttons are used to select the sound(s) that will be heard when playing the keyboard of the CN39 digital piano. Multiple sounds are assigned to each category button, and can be selected by pressing the same button repeatedly.

These buttons are also used to select Registration memories.

⑫ REGISTRATION button

This button is used to store and recall one of the sixteen different registration memories. Each registration can store sound, reverb and effects settings, as well as various other panel options.

⑬ PHONES jacks

These jacks are used to connect stereo headphones to the CN39 digital piano. 1/4" and 1/8" connectors are provided for convenience, and both can be used simultaneously, allowing two pairs of headphones to be connected at the same time.

⑭ USB to DEVICE port

This port is used to connect a FAT or FAT32 formatted USB memory device to the instrument in order to load/save recorded song data, registration memories, and MP3/WAV/SMF files etc.

⑮ PEDAL connector

This connector is used to connect the pedal board to the piano.

⑯ DC IN 15V connector

This connector is used to connect the power adaptor to the piano.

⑰ USB to HOST port

This port is used to connect the CN39 digital piano to a computer using a USB 'B to A' type cable in order to send and receive MIDI data.

⑱ MIDI IN / OUT jacks

These jacks are used to connect the CN39 digital piano to external MIDI devices such as other musical instruments or a computer in order to send and receive MIDI data.

* For more information about the instrument's connectors and jacks, please refer to 'Connecting to Other Devices' on page 135.

⑲ LINE IN jacks

These jacks are used to connect the stereo output (Left/Right 1/4" phone plug) from audio equipment, computers, or other electronic instruments to the CN39 digital piano's amplifier and speakers.

⑳ LINE OUT jacks

These jacks are used to connect the stereo output (Left/Right 1/4" phone plug) of the CN39 digital piano to external amplifiers, mixers, recording devices, and similar equipment.

Setting Up the Piano

1 Power

1. Connecting the power adaptor to the instrument

Connect the AC power adaptor to the DC IN terminal located on the underside of the instrument, as indicated below.

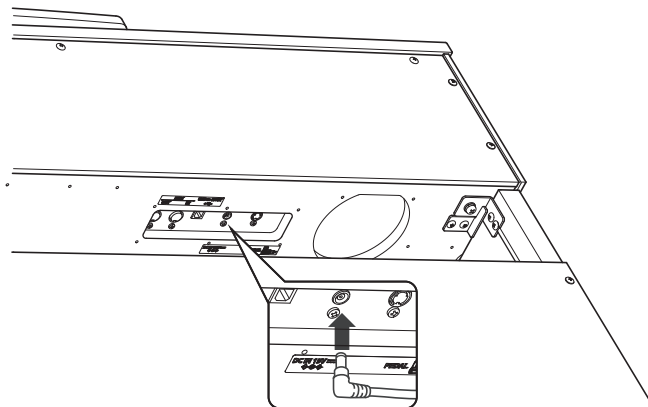

2. Connecting the power adaptor to an outlet

Connect the AC power adaptor to an AC outlet.

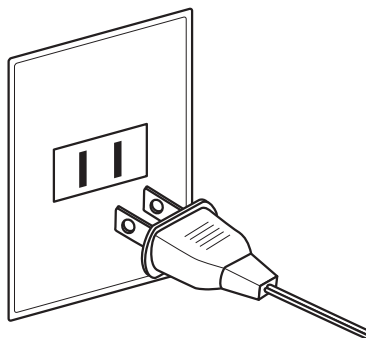

3. Turning on the power

Press the [POWER] button, located on the right hand side of the instrument's front panel.

The instrument will turn on, and the words 'SK Concert Grand' will be shown in the display, indicating that the SK Concert Grand sound is selected, and the instrument is ready to be played.

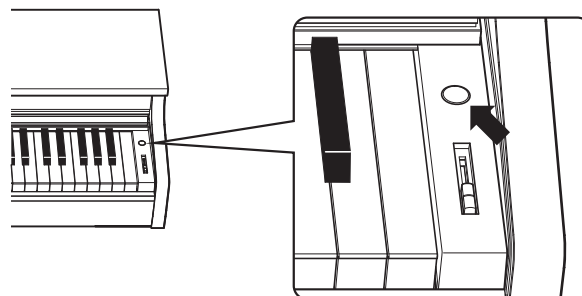

* The CN39 digital piano incorporates power saving features that can turn off the display and the instrument automatically after a specified period of inactivity. For more information, please refer to the 'Auto Display Off' and 'Auto Power Off' settings on pages 81 and 82.

2 Key cover and music rest

■ Opening the key cover

Gently lift the key cover with both hands, then slowly push it back, into the instrument's body.

To close the key cover, slowly pull the handle with both hands, then gently lower it downward.

* Please close the lid slowly in order to avoid injury.

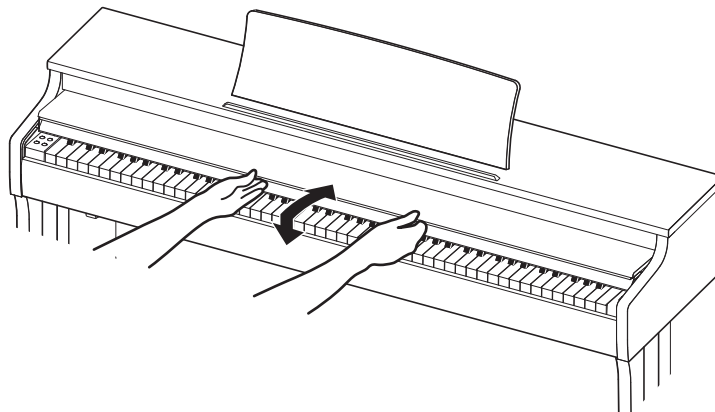

■ Adjusting the music rest

Lift the music rest, then lower the metal prop (rear side) into the recessed holder to set the desired music rest angle.

* The music rest can be set to one of three different angle positions.

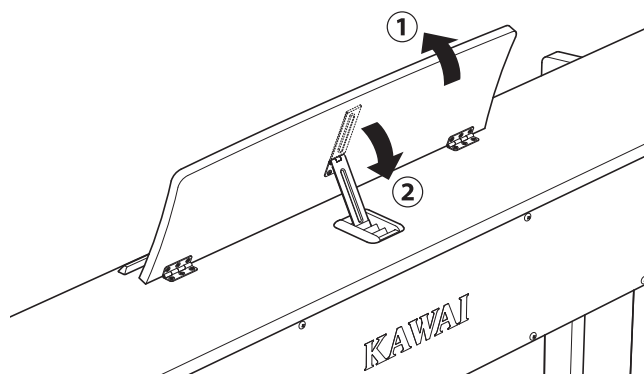
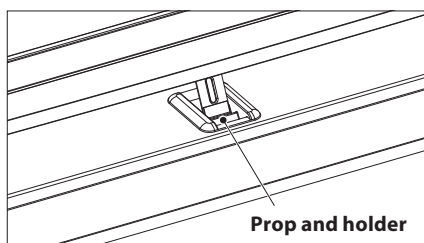

To lower the music rest, gently lift the prop from the recessed holder, then lower the music rest.

* Please lower the music rest slowly in order to avoid injury.

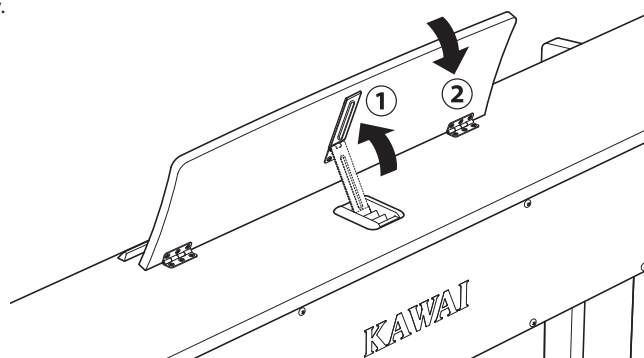

3 Volume and headphones

■ Adjusting the volume

The [MASTER VOLUME] slider controls the volume level of the instrument's speakers, or headphones if connected.

Move the slider up to increase the volume, and down to decrease the volume.

Use this slider to set the volume to a comfortable listening level – the middle is often a good starting point.

* The MASTER VOLUME slider will also affect the volume level of the LINE OUT connectors.

* The maximum volume level of the speakers can be reduced by using the 'Speaker Volume' setting. Please refer to page 74 for more information.

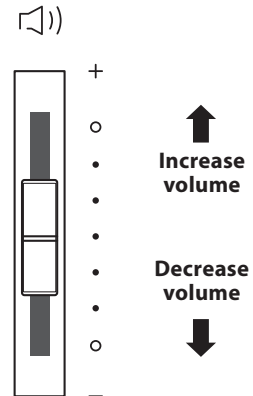

■ Using headphones

Use the jacks located beneath the keyboard on the left hand side, to connect stereo headphones to the CN39 digital piano. 1/4" and 1/8" connectors are provided for convenience.

Two pairs of headphones can be connected and used simultaneously.

When a pair of headphones is connected, sound will not be produced by the speakers. In addition, the headphones icon will appear at the top of the display.

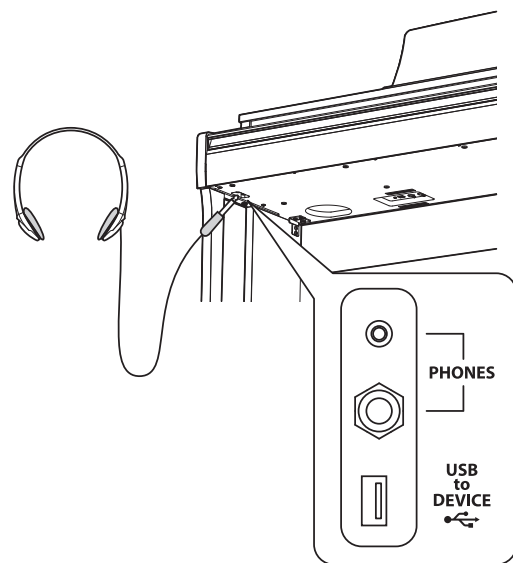

■ Attaching the headphone hook (optional)

A headphone hook is included with the CN39 digital piano and can be used to hang headphones when not in use.

If desired, attach the headphone hook to the underside of the keyboard as shown in the illustration opposite.

* For more information, please refer to the 'Assembly Instructions' on page 131.

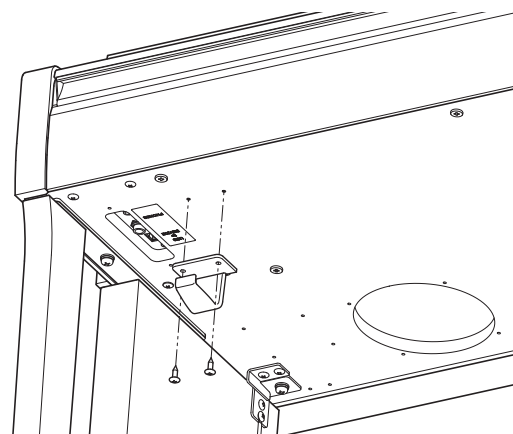

4 Pedals

As with a grand piano, the CN39 digital piano features three pedals: sustain, sostenuto, and soft.

■ Sustain pedal (right pedal)

Depressing this pedal sustains the sound after one's hands have been lifted from the keyboard – greatly enriching the piano sound, while also assisting smooth 'legato' passages.

The sustain pedal is capable of responding to half pedaling.

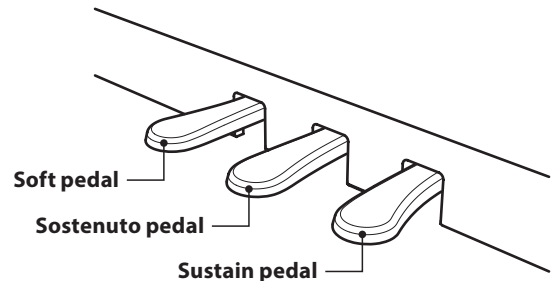

■ Soft pedal (left pedal)

Depressing this pedal softens the sound, reducing its volume.

When the Jazz Organ sound is selected, the soft pedal is also used to alternate the speed of the rotary simulation between 'Slow' and 'Fast' effect modes.

■ Sostenuto pedal (centre pedal)

Depressing this pedal after playing the keyboard and before releasing the keys, sustains the sound of only those notes that have been played. Any keys that are subsequently played after the sostenuto pedal is depressed will not be sustained.

■ Pedal support bolt

A pedal support bolt is attached at the base of the pedal board to aid stability when the pedals are pushed.

Turn the bolt anti-clockwise until it makes contact with the floor and supports the pedals firmly. If the pedal support bolt does not make contact with the floor, the pedal board may become damaged.

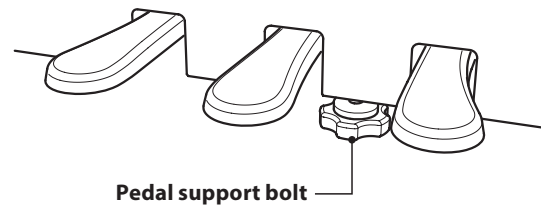

When moving the instrument, always adjust or remove the pedal support bolt, then readjust when the instrument is in its new position.

■ Caring for the pedals

If the surface of the pedals becomes dirty, clean the pedals using a dry dish-washing sponge. Do not attempt to clean the pedals using rust-removing solvents, abrasives or files.

■ Grand Feel Pedal System

The CN39 digital piano features the Grand Feel Pedal System, which replicates the sustain, soft, and sostenuto pedal weighting of a Shigeru Kawai SK Concert Grand piano.

Selecting Sounds

The CN39 digital piano features a wide selection of realistic instrument sounds suitable for various musical styles. Sounds are arranged into eight categories, with several sounds assigned to each category button. For a complete listing of available instrument sounds, please refer to page 9 of the MIDI Settings manual.

By default, the 'SK Concert Grand' sound will be selected automatically when the instrument is turned on.

Selecting a sound

Press the desired SOUND button.

The LED indicator for the button will turn on to indicate that this category has been selected, and the name of the sound will be shown in the LCD display.

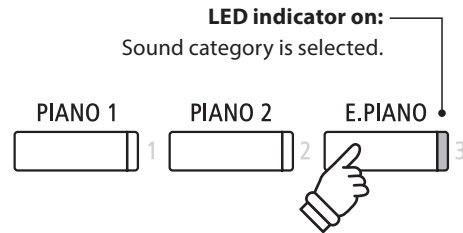

Example: To select the E.PIANO category, press the E.PIANO button.

Changing the sound

Several sounds are assigned to each category button.

Press the selected category button repeatedly to cycle through the different sound variations.

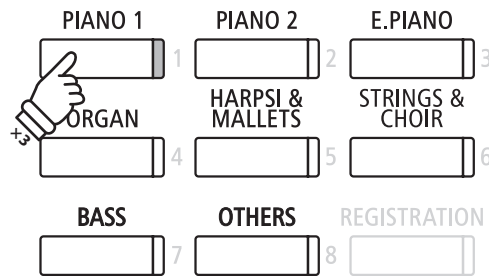
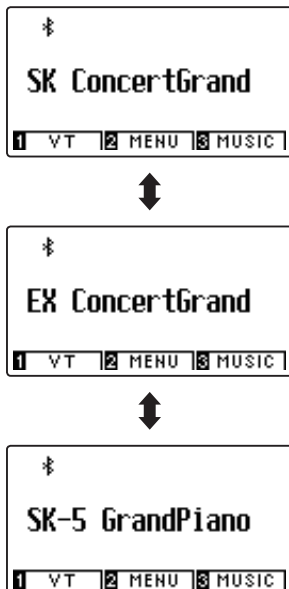

Example: To select the 'SK-5 Grand Piano' sound, press the PIANO 1 button three times.

The ◀ or ▶ buttons can also be used to select sounds and cycle through the different sound variations.

* When selecting sounds assigned to the OTHERS category button, pressing and holding the ◀ button then pressing the ▶ button (and vice versa), can be used to cycle through the various sub-categories more quickly.



Dual Mode

The Dual Mode function allows two sounds to be layered together, creating a more complex sound. For example, a piano sound layered with strings, or a church organ combined with a choir, etc.

1. Entering Dual mode

Press and hold a SOUND button to select the main sound, then press another SOUND button to select the layered sound.

The LED indicators for both SOUND buttons will turn on to indicate that Dual Mode is in use, and the respective sound names will be shown in the LCD display.

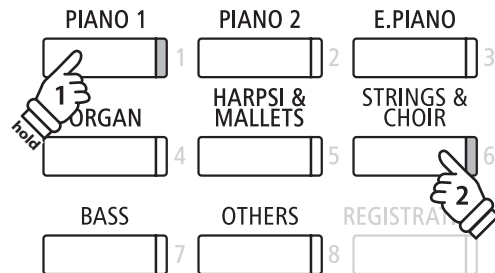
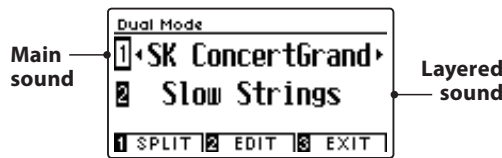

2a. Changing the main/layered sounds: Method 1

To select a different variation for the layered sound:

Press and hold the main SOUND button, then press the layered SOUND button repeatedly to cycle through the different sound variations.

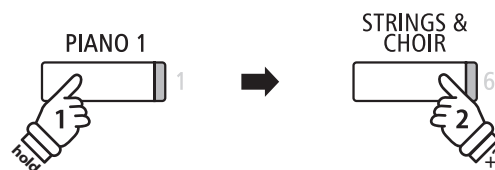
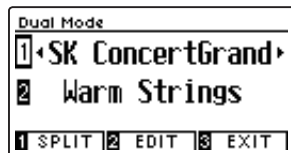

Example: To change the layered 'Slow Strings' sound to the 'Warm Strings' sound, press and hold the PIANO 1 button, then press the STRINGS button twice.

To select a different variation for the main sound:

Press and hold the layered SOUND button, then press the main SOUND button repeatedly to cycle through the different sound variations.

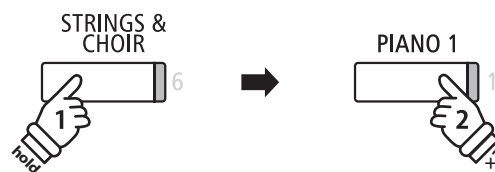

Example: To change the main 'SK Concert Grand' sound to the 'Mellow Grand' sound, press and hold the STRINGS button, then press the PIANO 1 button three times.

2b. Changing the main/layered sounds: Method 2

It is also possible to change the main/layered sound without pressing and holding buttons.

Press the ▼ or ▲ buttons to move the selection cursor over the main sound or layered sound.

Press the ◀ or ▶ buttons to cycle through the different sound variations.

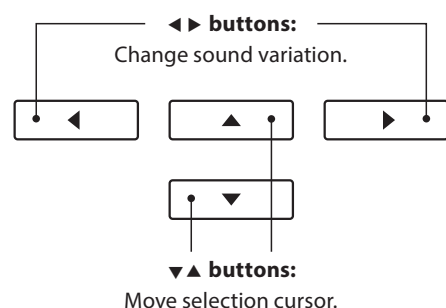

Dual Mode settings

The Dual Mode settings menu allows characteristics of the combined sound to be adjusted.

Dual Mode settings

Dual Mode setting	Description	Default setting
Balance	Adjust the volume balance between the main and layered sounds.	9 - 9
Layer Octave Shift	Raise/lower the pitch of the layered sound in octave steps.	0
Dynamics	Adjust the dynamic sensitivity of the layered sound relative to the main sound.	10

Entering the Dual Mode settings menu

While the Dual Mode screen is shown in the LCD display:

Press the **[2]** FUNCTION button (EDIT).

The Dual Mode settings menu will be shown in the LCD display.

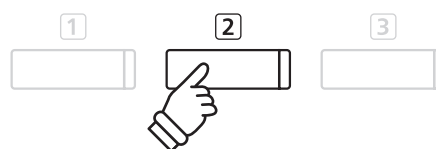
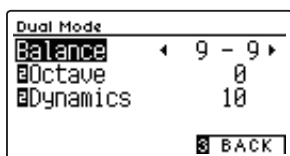

* Preferred Dual Mode settings can be stored to a Registration memory for convenient recall, or to the Startup Setting memory for automatic selection when the instrument is turned on. Please refer to pages 35 and 79 for more information.

Adjusting Dual Mode settings

After entering the Dual Mode settings menu:

Press the **▼** or **▲** buttons to move the selection cursor over the desired setting.

Press the **◀** or **▶** buttons to adjust the selected setting.

* To reset the current setting to the default value, press the **◀** and **▶** buttons simultaneously.

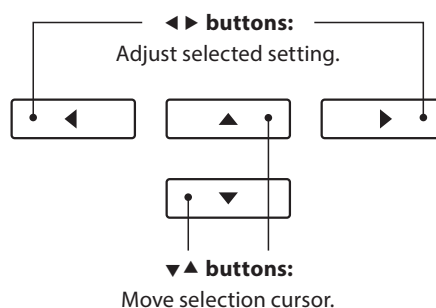

Cycling between Dual, Split, and Four Hands modes

When Dual Mode is selected, press the **[1]** FUNCTION button to cycle between Split, Four Hands, and Dual modes.

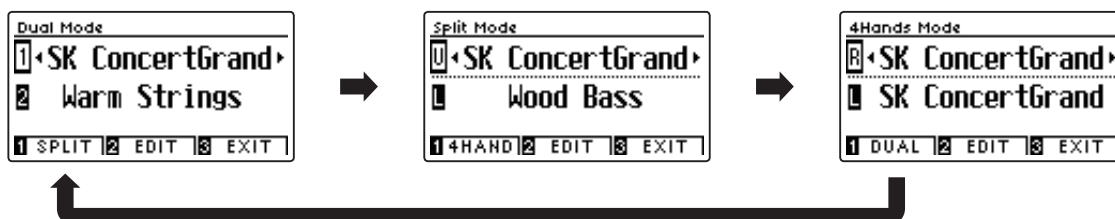

Exiting Dual, Split, and Four Hands modes

Press the **[3]** FUNCTION button (EXIT) to exit Dual, Split, and Four Hands modes.

Split Mode

The Split Mode function divides the keyboard into two sections, allowing each section to be played with a different sound. For example, a bass sound in the lower section, and a piano sound in the upper section.

1. Entering Split mode

After entering Dual Mode (page 20):

Press the **1** FUNCTION button (SPLIT).

The Split Mode screen will be shown in the LCD display.

* The default split point is set between keys B3 and C4.

The upper section and lower section sound names will be shown in the LCD display. The LED indicator for the upper section sound button will turn on, and the LED indicator for the lower section sound button will start to flash.

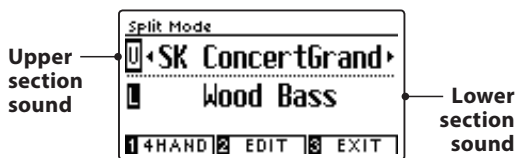

* By default, the lower section will be set to the 'Wood Bass' sound.

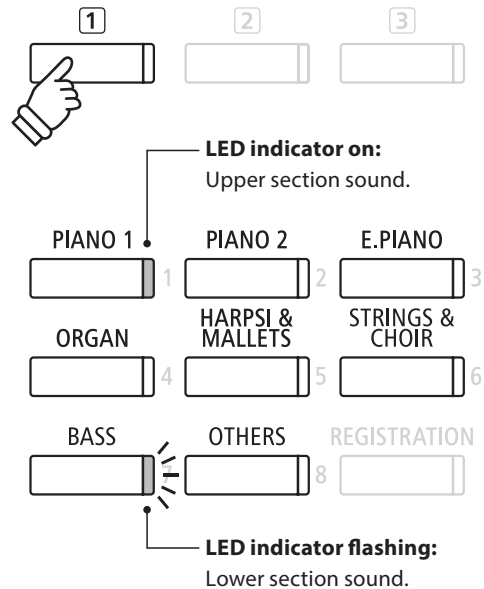

2a. Changing the upper/lower section sounds: Method 1

To select a different sound for the upper section:

Press the desired SOUND button.

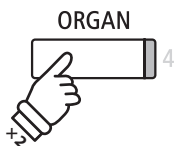

Example: To select the 'Blues Organ' sound for the upper section, press the ORGAN button twice.

* Preferred Split Mode upper/lower section sound combinations can be stored to a Registration memory for convenient recall. Please refer to page 35 for more information.

To select a different sound for the lower section:

Press and hold the **1** FUNCTION button (4HAND), then press the desired SOUND button.

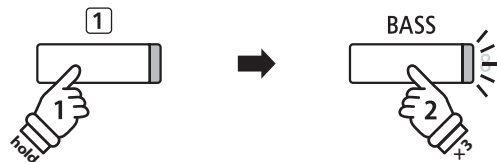

Example: To select the 'W. Bass & Ride' sound for the lower section, press and hold the 1 FUNCTION button, then press the BASS button three times.

2b. Changing the upper/lower section sounds: Method 2

It is also possible to change the upper/lower section sound without pressing and holding buttons.

Press the **▼** or **▲** buttons to move the selection cursor over the upper section or lower section sound.

Press the **◀** or **▶** buttons to cycle through the different sound variations.

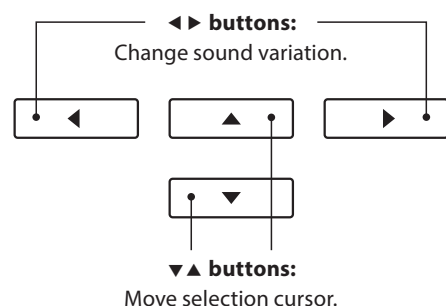

3. Changing the split point

Press and hold the [1] FUNCTION button (4HAND), then press the desired split key on the keyboard.

The name of the pressed key will briefly be shown in the LCD display, and will become the new split point.

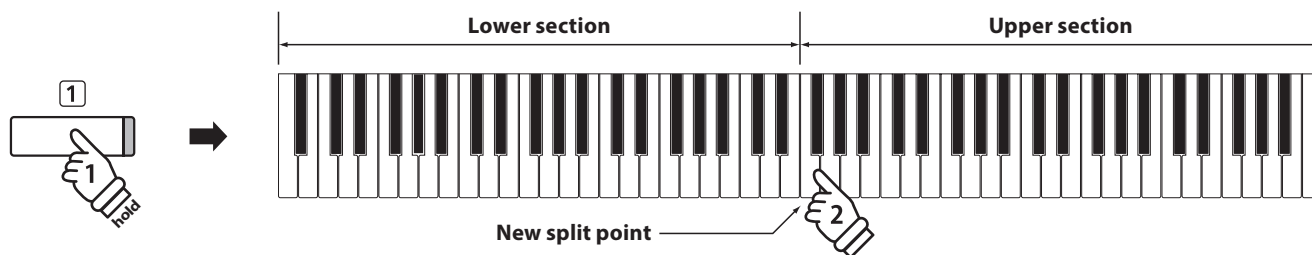
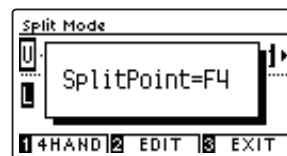

Split Mode settings

The Split Mode settings menu allows characteristics of the Split Mode sound and operation to be adjusted.

Split Mode settings

Split Mode setting	Description	Default setting
Balance	Adjust the volume balance between the upper and lower sections.	9 - 9
Lower Octave Shift	Raise/lower the pitch of the lower section sound in octave steps.	0
Lower Pedal	Enable/disable the sustain pedal for the lower section sound.	Off
Split Point	Specify the point along the keyboard that divides the upper and lower sections.	C4

Entering the Split Mode settings menu

While the Split Mode screen is shown in the LCD display:

Press the [2] FUNCTION button (EDIT).

The Split Mode settings menu will be shown in the LCD display.

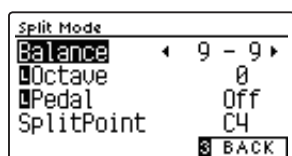
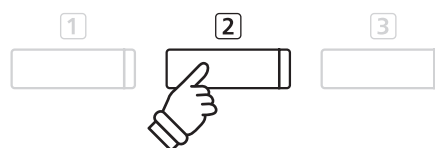

* Preferred Split Mode settings can be stored to a Registration memory for convenient recall, or to the Startup Setting memory for automatic selection when the instrument is turned on. Please refer to pages 35 and 79 for more information.

Adjusting Split Mode settings

After entering the Split Mode settings menu:

Press the ▼ or ▲ buttons to move the selection cursor over the desired setting.

Press the ◀ or ▶ buttons to adjust the selected setting.

* To reset the current setting to the default value, press the ◀ and ▶ buttons simultaneously.

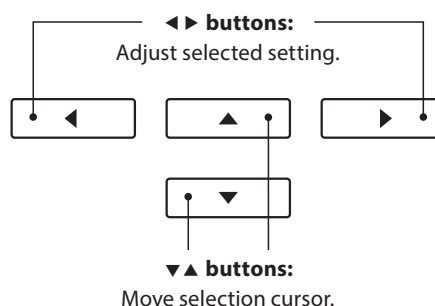

Four Hands Mode

The Four Hands Mode function divides the keyboard into two sections in a similar way to that of the Split Mode function. However, with Four Hands Mode enabled, the octave/pitch of each section is automatically adjusted to create two separate 44-key instruments with the same playing range. Furthermore, the sustain (right) pedal and soft (left) pedal act as separate sustain pedals for the respective upper and lower sections, allowing two people to perform piano duets using a single instrument.

1. Entering Four Hands mode

After entering Dual Mode (page 20):

Press the **1** FUNCTION button (SPLIT) once to enter Split Mode, then press the **1** FUNCTION button (4HAND) again to select Four Hands Mode.

* The default four hands mode split point is set between keys E4 and F4.

The Four Hands Mode screen and right/left section sound names will be shown in the LCD display.

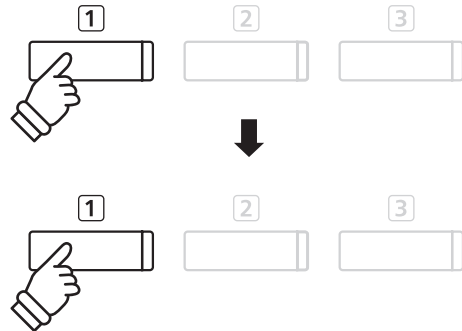
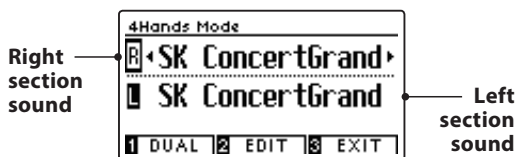

* By default, the right and left sections will both be set to the 'SK Concert Grand' sound.

2a. Changing the right/left section sounds: Method 1

To select a different sound for the right section:

Press the desired SOUND button.

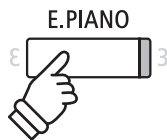

Example: To select the 'Classic E.Piano.' sound for the right section, press the E.PIANO button.

* Preferred Four Hands Mode right/left section sound combinations can be stored to a Registration memory for convenient recall. Please refer to page 35 for more information.

To select a different sound for the left section:

Press and hold the **1** FUNCTION button (DUAL), then press the desired SOUND button.

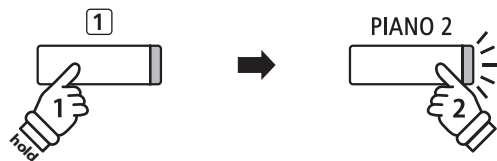

Example: To select the 'Upright Piano' sound for the left section, press and hold the 1 FUNCTION button, then press the PIANO2 button.

2b. Changing the right/left section sounds: Method 2

It is also possible to change the right/left section sound without pressing and holding buttons.

Press the **▼** or **▲** buttons to move the selection cursor over the right section or left section sound.

Press the **◀** or **▶** buttons to cycle through the different sound variations.

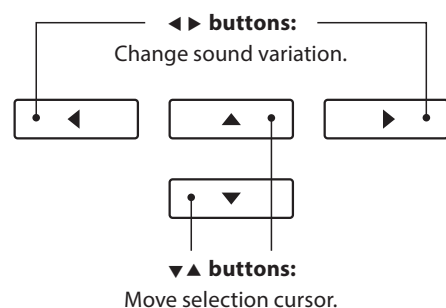

3. Changing the Four Hands mode split point

Press and hold the **[1]** FUNCTION button (DUAL), then press the desired split key on the keyboard.

The name of the pressed key will briefly be shown in the LCD display, and will become the new split point.

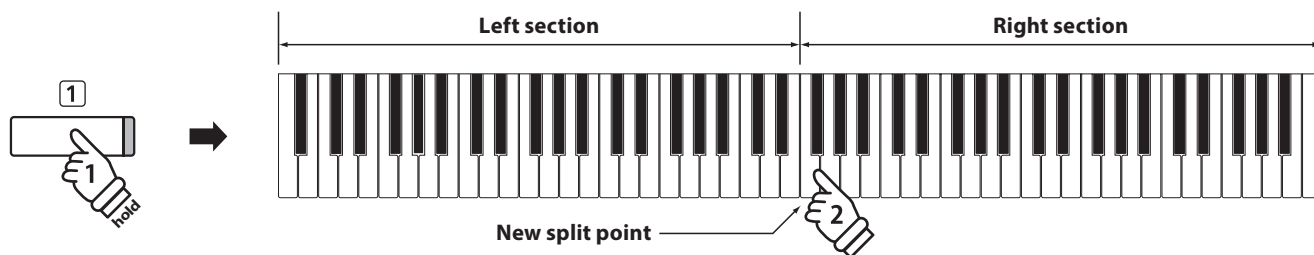
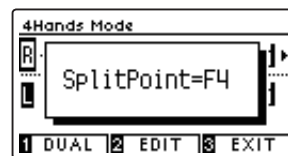

Four Hands Mode settings

The Four Hands Mode settings menu allows characteristics of the Four Hands Mode sound to be adjusted.

■ Four Hands Mode settings

Four Hands Mode setting	Description	Default setting
Balance	Adjust the volume balance between the upper and lower sections.	9 - 9
Right Octave Shift	Raise/lower the pitch of the right section sound in octave steps.	- 2
Left Octave Shift	Raise/lower the pitch of the left section sound in octave steps.	+ 2
Split Point	Specify the point along the keyboard that divides the right and left sections.	F4

■ Entering the Four Hands Mode settings menu

While the Four Hands Mode screen is shown in the LCD display:

Press the **[2]** FUNCTION button (EDIT).

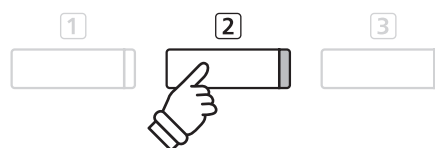

The Four Hands Mode settings menu will be shown in the LCD display.

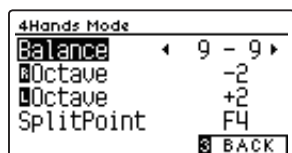

* Changes made to the Four Hands Mode settings will not affect the Split Mode settings, and vice versa.

* Preferred Four Hands Mode settings can be stored to a Registration memory for convenient recall, or to the Startup Setting memory for automatic selection when the instrument is turned on. Please refer to pages 35 and 79 for more information.

■ Adjusting Four Hands Mode settings

After entering the Four Hands Mode settings menu:

Press the **▼** or **▲** buttons to move the selection cursor over the desired setting.

Press the **◀** or **▶** buttons to adjust the selected setting.

* To reset the current setting to the default value, press the **◀** and **▶** buttons simultaneously.

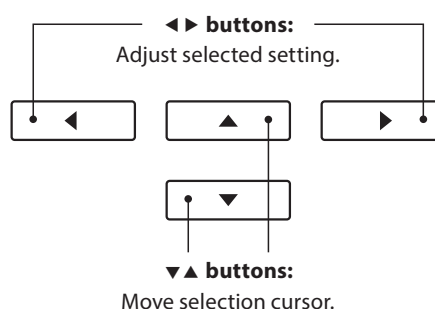

Reverb

Reverb adds reverberation to the sound, simulating the acoustic environment of a recital room, stage, or concert hall. Some sound types, such as acoustic piano, enable reverb automatically in order to improve acoustic realism. The CN39 digital piano features six different reverb types.

■ Reverb types

Reverb type	Description
Room	Simulates the ambience of a small rehearsal room.
Lounge	Simulates the ambience of piano lounge.
Small Hall	Simulates the ambience of a small hall.
Concert Hall	Simulates the ambience of a concert hall or theater.
Live Hall	Simulates the ambience of a live hall or stage.
Cathedral	Simulates the ambience of a large cathedral.

1. Turning Reverb on/off

Press the REVERB button to turn reverb on/off.

The LED indicator for the REVERB button will turn on to indicate when reverb is in use, and the current status will briefly be shown in the LCD display.

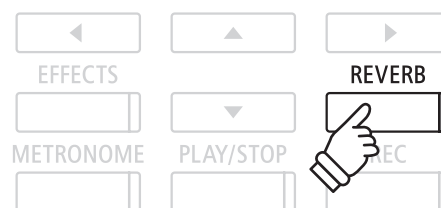
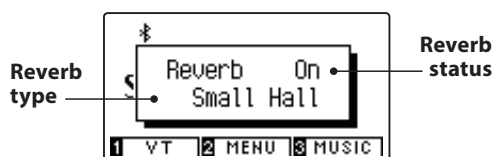

Reverb settings

The Reverb settings menu allows the type and characteristics of the reverb to be adjusted.

■ Reverb settings

Reverb setting	Description	Range
Type	Changes the type of environment.	–
Depth	Adjusts the depth of the environment (i.e. amount of reverberation to apply).	1~10
Time	Adjusts the decay length/speed of the reverberation.	1~10

■ Entering the Reverb settings menu

Press and hold the REVERB button.

The Reverb settings menu will be shown in the LCD display.

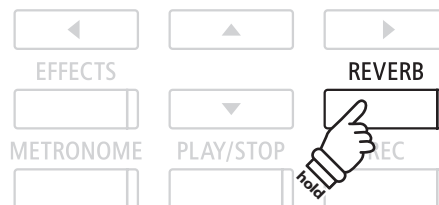
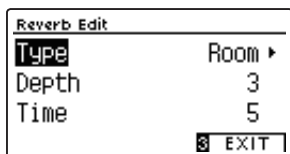

■ Adjusting Reverb settings

After entering the Reverb settings menu:

Press the ▼ or ▲ buttons to move the selection cursor over the desired setting.

Press the ◀ or ▶ buttons to adjust the selected setting.

* To reset the current setting to the default value, press the ◀ and ▶ buttons simultaneously.

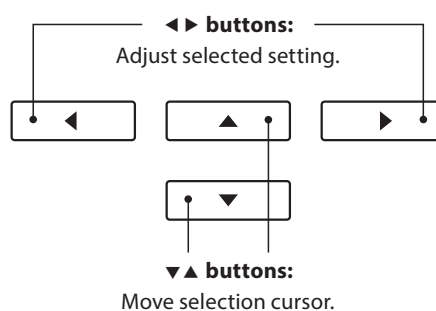

■ Exiting the Reverb settings menu

Press the [EXIT] FUNCTION button (EXIT) to exit the Reverb settings menu.

* Reverb settings are independent for each sound variation.

* Any changes made to the reverb type, settings, or on/off status will remain until the power is turned off.

* Preferred reverb settings can be stored to a Registration memory for convenient recall, or to the Startup Setting memory for automatic selection when the instrument is turned on. Please refer to pages 35 and 79 for more information.



Effects

In addition to reverb, various other effects can be applied to the selected sound, altering the tonal character and feeling of the instrument. As with reverb, some sound types enable certain effects automatically in order to enhance tonal quality. The CN39 digital piano features 19 different effect types, with 2 combination effects, and 3 additional amplified effects.

Effect types

Effect type	Description
Mono Delay	Applies an echo effect to the sound, playing through both speakers simultaneously.
Ping Delay	Applies a 'ping pong' echo effect to the sound, giving the impression that it is 'bouncing' from left to right.
Triple Delay	Similar in principle to Ping Delay, but with an additional centre echo.
Chorus	Layers a slightly detuned version of the sound over the original, thus enriching its tonal character.
Classic Chorus	Similar in principle to Chorus, but intended for vintage electric piano sounds.
Ensemble	Applies a three-phase chorus to the sound, providing additional richness.
Tremolo	Continuously varies the volume at a constant speed, adding a vibrato type effect to the sound.
Classic Tremolo	Similar in principle to Tremolo, but intended for vintage electric piano sounds.
Vibrato Tremolo	Similar in principle to Tremolo, but with an additional Vibrato effect applied.
Auto Pan	Alternates the sound output from left to right across the stereo field using a sine wave.
Classic Auto Pan	Similar in principle to Auto Pan, but intended for vintage electric piano sounds.
Phaser	Applies a cyclic phase change to the sound, giving the impression that the sound is moving.
Classic Phaser	Similar in principle to Phaser, but intended for vintage electric piano sounds.
Rotary (1~6)	Simulates the sound of a rotary speaker commonly used with vintage electronic organs. There are three different levels of overdrive, with and without a Chorus effect. * The soft pedal can be used to alternate the speed of the rotary simulation between 'Slow' and 'Fast' effect modes.
Combination Effects	Different combinations of the above effects, applied simultaneously. * Combination effect types: Phaser+Chorus, Phaser+AutoPan
Amplified Effects	A selection of the above effects, with a vintage electric piano speaker effect applied. * Amplified effect types: Tremolo+Amp, Auto Pan+Amp, Phaser+Amp

1. Turning Effects on/off

Press the EFFECTS button to turn effects on/off.

The LED indicator for the EFFECTS button will turn on to indicate when effects are in use, and the current status will briefly be shown in the LCD display.

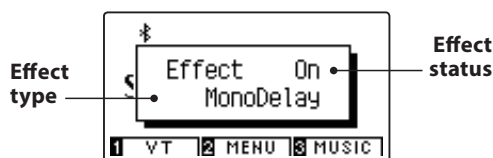

* If a drum kit sound is selected, the Effects Edit screen will not be shown.

Effects settings

Effect type	Effect setting	Description
Mono Delay / Ping Delay / Triple Delay	Dry / Wet	Adjust the intensity of the delay.
	Time	Adjust the interval of time between each delay.
Chorus / Ensemble	Dry / Wet	Adjust the intensity of the chorus.
	Speed	Adjust the speed of the chorus.

■ Effects settings (cont.)

Effect type	Effect setting	Description
Classic Chorus	Mono / Stereo	Toggle between a Mono or Stereo effect.
	Speed	Adjust the speed of the chorus.
Tremolo / Classic Tremolo / Vibrato Tremolo	Dry / Wet	Adjust the intensity of the tremolo.
	Speed	Adjust the speed of the tremolo.
Auto Pan / Classic Auto Pan	Dry / Wet	Adjust the intensity of the pan.
	Speed	Adjust the speed of the pan.
Phaser / Classic Phaser	Dry / Wet	Adjust the intensity of the phaser.
	Speed	Adjust the speed of the phaser.
Rotary	Accel. Speed	Adjust the acceleration speed between slow and fast modes.
	Rotary Speed	Adjust the speed of the rotary speaker.
Combination Effects / Amplified Effects	Dry / Wet	Adjust the intensity of the effects.
	Speed	Adjust the speed of the effects.

■ Entering the Effects settings menu

Press and hold the EFFECTS button.

The Effects settings menu will be shown in the LCD display.

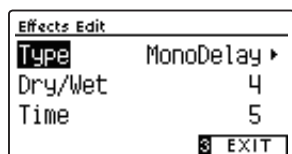

* If a drum kit sound is selected, the Effects Edit screen will not be shown.

■ Adjusting Effects settings

After entering the Effects settings menu:

Press the ▼ or ▲ buttons to move the selection cursor over the desired setting.

Press the ◀ or ▶ buttons to adjust the selected setting.

* To reset the current setting to the default value, press the ◀ and ▶ buttons simultaneously.

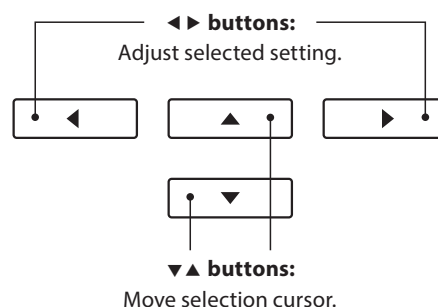

■ Exiting the Effects settings menu

Press the [EXIT] FUNCTION button (EXIT) to exit the Effects settings menu.

* Effects settings are independent for each sound variation.

* Any changes made to the effects type, settings, or on/off status will remain until the power is turned off.

* Preferred effects settings can be stored to a Registration memory for convenient recall, or to the Startup Setting memory for automatic selection when the instrument is turned on. Please refer to pages 35 and 79 for more information.



Virtual Technician

In addition to the reverb and effects functions, the overall character of the CN39 acoustic piano sounds can also be dramatically adjusted using the instrument's Virtual Technician feature. There are two methods of using the Virtual Technician: Smart Mode and Advanced Mode.

1 Smart Mode

In Smart Mode, the Virtual Technician intelligently performs a collection of adjustments for the player, based on ten preset attributes such as 'Soft' or 'Strong', 'Brilliant' or 'Dark'. This mode is recommended for musicians that wish to enjoy different piano characteristics, without delving into the individual parameters of Advanced Mode.

1. Entering Virtual Technician Smart Mode

While the normal playing mode screen is shown in the LCD display:

Press the **1** FUNCTION button (VT).

The Virtual Technician menu will be shown in the LCD display, and Smart Mode will be selected automatically.

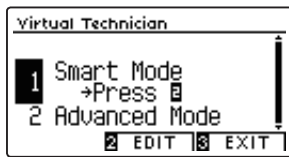

Press the **2** FUNCTION button (EDIT).

The list of Smart Mode presets will be shown in the LCD display.

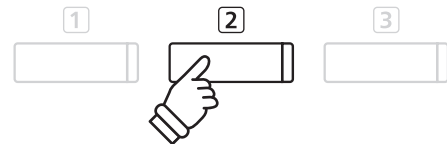

* Smart Mode will be disabled by default ('Off' preset). When disabled, the Advanced Mode Virtual Technician parameter settings will be used.

2. Selecting the Virtual Technician preset

While the Smart Mode presets screen is shown in the LCD display:

Press the ◀ or ▶ buttons to select the desired Virtual Technician Smart Mode preset.



The Virtual Technician adjustments will be applied to the selected sound immediately.

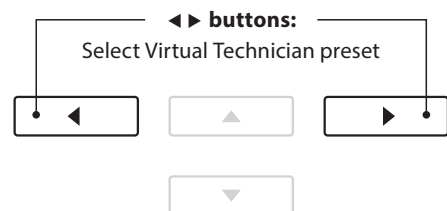

* Smart Mode presets are independent for each sound variation.

* The selected Smart Mode preset will be used for the current sound variation until the power is turned off. However, it is possible to store a Smart Mode preset to a sound. For more information, please refer to the instructions on the following page.

■ Showing the Virtual Technician Help screen

Press the **1** FUNCTION button (HELP).

A brief explanation about the currently selected Virtual Technician preset will be shown in the LCD display.

Press the **▼** or **▲** buttons to scroll through the explanation if necessary.



Press the **3** FUNCTION button (BACK) to return to the Virtual Technician preset selection screen.

■ Storing the Virtual Technician preset to the selected sound

After selecting the Smart Mode preset:

Press the **2** FUNCTION button (STORE).

The selected Smart Mode preset will be saved to the current sound variation, and a confirmation message will briefly be shown in the LCD display.

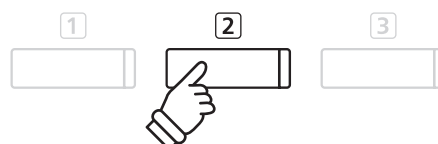

* The stored Smart Mode preset will be retained after the power is turned off, and will be used automatically whenever the sound variation is selected.

2 Advanced Mode

In Advanced Mode, the player is given full control over every aspect of the piano's configuration, allowing precise adjustments over hammer hardness, action regulation, cabinet size, and a variety of other acoustic characteristics. This mode is recommended for musicians that enjoy fine-tuning individual details of the piano sound in order to suit their personal preferences.

* For more information about the individual Virtual Technician parameters, please refer to page 83.

■ Entering Virtual Technician Advanced Mode

While the normal playing mode screen is shown in the LCD display:

Press and hold the **1** FUNCTION button (VT).

The Virtual Technician Settings menu will be shown in the LCD display, allowing parameters to be adjusted in Advanced Mode.

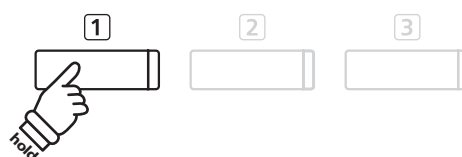

* It is also possible to access Advanced Mode via the Virtual Technician menu, or by selecting Virtual Tech. in the Function menus.

* It is also possible to make adjustments to a Smart Mode preset by selecting it, and then entering Advanced Mode. However, any adjustments cannot be re-stored back to the Smart Mode preset list.

Metronome / Drum Rhythms

The Metronome function provides a steady beat to aid practicing the piano at a consistent tempo. In addition to regular metronome beats, the CN39 digital piano also features a variety of drum rhythms to accompany most playing styles and musical genres.

For a complete listing of available drum rhythms, please refer to page 148 of this owner's manual.

Turning the Metronome on/off

Press the METRONOME button.

The LED indicator for the METRONOME button will turn on to indicate that the metronome function is in use, and a 4/4 beat will start to count.

The current metronome tempo in beats per minute (BPM) and beat of the bar will also be shown in the LCD display.

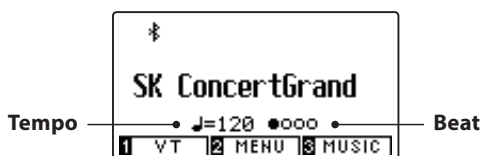

Press the METRONOME button again to stop the metronome. The LED indicator for the METRONOME button will turn off.

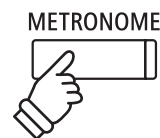

Metronome settings

The Metronome settings menu allows the tempo, beat, and volume of the metronome to be adjusted.

Metronome settings

Metronome setting	Description	Range
Tempo	Adjust the tempo of the metronome beat / drum rhythm in beats per minute (BPM).	10~400 bpm
Beat	Change the metronome beat (time signature) / drum rhythm. * There are ten different time signature available: 1/4, 2/4, 3/4, 4/4, 5/4, 3/8, 6/8, 7/8, 9/8, and 12/8.	-
Volume	Adjusts the volume of the metronome beat / drum rhythm.	1~10

Entering the Metronome settings menu

Press and hold the METRONOME button.

The Metronome settings menu will be shown in the LCD display.

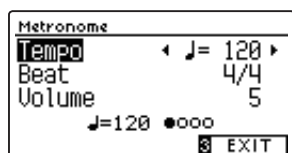

■ Adjusting Metronome settings

After entering the Metronome settings menu:

Press the ▼ or ▲ buttons to move the selection cursor over the desired setting.

Press the ◀ or ▶ buttons to adjust the selected setting.

* To reset the current setting to the default value, press the ◀ and ▶ buttons simultaneously.

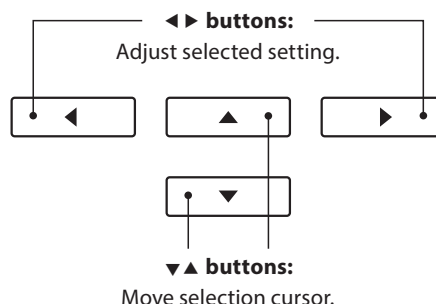

■ Drum rhythms

As an alternative to the simple metronome count, it is also possible to select a drum pattern from one of 100 different rhythm styles.

Enter the Metronome settings menu and select the Beat setting. Press the ◀ or ▶ buttons to cycle through the available beats until reaching the '8 Beat 1' drum rhythm.

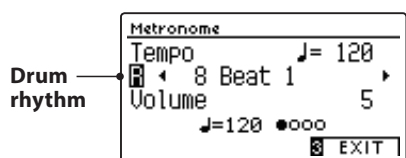

Continue to press the ◀ or ▶ buttons to select the desired drum rhythm.

* For a complete listing of available drum rhythms, please refer to page 148 of this owner's manual.

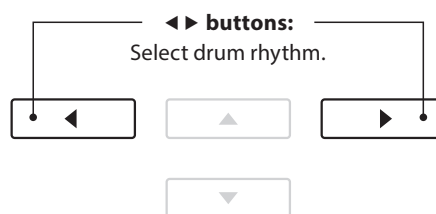

■ Exiting the Metronome settings menu

Press the [EXIT] FUNCTION button (EXIT) to exit the Metronome settings menu.

* Any changes made to the metronome tempo, beat, or volume settings will remain until the power is turned off.

* Preferred metronome settings can be stored to a Registration memory for convenient recall, or to the Startup Setting memory for automatic selection when the instrument is turned on. Please refer to pages 35 and 79 for more information.



■ Recording with the metronome

It is also possible to record songs with the metronome activated. This is useful when recording parts separately, or wishing to maintain correct timing throughout complex passages. Note that the standard metronome 'click' will not be heard when the song is played back.

* For more information about the instrument's Recorder function, please refer to page 50.

Registration Memories

The Registration function allows the current instrument setup (sound selections, split point, reverb and effect settings, and various other panel options) to be stored to a memory and conveniently recalled at the touch of a button. There are two banks ('A' and 'B') for each registration button, allowing up to 16 different registration memories to be stored.

Registrations can also be loaded/saved to a USB memory device. Please refer to pages 117/122 for more information.

■ Functions and Settings stored in Registration memories

Functions	Settings
Selected sound (including primary sound for each category)	Basic Settings (with exceptions)
Dual Mode / Split Mode / Four Hands Mode (including settings)	Virtual Technician Settings
Reverb, Effects (Type, Settings)	MIDI Settings
Metronome (Beat, Tempo, Volume)	

* Changes made to the Auto Power Off setting will be stored to User Memory automatically.

* For a complete listing of the settings that can be stored to Registration memories, please refer to pages 140~141.

1 Selecting a Registration memory

■ Entering Registration mode

Press the REGISTRATION button.



The LED indicator for the REGISTRATION button will turn on to indicate that the registration function is in use.

■ Selecting a Registration memory

When the registration function is in use:

Press the **1** FUNCTION button to toggle between registration memory bank 'A' and 'B'.

Press a SOUND button to select the desired registration memory.

The name of the selected registration memory will be shown in the LCD display.

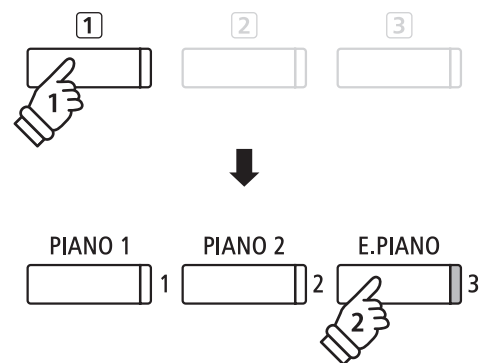
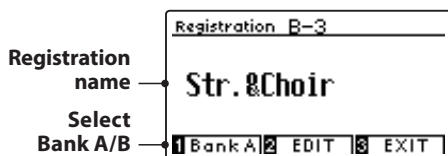

*Example: To select registration memory B-3 (when bank 'A' is selected), press the **1** FUNCTION button, then press the E.PIANO (memory 3) button.*

■ Exiting Registration mode

Press the REGISTRATION button.



The LED indicator for the REGISTRATION button will turn off, and the button panel will return to normal operation.

2 Storing a Registration memory

1. Entering Registration Store mode

While the normal playing mode screen is shown in the LCD display:

Press and hold the REGISTRATION button.

The registration memory (SOUND) buttons will start to flash.



2. Selecting the Registration memory

Press the ① or ② FUNCTION buttons to select the registration memory bank 'A' and 'B', then press a registration memory (SOUND) button.

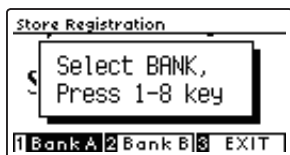

The Registration name screen will be shown in the LCD display.

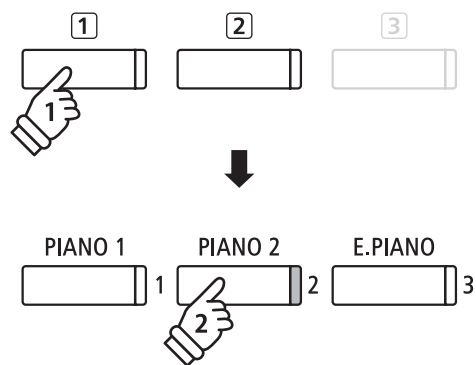

Example: To store the current instrument setup to memory A-2, press the ① FUNCTION button, then press the PIANO 2 (memory 2) button.

3. Naming the Registration memory

Enter a name for the registration memory by pressing the ▼ or ▲ buttons to cycle through the alphanumeric characters, and the ◀ or ▶ buttons to move the cursor.

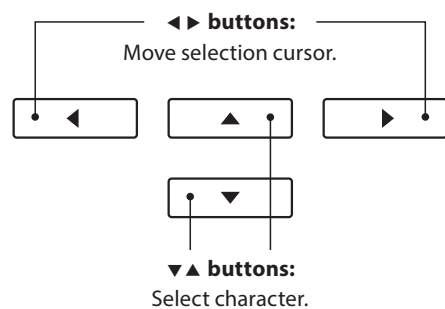

4. Storing the Registration to memory

Press the ② FUNCTION button (STORE) to confirm the store operation, or the ③ FUNCTION button (EXIT) to cancel.

Upon storing, a beep will sound and a confirmation message will briefly be shown in the LCD display.



The current instrument setup will be stored to the selected registration memory with the specified name.

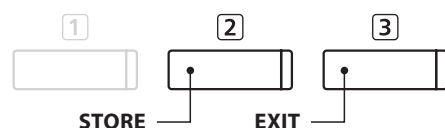

* The stored registration will remain in memory after the instrument is turned off, or if the instrument's power cable is disconnected from the wall outlet.

3 Registration Edit menu

The Registration Edit menu allows the currently selected registration memory to be opened in normal playing mode (for further adjustment, or simply to check which sounds are used etc.), or to be saved to USB memory.

■ Entering the Registration Edit menu

When the registration function is in use:

Press the **[2]** FUNCTION button (EDIT).

The Registration Edit menu will be shown in the LCD display.

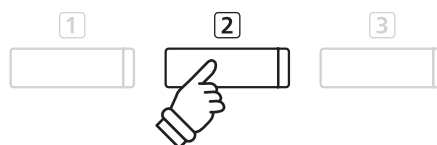

■ Opening the Registration

Press the **▼** or **▲** buttons to select the Open Registration function, then press the **[2]** FUNCTION button (OK).



The currently selected registration memory will be opened in normal playing mode, allowing additional changes and adjustments to be made.



▼▲ buttons:
Move selection cursor.

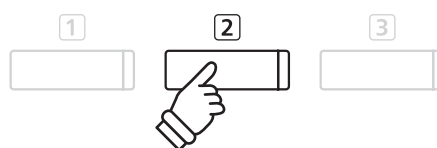
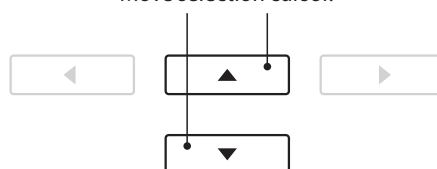

* For more information about storing the adjusted registration, please refer to page 35.

■ Saving the current Registration memory to USB

Press the **▼** or **▲** buttons to select the Save Registration function, then press the **[2]** FUNCTION button (OK).

The Save Regist Single function of the USB Menu will be shown in the LCD display, with the current registration selected.



* Please refer to the Save Registration Single instructions on page 122.

▼▲ buttons:
Move selection cursor.

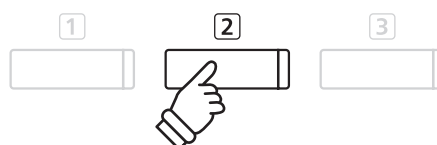
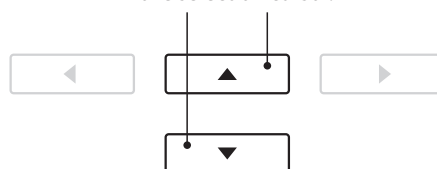

■ Resetting all Registration memories

Press and hold the REGISTRATION and REC buttons, then turn the instrument's power off/on. All registrations will be reset to the factory default settings.

Panel Lock

The Panel Lock function allows the state of all panel buttons to be temporarily locked, preventing sounds and other settings from being changed. This function may prove useful in teaching environments, ensuring that students are not distracted by changing sounds etc.

1. Activating the Panel Lock

While the normal playing mode screen is shown in the LCD display:

Press the ▼ and ▲ buttons simultaneously.

The Panel Lock screen will be shown in the LCD display, and the instrument will stop responding to panel button presses.

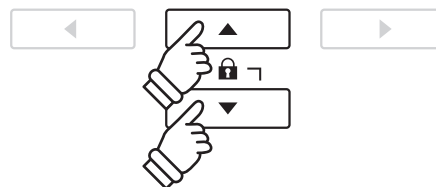
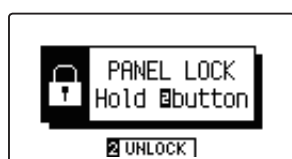

- * The Panel Lock can only be activated from the main playing screen.
- * When activated, the Panel Lock will remain until the power is turned off, or the lock is deactivated.
- * While Panel Lock is activated, the LED indicators for all buttons will turn off, however the LED indicator for the [FUNCTION] button will flash.

2. Deactivating the Panel Lock

While the Panel Lock is activated:

Press and hold the [FUNCTION] button (UNLOCK).

The Panel Lock will be deactivated, and the instrument will resume responding to panel button presses as normal.

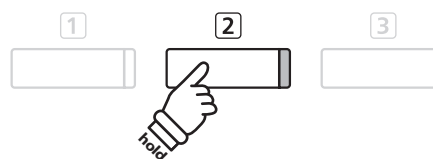

Demo Songs

The Demo function provides an excellent introduction to the varied capabilities of CN39 digital piano. There are over 30 different demonstration songs available, highlighting the instruments' rich selection of high quality sounds and its power speaker system.

For a complete listing of demonstration songs, please refer to page 139 of this owner's manual.

■ Entering Demo mode

Press the **[3]** FUNCTION button (MUSIC).

The Music Menu will be shown in the LCD display. Demo mode will be selected automatically.



Press the **[2]** FUNCTION (ENTER) or PLAY/STOP buttons.

The LED indicator for the PIANO 1 button will start to flash, and the 'SK Concert Grand' demo song will start to play.

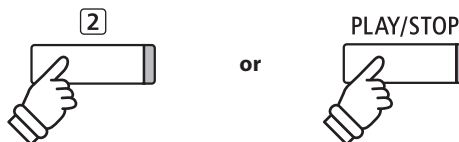

■ Selecting a demo song

While Demo mode is selected:

Press a SOUND button to select a sound category. The first demo song of the sound category will start to play.

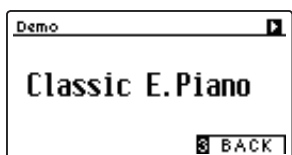

Press the ◀ or ▶ buttons to cycle through the demo songs in the selected sound category, and the ▼ or ▲ buttons to cycle through the different sound categories.

* When the selected song has finished, the next demo song in the category will begin to play automatically.

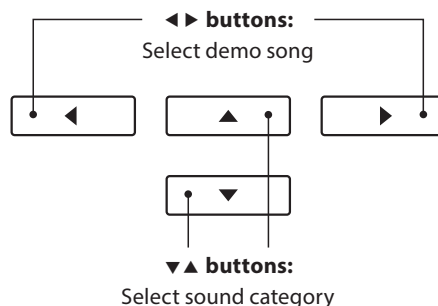
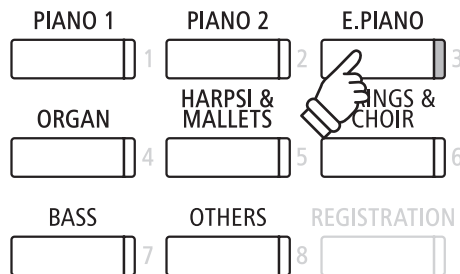

■ Stopping the demo song and exiting Demo mode

Press the **[3]** FUNCTION (BACK) or PLAY/STOP buttons while the song demo is playing.

The LED indicator for the selected SOUND button will stop flashing, and the song demo will stop playing.

Press the **[3]** FUNCTION (EXIT) button to exit the Music Menu.



Piano Music

In addition to the sound demonstration songs, the CN39 digital piano also features a selection of popular classical piano works from the Baroque and Romantic periods. Notated scores are provided in the separate 'Classical Piano Collection' book*, assisting the musical appreciation and study of each piece.

* Depending on market location.

For a complete listing of Piano Music pieces, please refer to the separate 'Internal Song Lists' booklet.

■ Entering Piano Music mode

Press the **[3]** FUNCTION button (MUSIC), then press the **▼** or **▲** buttons to select Piano Music mode.



Press the **[2]** FUNCTION (ENTER) or PLAY/STOP buttons.

The LED indicator for the PIANO 1 button will start to flash, and the piece 'Tambourin' by Rameau will start to play.

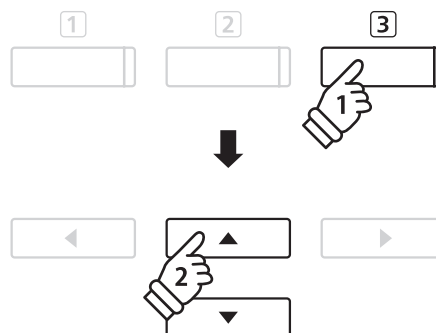

■ Selecting a piano music piece

While Piano Music mode is selected:

Press the **▼** or **▲** buttons to cycle through the different piano music pieces.

The title and composer of the selected piece will be shown in the LCD display.

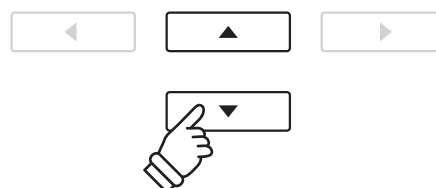
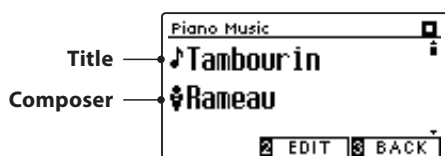

* The balance of the left hand and right hand parts can be adjusted by pressing the **[2]** FUNCTION (EDIT) button, and adjusting the Balance setting.

■ Replaying the selected piano music piece

When the selected piano music piece has finished:

Press the PLAY/STOP button to replay the piano music piece.



■ Stopping the piano music piece and exiting Piano Music mode

Press the **[3]** FUNCTION (BACK) or PLAY/STOP buttons while the piano music piece is playing.

The LED indicator for the PLAY/STOP button will turn off, and the piano music piece will stop playing.

Press the **[3]** FUNCTION (EXIT) button to exit the Music Menu.



Lesson Function

The Lesson function allows budding pianists to practice the piano using a selection of built-in song books and finger exercises. The left and right hand parts of each piece can be practiced separately, adjusting the tempo to perfect difficult passages, before being recorded for self-evaluation.

Built-in lesson mode song books

Alfred Lesson Books	Classical Lesson Books
Alfred's Premier Piano Course Lesson 1A	Burgmüller 25 (25 Etudes Faciles, Opus 100)
Alfred's Premier Piano Course Lesson 1B	Czerny 30 (Etudes de Mécanisme, Opus 849)
Alfred's Basic Piano Library Lesson Book Level 1A	Czerny 100 (Hundert Übungsstücke, Opus 139)
Alfred's Basic Piano Library Lesson Book Level 1B	Beyer 106 (Vorschule im Klavierspiel, Opus 101)
Alfred's Basic Adult Piano Course Lesson Book Level 1	J.S. Bach: Inventionen
	Sonatinen Album 1
	Chopin Walzer (Chopin waltzes series 1-19)

* Lesson books sold separately – please refer to the separate 'Internal Song Lists' booklet for more information.

1 Selecting a lesson book/song

1. Entering lesson mode

Press the **[3]** FUNCTION button (MUSIC), then press the **▼** or **▲** buttons to select Lesson Mode.



Press the **[2]** FUNCTION button (ENTER) to enter lesson mode.

The name of the selected lesson book, song, and current bar will be shown in the LCD display.

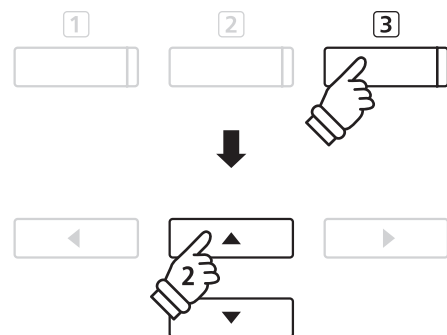

2. Selecting a lesson book/song

Press the **▼** or **▲** buttons to move the selection cursor over the lesson book name or song title.

Press the **◀** or **▶** buttons to cycle through the different lesson books and song titles.

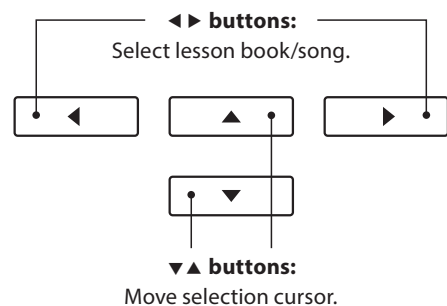
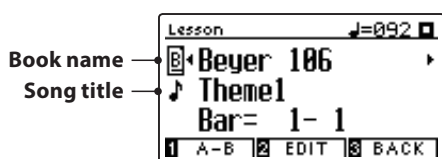

It is also possible to select songs by pressing and holding the **[2]** FUNCTION button (EDIT), then pressing the relevant key on the keyboard.

* Please refer to the separate 'Internal Song Lists' booklet for a complete listing of available lesson books/songs and corresponding key numbers.

2 Listening to the selected lesson song

This page will explain how to play and stop the selected lesson song, and change the playback position.

1. Playing the lesson song

After selecting a lesson book and song:

Press the PLAY/STOP button.

The LED indicator for the PLAY/STOP button will turn on, and a one bar count-in will be heard before the song starts to play.

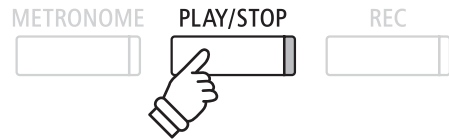
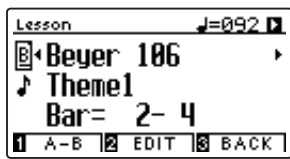

* If the first bar of the song begins on an 'up' beat (i.e. pickup notes), the first bar number will be shown as zero in the LCD display.

* The metronome will not continue after the count-in bar, but can be turned on manually by pressing the METRONOME button.

2. Changing the playback position (Bar)

Press the ▼ or ▲ buttons to move the selection cursor over the third line of the LCD display (Bar).

Press the ◀ or ▶ buttons to rewind or cue the playback position (Bar) of the current song.

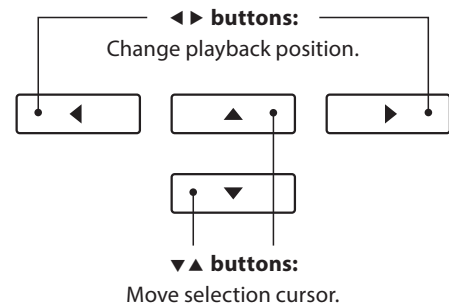

It is also possible to rewind or cue the playback position without selecting 'Bar', by pressing the REVERB or EFFECTS buttons.

To reset the playback position to the first bar of the song, press the REVERB and EFFECTS buttons simultaneously.



Stopping and resuming the lesson song

While the lesson song is playing:

Press the PLAY/STOP button to stop the lesson song playback.

Press the PLAY/STOP button once again to resume playback from the stopped position.

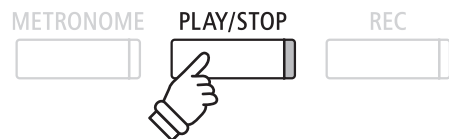

3. Exiting lesson mode

Press the [EXIT] FUNCTION (EXIT) button to exit the Music Menu.



3 Lesson Function settings

The Lesson Function settings menu allows the left and right-hand part volumes of the current lesson song to be adjusted, allowing each part to be practiced separately. It is also possible to adjust the playback tempo of the current lesson song, allowing difficult passages to be practised more conveniently.

■ Lesson Function settings

Lesson Function setting	Description	Default setting
Balance	Adjust the volume balance between the left and right-hand parts.	9 - 9
Tempo	Adjust the playback tempo of the current lesson song in beats per minute (BPM).	Song specific

■ Entering the Lesson Function settings menu

After selecting a lesson book and song:

Press the **2** FUNCTION button (EDIT).

The Lesson Function settings menu will be shown in the LCD display.

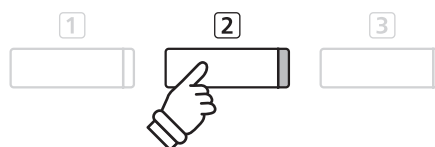

■ Adjusting the left/right-hand part volume

Press the **▼** or **▲** buttons to move the selection cursor over the Balance setting, then press the **◀** or **▶** buttons to adjust the volume of the left/right-hand part volume.

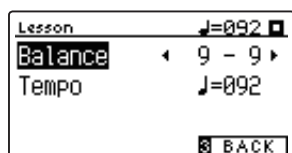

Increasing the volume of the left-hand part will reduce the volume of the right-hand part, and vice versa.

* If the Beyer lesson book is selected, increasing the left-hand value will decrease the volume of the student's part, while increasing the right-hand value will decrease the volume of the teacher's part.



Example: To practice the right-hand part while listening to the left-hand part, set the volume balance to 9 - 1.

■ Adjusting the playback tempo of the lesson song

Press the **▼** or **▲** buttons to move the selection cursor over the Tempo setting, then press the **◀** or **▶** buttons to adjust the playback tempo of the lesson song.

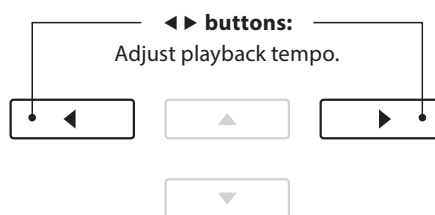
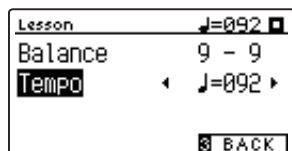

* To reset the playback tempo of the selected lesson song to the default value, press the **◀** and **▶** buttons simultaneously.

4 Repeating sections of a lesson song

The 'A-B Loop' feature of the Lesson Function allows sections of the selected lesson song to be 'looped' between two points in order to practise difficult passages continuously.

1. Playing the lesson song

After selecting a lesson book and song:

Press the PLAY/STOP button.

The LED indicator for the PLAY/STOP button will turn on, and a one bar count-in will be heard before the song starts to play.



2. Specifying the start point (A) of the loop

Press the **1** FUNCTION button (A-B) to specify the start point of the loop.

The LED indicator for the **1** FUNCTION button will start to flash, indicating that the start point (A) of the loop has been set.

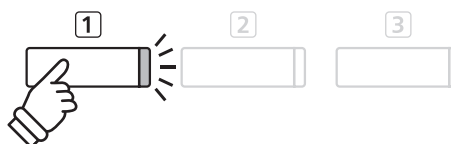

3. Specifying the end point (B) of the loop

Press the **1** FUNCTION button (A-B) again to specify the end point of the loop.

The LED indicator for the **1** FUNCTION button will turn on, indicating that the end point of the (B) of the loop has been set.



The defined 'A-B' section of the lesson song will repeat (loop), allowing the passage to be practiced continuously.

* The Balance and Tempo lesson function settings can continue to be adjusted while the A-B loop is in operation.

4. Cancelling the 'A-B' loop

Press the **1** FUNCTION button (A-B) once again to cancel the loop.

The LED indicator for the **1** FUNCTION button will turn off, and the lesson song will resume normal playback.



5 Recording a lesson song practice

The Lesson Function's Record feature allows the left or right-hand parts of the selected lesson song to be recorded to internal memory, and then played back for self-evaluation.

1. Starting the lesson song recording

After selecting a lesson book and song:

Press the REC button.

The LED indicators for the REC and PLAY/STOP buttons will turn on to indicate that recording mode is in use.

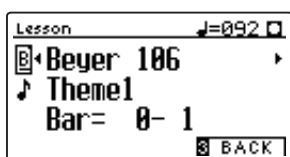

* It may be desirable to adjust the Balance and Tempo lesson function settings before starting the recording.

A one bar count-in will be heard before the lesson song starts to play and record.

2. Stopping the lesson song recording

Press the PLAY/STOP button.

The LED indicators for the REC and PLAY/STOP buttons will turn off, and the lesson song recording and playback will stop.



3. Playing back the recorded lesson song

Press the PLAY/STOP button again.

The LED indicator for the PLAY/STOP button will turn on, and a one bar count-in will be heard before the recorded lesson song starts to play.

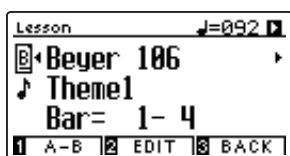

Press the PLAY/STOP button.

The LED indicator for the PLAY/STOP button will turn off, and the recorded lesson song will stop playing.

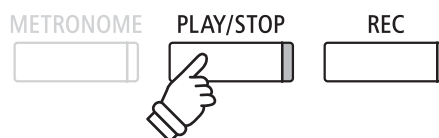

* The Balance and Tempo lesson function settings can continue to be adjusted while the recorded lesson song practise is playing.

* The 'A-B' loop function cannot be used when recording a lesson song practice.

* Press the REC and PLAY/STOP buttons simultaneously to erase the recorded lesson song practice. The recorded practice will be erased automatically when a different lesson song is selected.

6 Finger Exercises

The lesson function also includes a selection of finger exercises for practicing major and minor scales, arpeggios, chords, cadences, and Hanon exercises, with notated scores provided in the separate 'Finger Exercises' book.

The CN39 digital piano can also evaluate one's practice, analysing note accuracy, timing evenness, and note volume consistency, before displaying results for each category. Using this function, players can objectively review their performances, and concentrate on improving a particular area of their technique.

1. Selecting and recording a Hanon finger exercise

While Lesson mode is in use:

Select the Hanon lesson book, then select a song number.

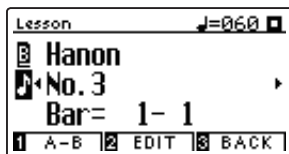

Press the REC button.

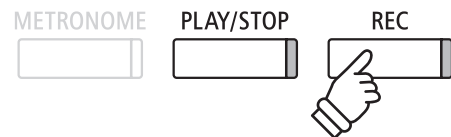

* It may be desirable to adjust the Balance and Tempo lesson function settings before starting the recording.

The LED indicators for the REC and PLAY/STOP buttons will turn on to indicate that recording mode is in use. A one bar count-in will be heard before the finger exercise starts to play and record.

2. Evaluating the recorded finger exercise

Press the PLAY/STOP button

The LED indicators for the REC and PLAY/STOP buttons will turn off, and the finger exercise recording and playback will stop.

The recorded practice will be evaluated for note accuracy, timing evenness, and volume consistency, with the results shown alternately in the LCD display.

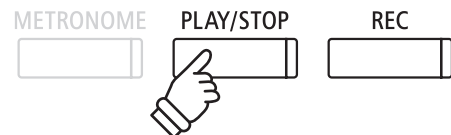

* Press the REC and PLAY/STOP buttons simultaneously to erase the recorded lesson song practice. The recorded practice will be erased automatically when a different lesson song is selected.

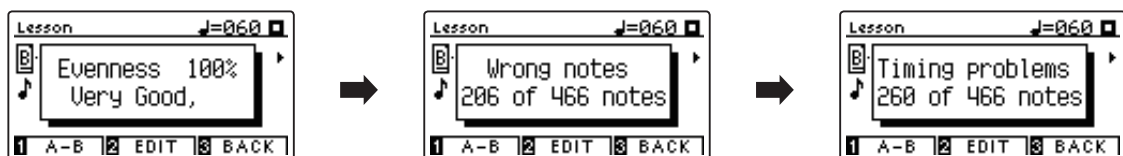

3. Playing back the recorded finger exercise

Press the PLAY/STOP button again.

The LED indicator for the PLAY/STOP button will turn on, and a one bar count-in will be heard before the recorded finger exercise starts to play.

Press the PLAY/STOP button once again.

The LED indicator for the PLAY/STOP button will turn off, and the recorded finger exercise song will stop playing.

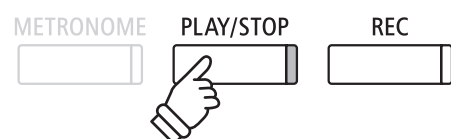

* Press ▼ or ▲ buttons to cycle through the evaluation results. The recorded finger exercise can be replayed even after cancelling the evaluation result screen.

Concert Magic

The Concert Magic function allows complete beginners to enjoy playing the piano by simply selecting one of the 176 pre-programmed songs, then tapping the keyboard with a steady rhythm and tempo.

For a complete listing of available Concert Magic songs, please refer to the separate 'Internal Song Lists' booklet.

1 Performing a Concert Magic song

The 176 Concert Magic songs are divided into banks 'A' and 'B', with each bank containing 88 songs.

1. Entering Concert Magic mode

Press the **[3]** FUNCTION button (MUSIC), then press the **▼** or **▲** buttons to select Concert Magic.

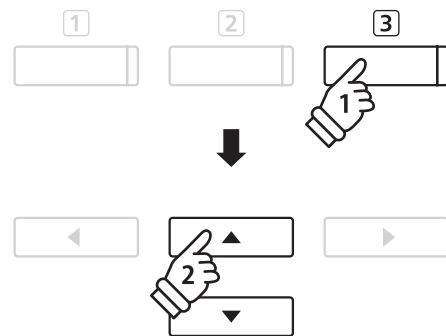
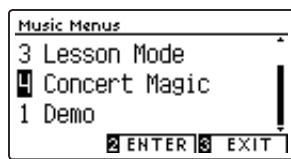

Press the **[2]** FUNCTION button (ENTER) to enter Concert Magic.

The bank, number, and name of the selected Concert Magic song will be shown in the LCD display.

2. Selecting a Concert Magic song

While Concert Magic mode is in use:

Press and hold the **[2]** FUNCTION button (EDIT), then press the key to which the Concert Magic song (bank 'A') is assigned.

A Concert Magic song from bank 'A' will be selected, with the song number and name shown in the LCD display.

* To select a song from bank 'B', press the same key again. Repeatedly pressing the same key will alternate between banks 'A' and 'B'.

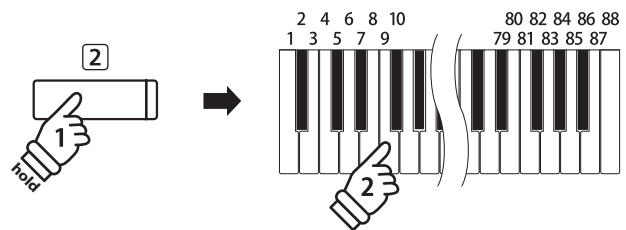

3. Performing the selected Concert Magic song

Press a key on the keyboard.

The song will advance with every key that is pressed. Pressing the keys gently will produce a soft sound, while pressing heavily will produce a loud sound.

As the song advances, the ● symbols shown in the LCD will be replaced by • symbols. This is called the Note Navigator.



4. Changing the Concert Magic playback sound

Press a SOUND button to change the sound used for the Concert Magic song (melody and accompaniment parts).

It is also possible to select independent sounds for the melody and accompaniment parts:

Press the **[1]** FUNCTION button (SPLIT), to enable Concert Magic split mode.

Press a SOUND button to change the melody sound.

Press and hold the **[1]** FUNCTION button (SPLIT), then press a SOUND button to change the accompaniment sound.

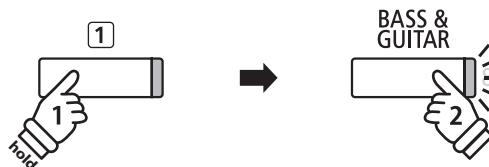
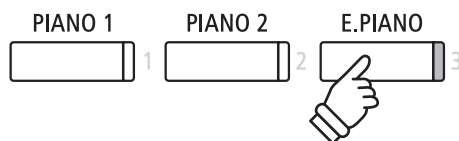

5. Exiting Concert Magic mode

Press the **[3]** FUNCTION button (BACK), to exit Concert Magic mode.

2 Concert Magic demo mode

This function allows all of the Concert Magic songs to be played back randomly or in designated categories.

■ Random playback

Enter Concert Magic mode and select the desired song.

Press the PLAY/STOP button.

All 176 Concert Magic songs will be played in a random order until the PLAY/STOP button is pressed again.



■ Category playback

Enter Concert Magic mode and select the desired song.

Press and hold the **[2]** FUNCTION button (EDIT), then press the PLAY/STOP button.

Songs in the same category as the selected song, will be played in sequential order until the PLAY/STOP button is pressed again.

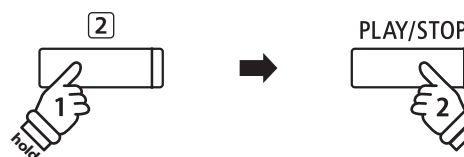

Example: If the song 'Row, Row, Row Your Boat' is selected, all other songs in the 'Children's Songs' category will be played.



3 Concert Magic settings

The Concert Magic settings menu allows the playback tempo, playing mode, and volume balance to be adjusted.

■ Concert Magic settings

Concert Magic setting	Description	Default setting
Tempo	Adjust the playback tempo of the Concert Magic song in beats per minute (BPM).	Song specific
Mode	Change the Concert Magic playing mode (see below).	Normal
Balance	Adjust the volume balance between the melody and accompaniment parts.	9 - 9

■ Entering the Concert Magic settings menu

While Concert Magic mode is in use:

Press the  FUNCTION button (EDIT).

The Concert Magic settings menu will be shown in the LCD display.

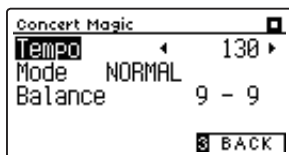
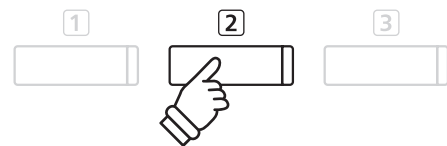

■ Adjusting Concert Magic settings

After entering the Concert Magic settings menu:

Press the ▼ or ▲ buttons to move the selection cursor over the desired setting.

Press the ◀ or ▶ buttons to adjust the selected setting.

* To reset the current setting to the default value, press the ◀ and ▶ buttons simultaneously.

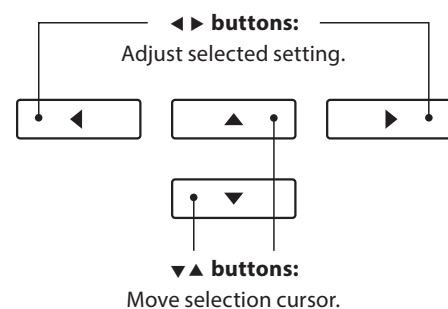

Steady Beat mode

Steady Beat mode allows all Concert Magic songs to be played by simply tapping any key with a constant steady beat, regardless of the song arrangement type.

4 Concert Magic song arrangement types

Concert Magic songs are divided into three different arrangement types, each requiring a different level of skill to be performed correctly.

* The Concert Magic arrangement type for each song is indicated in the 'Internal Song Lists' booklet as 'EB', 'MP', or 'SK'.

Easy Beat

EB

These are the easiest songs to play. To perform them, simply tap out a constant steady beat on any key on the keyboard.

The following example shows the notated score for 'Für Elise', indicating that a constant, steady rhythm should be maintained throughout the song. This is the distinguishing characteristic of an Easy Beat song.

Key on: X



The musical notation for 'Für Elise' is presented in 3/8 time. The treble clef staff shows a melody starting with a quarter rest, followed by a series of eighth and sixteenth notes. The bass clef staff shows a simple accompaniment pattern of eighth notes. Above the staff, a sequence of 'X' marks indicates a constant steady beat throughout the piece.

Melody Play

MP

These songs are also relatively easy to play, especially if they are familiar to the player. To perform them, tap out the rhythm of the melody on any key of the keyboard. Singing along as the rhythm is tapped can be helpful.

The following example shows the notated score for 'Twinkle, Twinkle, Little Star'.

* When performing fast Concert Magic songs, it may be easier to tap different keys with two alternating fingers in order to play at a greater speed.

Key on: X X X X X X X X X X X X X X X



The musical notation for 'Twinkle, Twinkle, Little Star' is presented in common time (C). The treble clef staff shows a simple melody of quarter notes. The bass clef staff shows a simple accompaniment pattern of chords. Above the staff, a sequence of 'X' marks indicates the rhythm of the melody.

Skillful

SK

These songs range in difficulty from moderately difficult to difficult. To perform them, tap out the rhythm of both the melody and the accompaniment notes on any key of the keyboard. The Note Navigator will be very helpful when playing the Skillful type songs.

The following example shows the notated score for 'Waltz of the Flowers'.

Key on X X X X X X X X X X X X X



The musical notation for 'Waltz of the Flowers' is presented in 3/4 time. The treble clef staff shows a melody with quarter and eighth notes. The bass clef staff shows a simple accompaniment pattern of chords. Above the staff, a sequence of 'X' marks indicates the rhythm of the melody.

Internal Recorder

The CN39 digital piano allows up to 10 different songs to be recorded, stored in internal memory, and played back at the touch of a button. Each song consists of two separate tracks – referred to as ‘parts’ – that can be recorded and played back independently. This allows the left-hand part of a song to be recorded first on one track, and the right-hand part to be recorded later on the other track.

1 Recording a song

1. Entering song recorder mode

Press the REC button.

The LED indicator for the REC button will start to flash, and the Internal Recorder record screen will appear with the currently selected song and part number shown in the LCD display.

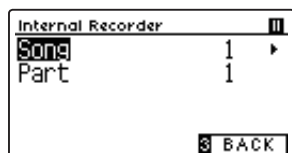

* If a USB memory device is connected, press the  FUNCTION button (INT) to select the internal song recorder.

2. Selecting the song/part to be recorded

Press the ▼ or ▲ buttons to move the selection cursor over the song memory or part.

Press the ◀ or ▶ buttons to change the selected song memory or part to be recorded.

If a part has already been recorded, a * symbol will be shown.

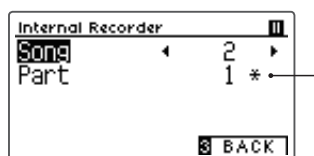
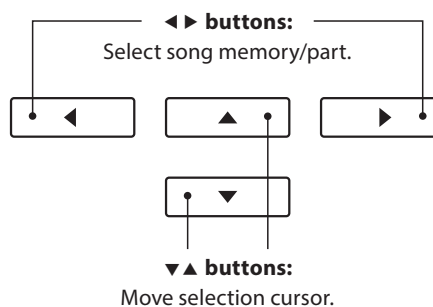

Part has been recorded



When recording part 1 and part 2 separately, select the song and part number carefully in order to prevent accidentally overwriting a previously recorded part.

3. Starting the song recorder

Press a key on the keyboard, or the PLAY/STOP button.

The LED indicators for the REC and PLAY/STOP buttons will turn on, and recording will start.

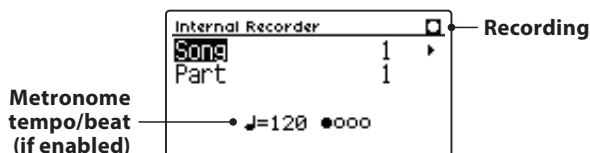
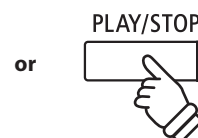
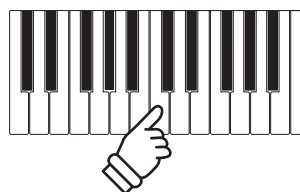

* Pressing the PLAY/STOP button allows a rest period or empty bar to be inserted at the beginning of the song.

* Press the METRONOME button before or during the recording to turn on the metronome. The metronome ‘click’ sound will not be recorded.

4. Stopping the song recorder

Press the PLAY/STOP button.

The LED indicators for the PLAY/STOP and REC buttons will turn off, the recorder will stop, and the part/song will be stored in internal memory.

After a few seconds, the Internal Recorder play screen will be shown in the LCD display, indicating that the song is ready for playback.

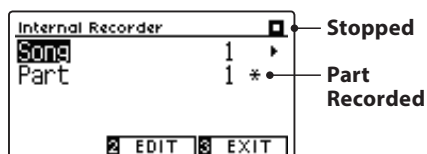

To play back the recorded song, please refer to the 'Playing a Song' instructions on page 52.

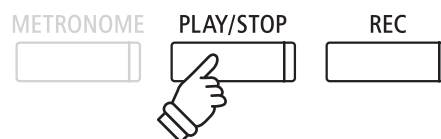

* The maximum recording capacity is approximately 90,000 notes, with button and pedal presses also counted as one note.

* If the maximum recording capacity is reached during recording, the recorder will stop automatically.

* Recorder songs will remain in memory after the power is turned off.

■ Recording a second part

To record a second part, repeat the above instructions, selecting the part that has not been recorded to.

■ Recording with the metronome

It is also possible to record songs with the metronome activated. This is useful when recording parts separately, or wishing to maintain correct timing throughout complex passages. Note that the standard metronome click will not be heard when the song is played back.

* For more information about the instrument's Metronome function, please refer to page 32.

■ Changing panel settings while recording

In some cases, it may be desirable to make changes to the selected sound or style while recording a song. The tables below list the various functions which will and will not be remembered during recording.

Panel operations remembered during recording

Changes made to the sound type. (SOUND buttons etc.)

Switching between dual/split modes.

Panel operations NOT remembered during recording*

Changes made to the reverb settings.

Changes made to the effects settings.

Changes made to the tempo.

Changes made to the volume balance in dual/split mode.

Changes made to transpose, tuning, touch, etc.

* Desired effects, reverb, and tempo settings etc. should be prepared before recording a new song.

5. Exiting song recorder mode

Press the **[EXIT]** FUNCTION button (EXIT), to exit the Internal Recorder and return to normal operation.



2 Playing a song

This function is used to playback recorder songs stored in internal memory. To playback a song/part immediately after recording, start this process from step 2.

1. Entering song play mode

Press the PLAY/STOP button.

The Internal Recorder play screen will be shown in the LCD display.

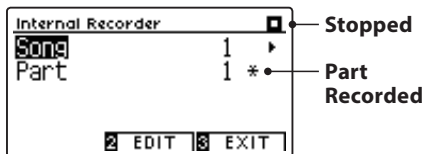

* If a USB memory device is connected, press the FUNCTION button (INT) to select the internal song recorder.

2. Selecting the song/part(s) to be played back

Press the ▼ or ▲ buttons to move the selection cursor over the song memory or part.

Press the ◀ or ▶ buttons to change the selected song memory (1-10) or part (1, 2, or 1&2) to be played back.

If a part has already been recorded, a * symbol will be shown.

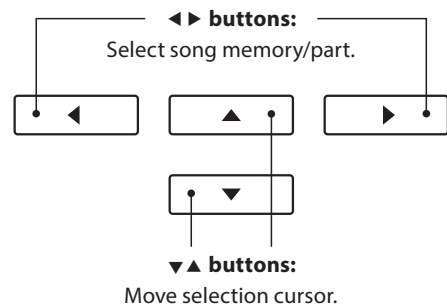
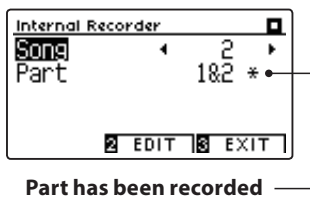

3. Starting/stopping song playback

Press the PLAY/STOP button.

The LED indicator for the PLAY/STOP buttons will turn on, and the selected song/parts will start to play.

- * The selected part can be changed during song playback.
- * To adjust the playback tempo of the recorded song, press and hold the METRONOME button, then press the ◀ or ▶ buttons.

Press the PLAY/STOP button again.

The LED indicator for the PLAY/STOP button will turn off and the song will stop playing.

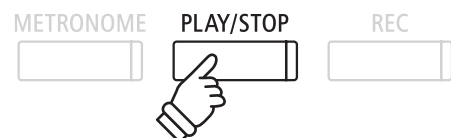
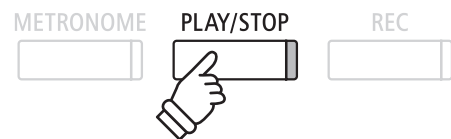

5. Exiting song play mode

Press the FUNCTION button (EXIT), to exit the Internal Recorder and return to normal operation.



3 Internal Recorder Edit menu

The Internal Recorder Edit menu features settings that allow the pitch of the keyboard or song to be adjusted in semi-tone steps. This menu also includes functions to delete the song, or convert the song to an audio file.

Internal Recorder menu

Internal Recorder function	Description	Default setting
Key Transpose	Raise or lower the pitch of the keyboard in semi-tone steps.	0 (C)
Song Transpose	Raise or lower the pitch of the recorder song in semi-tone steps.	0
Erase	Erase a part of a recorder song from memory (see page 54).	-
Convert to Audio	Convert a recorder song to an MP3/WAV audio file (see page 55).	-

Entering the Internal Recorder menu

While the Internal Recorder play screen is shown in the LCD display:

Press the **[2]** FUNCTION button (EDIT).

The Internal Recorder menu will be shown in the LCD display.

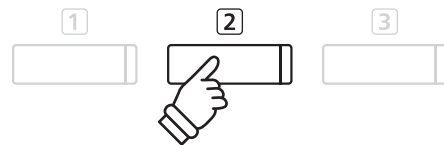

Adjusting the Internal Recorder settings/functions

After entering the Internal Recorder edit menu:

Press the **▼** or **▲** buttons to move the selection cursor over the desired setting.

Press the **◀** or **▶** buttons to adjust the selected setting.

* To reset the current setting to the default value, press the **◀** and **▶** buttons simultaneously.

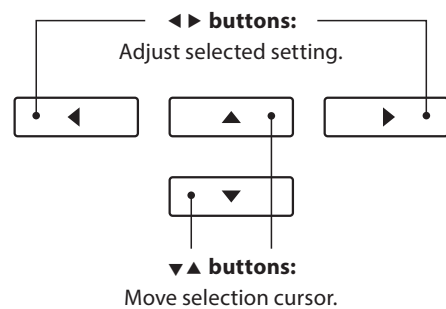

Exiting the Internal Recorder menu

Press the **[3]** FUNCTION button (BACK), to exit the Internal Recorder menu and return to normal operation.



4 Erasing a part/song

This function is used to erase recorder parts that may have been recorded incorrectly or songs that are no longer listened to. Once a part/song has been erased from memory it cannot be recovered.

1. Selecting the Erase function

After entering the Internal Recorder edit menu (see page 53):

Press the ▼ or ▲ buttons to move the selection cursor over the Erase function.



Press the 2) FUNCTION button (ENTER) to select the Erase function.

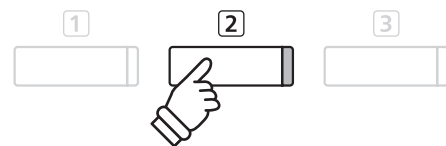
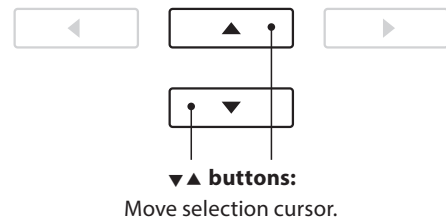

2. Selecting the song/part to be erased

Press the ▼ or ▲ buttons to move the selection cursor over the song memory or part.

Press the ◀ or ▶ buttons to change the selected song memory (1-10) or part (1, 2, or 1&2) to be erased.

If a part has already been recorded, a * symbol will be shown.

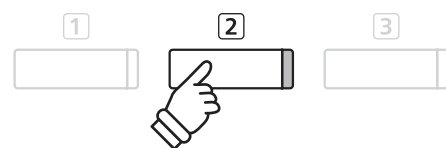
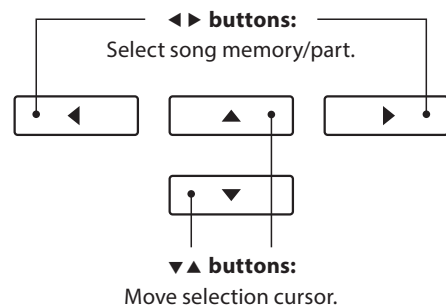

3. Erasing the selected song/part

Press the 2) FUNCTION button (OK) to Erase the selected song and part.

A confirmation message will be shown in the LCD display, prompting to confirm or cancel the erase operation.

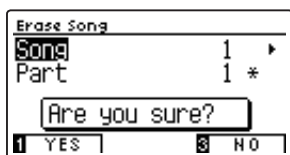

Press the 1) FUNCTION button (YES) to confirm the erase operation, or the 3) FUNCTION button (NO) to cancel.



Erasing all recorder songs from memory

Press and hold the PLAY/STOP and REC buttons, then turn the instrument's power off/on.

All recorder songs stored in memory will be erased.

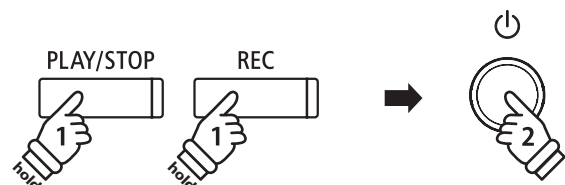

5 Converting a song to an audio file

This function allows recorder songs stored in internal memory to be played back and saved (converted) as an audio file to a USB device in either MP3 or WAV format.

1. Selecting the Convert to Audio function

After entering the Internal Recorder edit menu (see page 53):

Press the ▼ or ▲ buttons to move the selection cursor over the Convert to Audio function.



Press the [2] FUNCTION button (ENTER) to select the Convert to Audio function.

* If a USB memory device is not connected, a prompt will be shown.

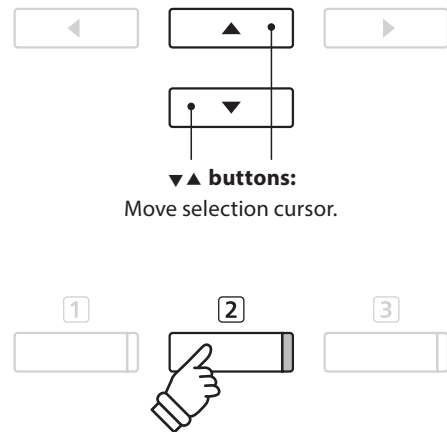

2. Selecting the song/part to be converted

Press the ▼ or ▲ buttons to move the selection cursor over the song memory or part.

Press the ◀ or ▶ buttons to change the selected song memory (1-10) or part (1, 2, or 1&2) to be converted.

If a part has already been recorded, a * symbol will be shown.

Press the [2] FUNCTION button (NEXT) to continue.

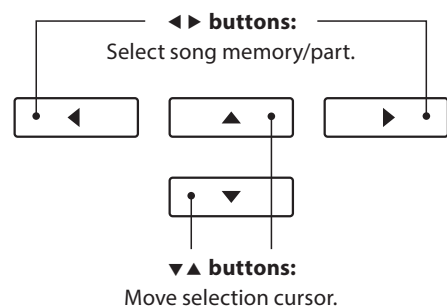

3. Selecting the audio file format

Press the ◀ or ▶ buttons to select the desired file format for the converted song.

It is also possible to adjust the recording gain at this stage.

* For more information about the instrument's audio recorder gain setting, please refer to page 56.

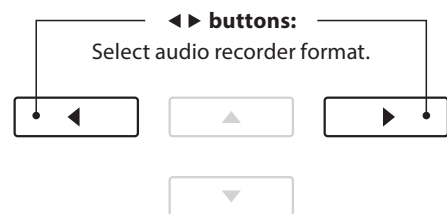

4. Starting the conversion

Press the PLAY/STOP button, or a key on the keyboard.

The LED indicator for the PLAY/STOP and REC buttons will turn on, the selected song will play, and the convert to audio process will start.

* Notes played on the keyboard will also be recorded to the audio file.

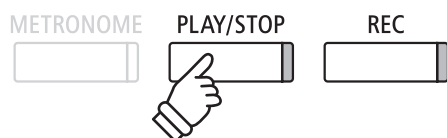

■ Naming and saving the converted audio file

Please follow the 'Recording an MP3/WAV audio file' instructions on pages 56~57. from step 4.

1 Recording an MP3/WAV audio file

The CN39 digital piano is also capable of recording performances as digital audio – saving the data to a USB memory device in either MP3 or WAV format. This useful function allows professional quality recordings to be produced directly on the instrument – without the need for additional sound equipment – then emailed to friends and family, listened to away from the instrument, or edited and remixed further using an audio workstation.

■ Audio Recorder format specifications

Audio format	Specifications	Bitrate
MP3	44.1 kHz, 16 bit, Stereo	256 kbit/s (fixed)
WAV	44.1 kHz, 16 bit, Stereo	1,411 kbit/s (uncompressed)

MPEG Layer-3 audio coding technology licensed from Fraunhofer IIS and Thomson.
MP3 codec is Copyright (c) 1995-2007, SPIRIT.

1. Entering USB recorder mode

Connect a USB memory device to the USB port.

Press the REC button.

The LED indicator for the REC button will start to flash, and the USB Recorder format screen will be shown in the LCD display.



2. Selecting the USB recorder file format

Press the ◀ or ▶ buttons to select the desired USB recorder audio file format (WAV or MP3).

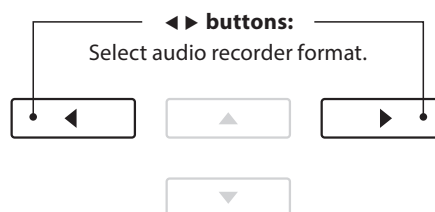

* MP3 audio files require less storage space than WAV audio files.

* A 1 GB USB memory device can store over 12 hours of MP3 audio data.

■ Adjusting the recording volume (Gain)

Press the [2] FUNCTION button (GAIN).

The gain adjustment screen and recording level meter will be shown in the LCD display.

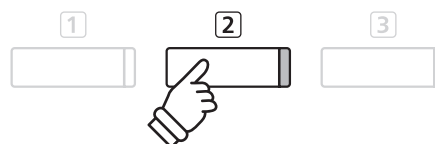
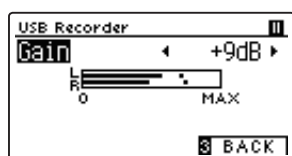

Press the ◀ or ▶ buttons to adjust the recorder gain setting.

* To reset the gain setting to the default level, press the ◀ and ▶ buttons simultaneously.

* The gain setting can be adjusted within the range of 0 dB~+15 dB.

* Exercise caution when increasing the gain setting, as higher levels may result in distorted recordings.

3. Starting the USB recorder

Press a key on the keyboard, or the PLAY/STOP button.

The LED indicators for the REC and PLAY/STOP buttons will turn on, and recording will start.

The current recording time will also be shown in the LCD display.

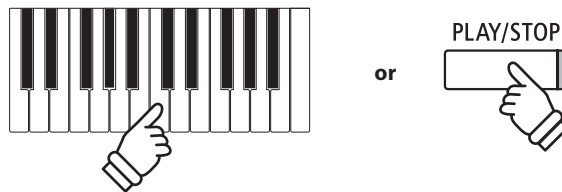
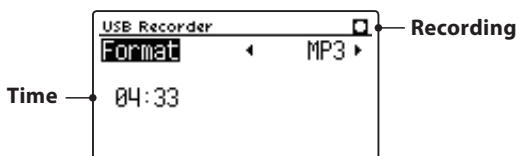

- * Pressing the PLAY/STOP button allows a rest period or empty bar to be inserted at the beginning of the song.
- * Press the METRONOME button before or during the recording to turn on the metronome. The metronome 'click' sound will not be recorded, however drum patterns will be recorded.

4. Stopping the USB recorder, saving the file

Press the PLAY/STOP button.

The LED indicators for the PLAY/STOP and REC buttons will turn off, and recording will stop.

A confirmation message will be shown in the LCD display, prompting to confirm or cancel the save operation.

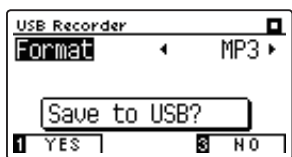

Press the ① FUNCTION button (YES) to confirm the save operation, or the ③ FUNCTION button (NO) to cancel.



5. Naming the recorded audio file, confirming save

After confirming the save operation:

Press the ▼ or ▲ buttons to cycle through the alphanumeric characters, and the ◀ or ▶ buttons to move the cursor.



Press the ② FUNCTION button (OK) to confirm the save operation, or the ③ FUNCTION button (BACK) to cancel.

The recorded audio file will be saved with the specified name.

After a few seconds, the USB Recorder play screen will be shown in the LCD display, indicating that the audio is ready for playback.

To play back the recorded audio file, please refer to the 'Playing an MP3/WAV audio file' instructions on page 58.

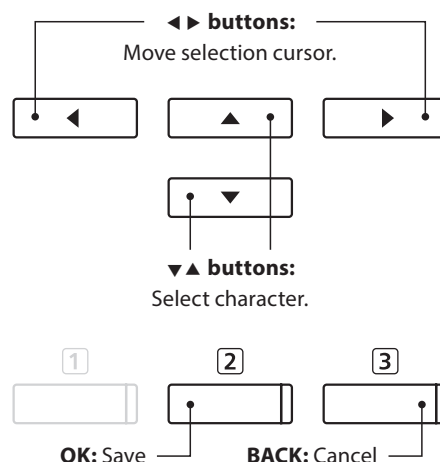

- * 'Audio-000' will be used as the default name for the recorded audio files, with the number increasing automatically.
- * The recorded audio file will be saved in the root folder of the USB memory device. It is not possible to save the file in a different folder.

2 Playing an MP3/WAV audio file

The CN39 digital piano is also capable of playing MP3 and WAV audio files stored on a USB memory device directly through the instrument's speaker system. This function is particularly useful when attempting to learn the chords or melody to a new piece, or to simply play along with one's favorite song.

■ Audio Player supported format specifications

Audio format	Specifications	Bitrate
MP3	32 kHz/44.1 kHz/48 kHz, Mono/Stereo	8-320 kbit/s (fixed & variable)
WAV	32 kHz/44.1 kHz/48 kHz, Mono/Stereo, 16 bit	-

MPEG Layer-3 audio coding technology licensed from Fraunhofer IIS and Thomson.
MP3 codec is Copyright (c) 1995-2007, SPIRIT.

■ Preparing the USB memory device

First, prepare a selection of MP3 or WAV audio files, copying the data to a USB memory device.

* USB devices should be formatted to use the 'FAT' or 'FAT32' filesystems. Please refer to page 136 for more information.



1. Entering USB playback mode

Connect a USB memory device to the USB port.

Press the PLAY/STOP button.

The LED indicator for the the PLAY/STOP button will turn on, and the Song Browser screen will be shown in the LCD display.

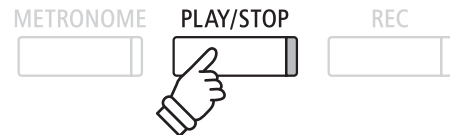

■ Song Browser screen

The Song Browser screen provides a listing of relevant files and folders stored on the connected USB device.

The 🎵 icon is used to represent an MP3/WAV audio file.

The 📁 icon is used to represent a folder.

The 📁 icon is used to represent the current/previous folder.

An example of a typical file/folder listing screen is shown below. Please note that the visible screen height has been extended for the purpose of this illustration.

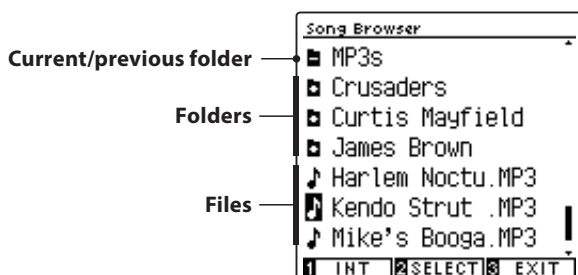
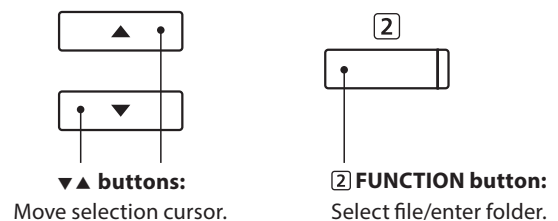

* Files and folders will be listed in alphabetical order, with folders shown at the top of the screen.

* When the USB Recorder play function is selected, only MP3, WAV, MID, and KSO files will be shown in the Song Browser screen.

* The LCD display is capable of showing filenames with a maximum length of 12 characters (+3 character suffix). Filenames longer than 12 characters will be truncated automatically.

2. Selecting an audio file

Press the ▼ or ▲ buttons to move the selection cursor, then press the **[2]** FUNCTION button (SELECT) to select the audio file.

The USB Recorder play screen will be shown in the LCD display.

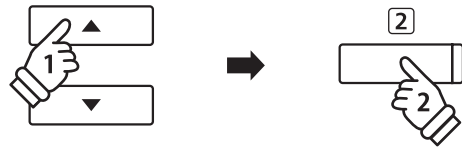

3. Playing the selected audio file

Press the PLAY/STOP button.

The selected audio file will start to play, and information about the file will be shown in the LCD display.

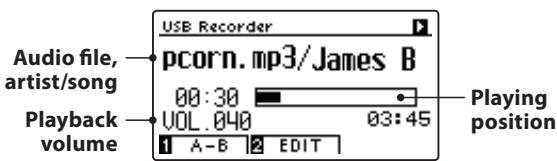
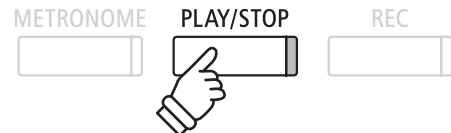

* If the selected audio file contains embedded metadata (e.g. ID3 tags) such as artist name and song title, this information will be also shown beside the filename.

■ Controlling audio file playback

While the audio file is playing:

Press the PLAY/STOP button to pause and resume playback.

Press the ◀ or ▶ buttons to rewind or advance the playing position of the audio file.

Press the ▼ or ▲ buttons to adjust the playback volume of the audio file.

* The playback volume can be adjusted within the range of 1~100.

Press the **[1]** FUNCTION button (A-B) twice to set the start and end points of the A-B loop.

* Pressing the A-B button for a third time will turn off the loop.

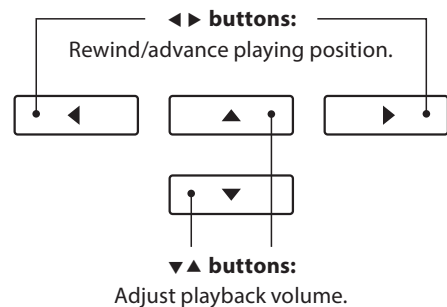

* There may be a noticeable difference in volume between audio file playback and the CN39 keyboard sound. When playing back audio data, please adjust the volume of the audio file as desired.

■ USB Recorder Edit menu

The USB Recorder Edit menu allows the playback mode (Single, 1-Repeat, All-Repeat, Random) to be changed, and the pitch of the keyboard to be transposed in semi-tone steps. Please refer to page 64 for more information.

■ Overdub function

The Overdub function allows the sound of the CN39 to be recorded (overdubbed) to an existing MP3 or WAV audio file. Please refer to page 66 for more information.

4. Exiting USB playback mode

Press the **[3]** FUNCTION button (BACK) to exit USB playback mode and return to normal operation.



3 Recording a MIDI song file

In addition to MP3 and WAV audio files, the CN39 digital piano is also capable of recording 16 track SMF (Standard MIDI File) format songs directly to a USB memory device. This useful function allows multi-track performances to be created one part at a time, without the need for additional recording devices.

■ MIDI Song Recorder format specifications

Song format	Specifications
MID	Format 0

1. Entering USB recorder mode

Connect a USB memory device to the USB port.

Press the REC button.

The LED indicator for the REC button will start to flash, and the USB Recorder format screen will be shown in the LCD display.



* It is also possible to re-record/edit to an existing MIDI song stored on a USB memory device. Please refer to the 'Recording to an existing MIDI song file' instructions on page 67.

2. Selecting the MIDI song file format

Press the ◀ or ▶ buttons to select the MIDI song format.

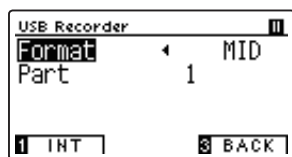

An additional 'Part' setting will be shown in the LCD display.

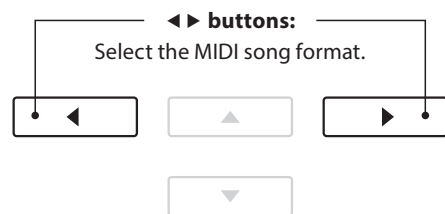

3. Selecting the part (track) to be recorded

Press the ▼ button to select the 'Part' setting, then press the ◀ or ▶ buttons to select the part (track) to be recorded.

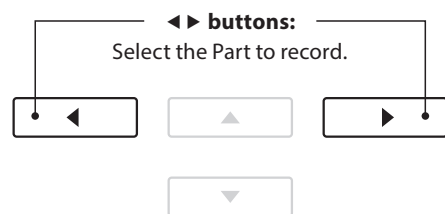
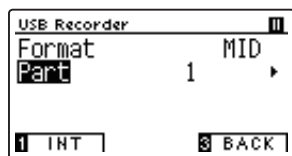

*The Part setting can be set to 1~16 or MIDI.

* An asterisk (*) symbol will be shown beside the part number to indicate that the part has been recording and contains song data.

* Unlike the internal song recorder, MIDI songs do not allow the sound of a part to be changed during recording. It is therefore necessary to select the desired sound before recording each part.

* Part 10 is reserved as a drum track. When Part 10 is selected, a drum set sound will be selected automatically.

* When the Part is set to MIDI, all data received from the MIDI IN or USB MIDI connectors will be recorded on Parts 1~16, according to the MIDI channel.

4. Starting the USB recorder

Press a key on the keyboard, or the PLAY/STOP button.

The LED indicators for the REC and PLAY/STOP buttons will turn on, and recording will start.

The current recording time will also be shown in the LCD display.

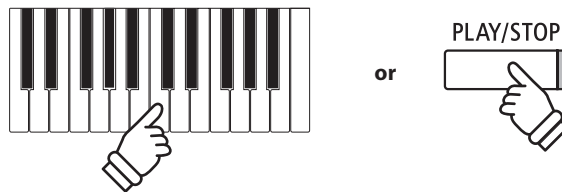
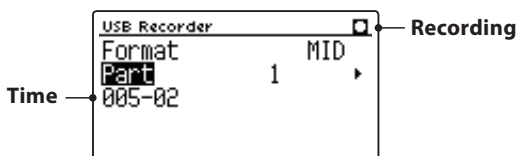

* Pressing the PLAY/STOP button allows a rest period or empty bar to be inserted at the beginning of the song.

* Press the METRONOME button before or during the recording to turn on the metronome. The metronome 'click' sound and drum patterns will not be recorded to the MIDI song.

5. Stopping the USB recorder, saving the file

Press the PLAY/STOP button.

The LED indicators for the PLAY/STOP and REC buttons will turn off, and recording will stop.

A confirmation message will be shown in the LCD display, prompting to confirm or cancel the save operation.

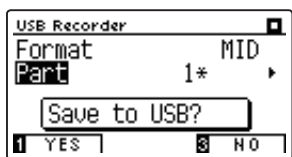

Press the ① FUNCTION button (YES) to confirm the save operation, or the ③ FUNCTION button (NO) to cancel.

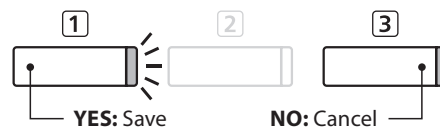

6. Naming the recorded MIDI song file, confirming save

After confirming the save operation:

Press the ▼ or ▲ buttons to cycle through the alphanumeric characters, and the ◀ or ▶ buttons to move the cursor.

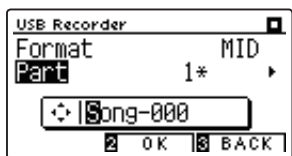

Press the ② FUNCTION button (OK) to confirm the save operation, or the ③ FUNCTION button (BACK) to cancel.

The recorded MIDI song file will be saved with the specified name.

To play back the recorded MIDI song file, please refer to the 'Playing a MIDI song file' instructions on page 62.

To continue recording additional parts (tracks) to the MIDI song file, please refer to the 'Recording to an existing MIDI song file' instructions on page 67.

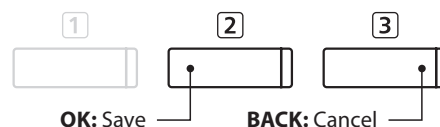
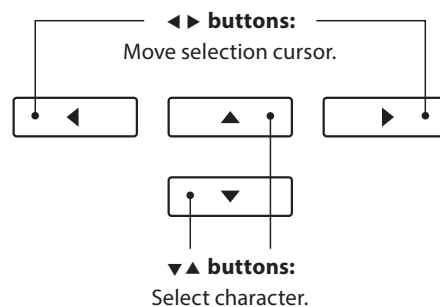

* 'Song-000' will be used as the default name for the recorded MIDI song file, with the number increasing automatically.

* The recorded MIDI song file will be saved in the root folder of the USB memory device. It is not possible to save the file in a different folder.

4 Playing a MIDI song file

The CN39 digital piano also supports the playback of Standard MIDI File (SMF) files and CN39 recorder songs stored on a USB memory device, allowing a vast selection of widely accessible music to be heard through the instrument's exquisite Progressive Harmonic Imaging sound engine.

■ Song Player supported format specifications

Song format	Specifications
MID	Format 0, Format 1
KSO	Kawai Song file

■ Preparing the USB memory device

First, prepare a selection of MIDI (SMF) song files, copying the data to a USB memory device.

* USB devices should be formatted to use the 'FAT' or 'FAT32' filesystems. Please refer to page 136 for more information.



1. Entering USB playback mode

Connect a USB memory device to the USB port.

Press the PLAY/STOP button.

The LED indicator for the the PLAY/STOP button will turn on, and the Song Browser screen will be shown in the LCD display.

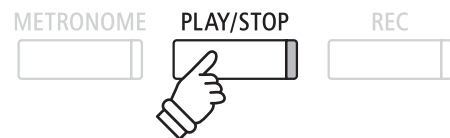

■ Song Browser screen

The Song Browser screen provides a listing of relevant files and folders stored on the connected USB device.

The 🎵 icon is used to represent a MIDI song file.

The 📁 icon is used to represent a folder.

The 📁 icon is used to represent the current/previous folder.

An example of a typical file/folder listing screen is shown below. Please note that the visible screen height has been extended for the purpose of this illustration.

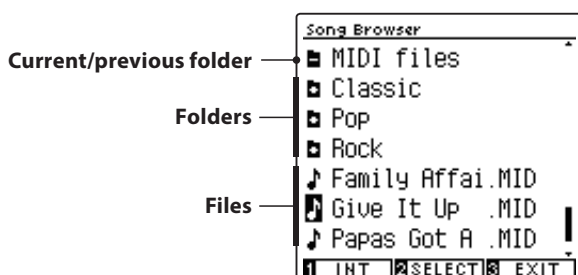
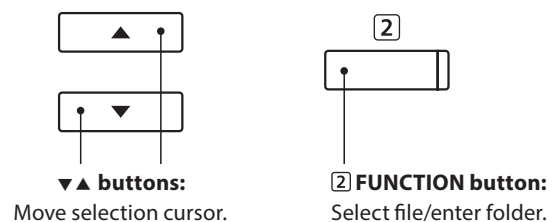

* Files and folders will be listed in alphabetical order, with folders shown at the top of the screen.

* When the USB Recorder play function is selected, MP3, WAV, MID, and KSO files will be shown in the Song Browser screen.

* The LCD display is capable of showing filenames with a maximum length of 12 characters (+3 character suffix). Filenames longer than 12 characters will be truncated automatically.

2. Selecting a MIDI file

Press the ▼ or ▲ buttons to move the selection cursor, then press the [2] FUNCTION button (SELECT) to select the MIDI file.

The USB Recorder play screen will be shown in the LCD display.

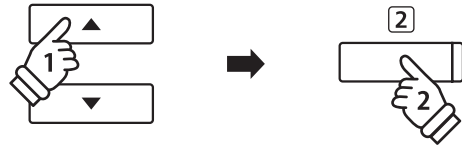

3. Playing the selected MIDI file

Press the PLAY/STOP button.

The selected MIDI file will start to play, and information about the file will be shown in the LCD display.

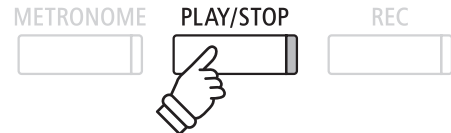

■ Controlling MIDI file playback

While the MIDI file is playing:

Press the PLAY/STOP button to pause and resume playback.

Press the ◀ or ▶ buttons to rewind or advance the playing position of the MIDI file.

Press the ▼ or ▲ buttons to adjust the playback volume of the MIDI file.

* The playback volume can be adjusted within the range of 1~100

Press the [1] FUNCTION button (A-B) twice to set the start and end points of the A-B loop.

* Pressing the A-B button for a third time will turn off the loop.

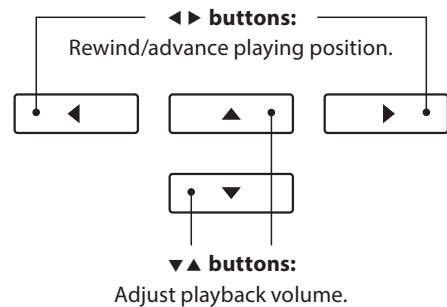

■ USB Recorder Edit menu

The USB Recorder Edit menu allows the playback mode to be changed, the tempo and part playback of the MIDI song to be adjusted, and the pitch of the keyboard or song to be transposed in semi-tone steps. Please refer to page 64 for more information.

■ Convert MIDI to Audio function

The Convert MIDI to Audio function allows MIDI files or CN39 recorder songs stored on a USB memory device to be converted to MP3/WAV audio files. Please refer to page 65 for more information.

■ Exiting USB playback mode

Press the [3] FUNCTION button (BACK) to exit USB playback mode and return to normal operation.



5 USB Recorder Edit menu

The USB Recorder Edit menu allows the playback mode of the audio/MIDI file to be changed to one of four types. This menu also features settings to adjust the MIDI song playback tempo, to transpose the pitch of the keyboard or MIDI song in semi-tone steps, and to control the part playback of a MIDI song.

■ USB Recorder menu

USB Recorder function	Description	Default setting
Play Mode	Change the audio/MIDI file playback mode (see below).	Single
Tempo	Adjust the playback tempo of the MIDI song in beats per minute (BPM).	–
Key Transpose	Raise or lower the pitch of the keyboard in semi-tone steps.	0 (C)
Song Transpose	Raise or lower the pitch of the recorder/MIDI song in semi-tone steps.	0
Song Part	Play/mute the 16 individual parts (tracks) of a MIDI song.	Play all parts

* Tempo, Song Transpose, and Song Part settings will not be shown when an audio file is selected.

■ Play Mode settings

Play Mode setting	Description
Single	The selected audio/MIDI file will be played once.
1-Repeat	The selected audio/MIDI file will be repeated.
All-Repeat	All audio/MIDI files in the current folder will be played repeatedly.
Random	All audio/MIDI files in the current folder will be played in random order.

■ Entering the USB Recorder menu

While the USB Recorder screen is shown in the LCD display:

Press the **[2]** FUNCTION button (EDIT).

The USB Recorder menu will be shown in the LCD display.

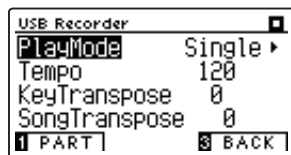

■ Adjusting the USB Recorder settings

After entering the USB Recorder menu:

Press the **▼** or **▲** buttons to move the selection cursor over the desired setting.

Press the **◀** or **▶** buttons to adjust the selected setting.

* To reset the current setting to the default value, press the **◀** and **▶** buttons simultaneously.

■ Adjusting the Song Part setting

After entering the USB Recorder menu:

Press the **[1]** FUNCTION button (PART) to enter the part select screen.

* The PART button will only be shown when a MIDI song file is loaded.

Press the **▼** or **▲** buttons to move the selection cursor over the desired part.

Press the **◀** or **▶** buttons to change the part setting.

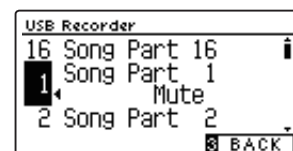

6 Converting a MIDI song file to an MP3/WAV audio file

This function allows MIDI files or CN39 recorder songs stored on a USB memory device to be played back and saved (converted) as an audio file (to the USB device) in either MP3 or WAV format.

1. Selecting the MIDI song to be converted

While the Song Browser Player screen is shown in the LCD display:

Press the ▼ or ▲ buttons to move the selection cursor over the desired MIDI file, then press the REC button.



The LED indicator for the REC button will start to flash, and the Convert MIDI to Audio screen will be shown in the LCD display.

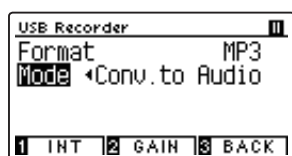

2. Selecting the audio file format

With the Format setting selected, press the ◀ or ▶ buttons to select the desired USB recorder audio file format (WAV or MP3).

It is also possible to adjust the recording gain at this stage.

* For more information about the instrument's audio recorder gain setting, please refer to page 56.

* It is also possible to record a new song directly to the USB device (i.e. not convert the previously selected song to an audio file) by changing the Mode setting to 'New Song'.

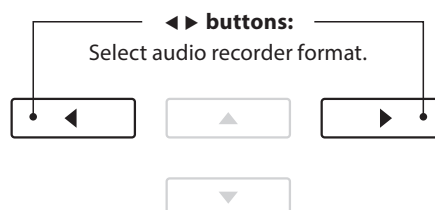

3. Starting the conversion

Press the PLAY/STOP button, or a key on the keyboard.

The LED indicator for the PLAY/STOP and REC buttons will turn on, the selected song will play, and the convert to audio process will start.

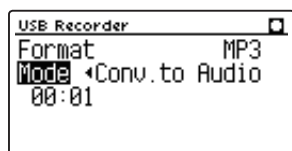

* Notes played on the keyboard will also be recorded to the audio file.

When the end of the song is reached, the save confirmation screen will be shown in the LCD display.

■ Naming and saving the converted audio file

Please follow the 'Recording an MP3/WAV audio file' instructions on pages 56~57. from step 4.

7 Overdubbing an MP3/WAV audio file

This function allows the sound of the CN39 to be recorded (overdubbed) to an existing MP3 or WAV audio file stored on a USB memory device.

* This function records/overdubs to a copy of the selected file – the original audio file will not be modified.

1. Selecting the audio file to be overdubbed

While the Song Browser Player screen is shown in the LCD display:

Press the ▼ or ▲ buttons to move the selection cursor over the desired MP3/WAV file, then press the REC button.

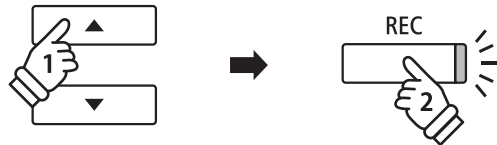

The LED indicator for the REC button will start to flash, and the Overdubbing screen will be shown in the LCD display.

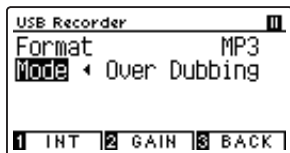

2. Selecting the audio file format

With the Format setting selected, press the ◀ or ▶ buttons to select the desired USB recorder audio file format (WAV or MP3).

* It is also possible to record a new audio file directly to the USB device (i.e. not overdub the previously selected audio file) by changing the Mode setting to 'New Song'.

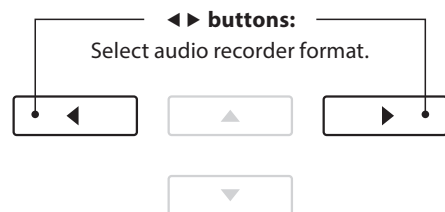

3. Starting the recording/overdubbing

Press the PLAY/STOP button, or a key on the keyboard.

The LED indicator for the PLAY/STOP and REC buttons will turn on, the selected audio file will play, and the recording/overdubbing process will start.

Notes played on the keyboard will be recorded to the audio file.

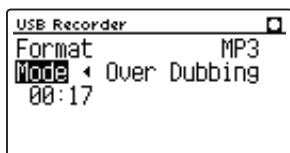

* The playback volume of the selected audio file will automatically be set to 100, in order to prevent a distorted recording.

When the PLAY/STOP button is pressed, the save confirmation screen will be shown in the LCD display.

■ Naming and saving the overdubbed audio file

Please follow the 'Recording an MP3/WAV audio file' instructions on pages 56~57. from step 4.

8 Recording to an existing MIDI song file

This function allows the parts (tracks) of a MIDI song file to be re-recorded, or for new parts to be added.

1. Selecting the MIDI song file to be re-recorded/added to

While the Song Browser Player screen is shown in the LCD display:

Press the ▼ or ▲ buttons to move the selection cursor over the desired MIDI file, then press the REC button.



The LED indicator for the REC button will start to flash, and the '16 Track Record' mode will be selected automatically.

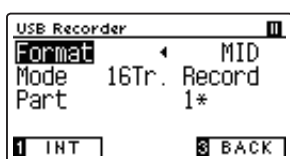

* It is also possible to record a new MIDI song file to the USB device (i.e. not re-record the selected song file) by changing the Mode to 'New Song'.

An additional 'Part' setting will be shown in the LCD display.

2. Selecting the part (track) to be recorded

Press the ▼ button to select the 'Part' setting, then press the ◀ or ▶ buttons to select the part (track) to be recorded.

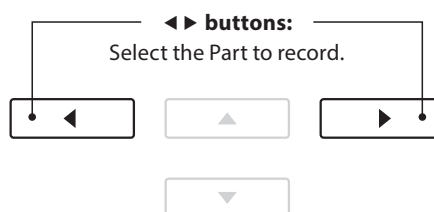
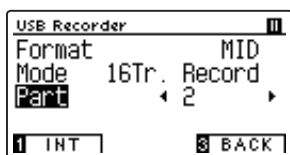

* An asterisk (*) symbol will be shown beside the part number to indicate that the part has been recording and contains song data.

* Please refer to page 60 for information regarding the restrictions that apply when recording to MIDI song files.

3. Starting the recording

Press the PLAY/STOP button, or a key on the keyboard.

The LED indicator for the PLAY/STOP and REC buttons will turn on, the selected MIDI song file will play, and the recording process will start.

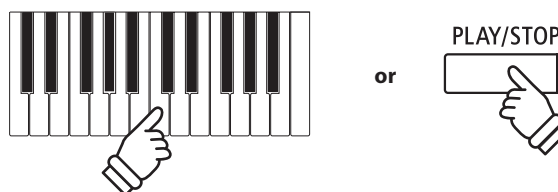

Notes played on the keyboard will be recorded to the selected MIDI song file and part.

When the PLAY/STOP button is pressed, the save confirmation screen will be shown in the LCD display.

■ Naming and saving the recorded MIDI song file

Please follow the 'Recording a MIDI song file' instructions on page 60~61 from step 5.

Function menus

The Function menus contain a variety of options to adjust the CN39 digital piano's operation and sound. Settings are grouped by category, providing convenient access to relevant controls. Once adjusted, settings can be stored to one of the instrument's 16 registration memories, or selected as the default power-on settings with the Startup Setting function.

* For more information about the Startup Setting function, please refer to page 79.

■ Entering the Function menus

While the normal playing mode screen is shown in the LCD display:

Press the **2** FUNCTION button (MENU).

The Function menu will be shown in the LCD display.

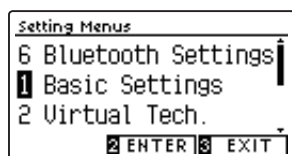

Press the **▼** or **▲** buttons to cycle through the different menus. Press the **2** FUNCTION button (ENTER) to enter the selected Function menu.

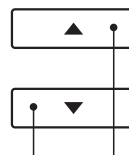
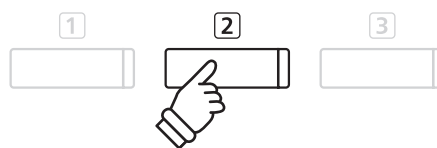

▼▲ buttons:
Move selection cursor.

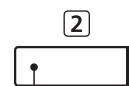

2 FUNCTION button:
Select function.

■ Exiting the Function menus

Press the **3** FUNCTION button (EXIT) to exit the Function menus and return to normal operation.



■ Overview of Function menus

1. Basic Settings

Key Transpose, Song Transpose, Tone Control, Speaker Volume, Tuning, Damper Hold, Split, Four Hands, Startup Setting, Factory Reset, Auto Display Off, Auto Power Off

2. Virtual Technician Settings

Touch Curve, Voicing, Damper Resonance, Damper Noise, String Resonance, Undamped String Resonance, Cabinet Resonance, Key-off Effect, Fallback Noise, Hammer Delay, Topboard Simulation, Decay Time, Minimum Touch, Stretch Tuning, Temperament, Temperament Key, Key Volume, Half-Pedal Adjust, Soft Pedal Depth

3. Phones Settings

SHS Mode, Phones Type, Phones Volume

4. MIDI Settings *

MIDI Channel, Send Program Change No., Local Control, Transmit Program Change No., Multi-timbral Mode, Channel Mute

5. USB Functions

Load Song, Load Registration All, Load Registration Single, Load Startup Setting, Save Internal Song, Save SMF Song, Save Registration All, Save Registration Single, Save Startup Setting, Rename File, Delete File, Format USB

6. Bluetooth Settings

Bluetooth Audio, Bluetooth Audio Volume, Bluetooth MIDI

* For information regarding MIDI functions and settings, please download the supplementary PDF manual from the Kawai Japan website: <http://www.kawai-global.com/support/manual/>

Basic Settings

The Basic Settings menu contains settings to adjust the pitch, tuning, and general sound of the instrument. This menu also allows favourite panel settings to be stored, or reset back to the original factory configuration.

Basic Settings

No.	Setting	Description	Default setting
1	Key Transpose	Raise or lower the pitch of the keyboard in semi-tone steps.	0 (C)
2	Song Transpose	Raise or lower the pitch of the recorder/MIDI song in semi-tone steps.	0
3	Tone Control	Change the EQ settings of the instrument's sound.	Off
4	Speaker Volume	Change the maximum volume level of the speaker output.	Normal
5	Tuning	Raise or lower the pitch of the instrument in 0.5 Hz steps.	440.0 Hz
6	Damper Hold	Change the effect of pressing the sustain pedal on organ, string, etc. sounds.	Off
7	Split	Enable the 'Split Mode' function.	Off
8	Four Hands	Enable the 'Four Hands Mode' function.	Off
9	Startup Setting	Store current panel settings as the default (power-on) configuration.	-
10	Factory Reset	Restore all panel settings to the original factory configuration.	-
11	Auto Display Off	Enable/disable the instrument's Auto Display Off function.	5 min.
12	Auto Power Off	Enable/disable the instrument's Auto Power Off energy saving function.	-

* Default settings will be shown in the first LCD display illustration (i.e. Step 1) for each setting explanation below.

Entering the Basic Settings menu

While the normal playing mode screen is shown in the LCD display:

Press the **[2]** FUNCTION button (MENU).

The Function menus will be shown in the LCD display.

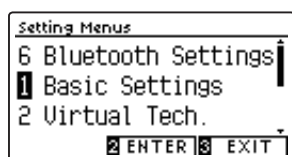

Press the **[2]** FUNCTION button (ENTER) again to enter the Basic Settings menu.

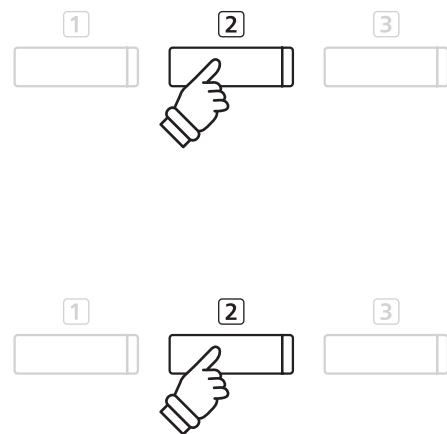

Selecting and adjusting the desired setting

After entering the Basic Settings menu:

Press the **▼** or **▲** buttons to move the selection cursor over the desired setting.

Press the **◀** or **▶** buttons to adjust the selected setting.

* To reset the current setting to the default value, press the **◀** and **▶** buttons simultaneously.

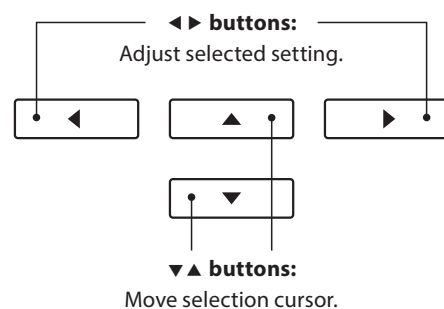

1 Key Transpose

The Key Transpose setting allows the pitch of the CN39 digital piano keyboard to be raised or lowered in semi-tone steps. This is particularly useful when accompanying instruments tuned for different keys, or when a song learned in one key must be played in another key. When transposed, the song can be played in the original key, yet heard in a different key.

1. Selecting the Key Transpose setting

After entering the Basic Settings menu (page 69):

Press the ▼ or ▲ buttons to select the Key Transpose setting.

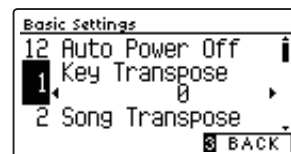

2. Adjusting the Key Transpose value

Press the ◀ or ▶ buttons to increase or decrease the value of the Key Transpose setting.

- * The keyboard pitch can be raised or lowered by up to 12 semi-tones.
- * To reset the Key Transpose setting to the default value, press the ◀ and ▶ buttons simultaneously.
- * Any changes made to the Key Transpose setting will remain until the power is turned off.
- * Preferred Key Transpose settings can be stored to a Registration Memory for convenient recall, or to the Startup Setting memory for automatic selection when the instrument is turned on. Please refer to pages 35 and 79 for more information.

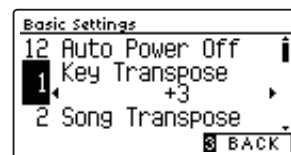
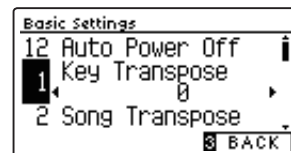

■ Current Transpose state

If the Key Transpose setting is set to a value other than 0 (C), the transpose icon and transpose value will appear at the top of the display.

Transpose enabled

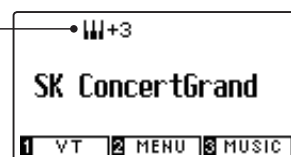

3. Exiting the Key Transpose setting

Press the [BACK] FUNCTION button (BACK) to exit the Key Transpose setting and return to the Function Menus screen.

2 Song Transpose

The Song Transpose setting allows the pitch of MIDI files or CN39 recorder songs stored on a USB memory device to be raised or lowered in semi-tone steps when played back.

1. Selecting the Song Transpose setting

After entering the Basic Settings menu (page 69):

Press the ▼ or ▲ buttons to select the Song Transpose setting.

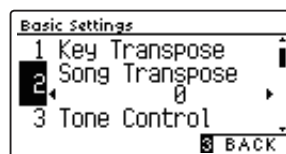

2. Adjusting the Song Transpose value

Press the ◀ or ▶ buttons to increase or decrease the value of the Song Transpose setting.

- * The song pitch can be raised or lowered by up to 12 semi-tones.
- * To reset the Song Transpose setting to the default value, press the ◀ and ▶ buttons simultaneously.
- * Any changes made to the Song Transpose setting will remain until the power is turned off.
- * Song Transpose settings cannot be stored to Registration or Startup Setting memory.

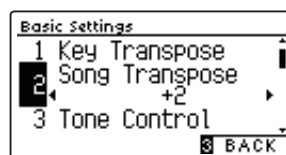
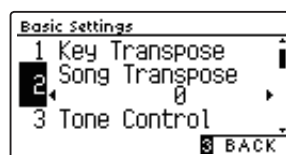

3. Exiting the Song Transpose setting

Press the [FUNCTION] button (BACK) to exit the Song Transpose setting and return to the Function Menus screen.

3 Tone Control

The Tone Control setting allows the overall sound character of the CN39 digital piano to be adjusted to provide the best sound quality within the area that the instrument is located. There are eight different preset EQ settings available, with an additional 'User' setting allowing finer control over the different frequency bands.

■ Tone Control setting

Tone Control type	Description
Flat (default)	Tone control adjustment is not applied.
Brilliance	Adjusts the overall brightness of the sound, independently of the Virtual Technician 'Voicing' parameter.
Bass Boost	Emphasises low-range frequencies, creating a deeper sound.
Bass Cut	Reduces low-range frequencies, creating a clearer sound.
Mid Boost	Emphasises mid-range frequencies, creating a harder sound.
Loudness	Emphasises frequencies to retain the instrument's sound character when playing at low volume levels.
Bright	Emphasises high-range frequencies, creating a brighter sound.
Mellow	Reduces high-range frequencies, creating a softer sound.
User	Allows the low, mid, and high-range frequency bands to be adjusted separately.

1. Selecting the Tone Control setting

After entering the Basic Settings menu (page 69):

Press the ▼ or ▲ buttons to select the Tone Control setting.



2. Changing the Tone Control type

Press the ◀ or ▶ buttons to cycle through the different Tone Control types.

- * To reset the Tone Control setting to the default type, press the ◀ and ▶ buttons simultaneously.
- * Any changes made to the Tone Control setting will remain until the power is turned off.
- * Preferred Tone Control settings can be stored to a Registration Memory for convenient recall, or to the Startup Setting memory for automatic selection when the instrument is turned on. Please refer to pages 35 and 79 for more information.

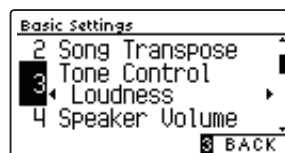
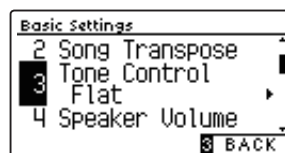

3. Exiting the Tone Control setting

Press the [3] FUNCTION button (BACK) to exit the Tone Control setting and return to the Function Menus screen.

■ Adjusting the Brilliance level

When the Brilliance tone control type is selected:

Press the [2] FUNCTION button (EDIT), then press the ◀ or ▶ buttons to increase/decrease the value of the Brilliance setting.

- * The Brilliance value can be adjusted within the range of -10~+10.

Press the [3] FUNCTION button (BACK) to exit the Brilliance setting and return to the Tone Control setting.

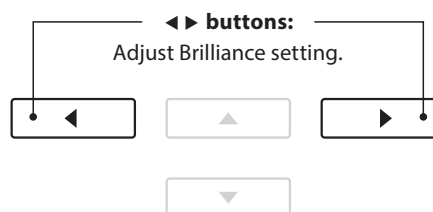

User Tone Control

The User Tone Control option allows finer control over the instrument's sound character, allowing the volume of four frequency bands to be adjusted individually. It is also possible to adjust the frequency range of the mid-low and mid-high frequency bands.

■ User Tone Control setting

No.	User Tone Control	Description
1	Low	Adjusts the volume of the low range frequency band (20~100 Hz).
2	Mid-low Frequency	Adjusts the frequency of the mid-low band (200~4000 Hz).
	Mid-low dB	Adjusts the volume of the mid-low range frequency band.
3	Mid-high Frequency	Adjusts the frequency of the mid-high band (200~4000 Hz).
	Mid-high dB	Adjusts the volume of the mid-high range frequency band.
4	High	Adjusts the volume of the high range frequency band (5000~8000 Hz).

1. Selecting the User Tone Control setting

After selecting the Tone Control setting (page 72):

Press the ◀ or ▶ buttons to select the User Tone Control type, then press the [2] FUNCTION button (EDIT).

The User Tone Control screen will be shown in the LCD display.



2. Selecting and adjusting the User Tone Control settings

Press the ▼ or ▲ buttons to select the User Tone Control setting. Press the ◀ or ▶ buttons to increase or decrease the value of the selected User Tone Control setting.

* Each User Tone Control band can be adjusted within the range of -6 dB~+6 dB.

* To reset the User Tone Control setting to the default type, press the ◀ and ▶ buttons simultaneously.

* Any changes made to the User Tone Control setting will remain until the power is turned off.

* Preferred User Tone Control settings can be stored to the Startup Setting memory for convenient recall. Please refer to page 79 for more information.

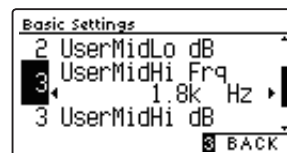
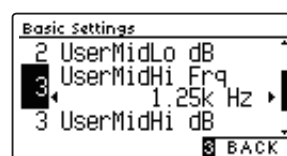

3. Exiting the User Tone Control setting

Press the [3] FUNCTION button (BACK) to exit the User Tone Control setting and return to the Tone Control setting.

4 Speaker Volume

The Speaker Volume setting allows the maximum volume level of the CN39 digital piano's speaker output to be reduced, providing finer adjustment control over the master volume. This setting can also function as a volume limiter, preventing the instrument from being played too loudly in the home or classroom etc.

* This setting does not affect the headphones volume.

■ Speaker Volume setting

Speaker Volume	Description
Normal (default)	The instrument's speakers will output sound at the normal volume level.
Low	The instrument's speakers will output sound at a reduced volume level.

1. Selecting the Speaker Volume setting

After entering the Basic Settings menu (page 69):

Press the ▼ or ▲ buttons to select the Speaker Volume setting.

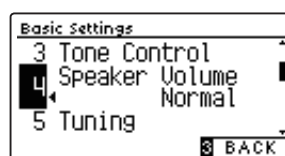

2. Changing the Speaker Volume type

Press the ◀ or ▶ buttons to alternate between 'Normal' and 'Low' Speaker Volume settings.

- * To reset the Speaker Volume setting to the default setting, press the ◀ and ▶ buttons simultaneously.
- * Any changes made to the Speaker Volume setting will remain until the power is turned off.
- * Preferred Speaker Volume settings can be stored to the Startup Setting memory for convenient recall. Please refer to page 79 for more information.

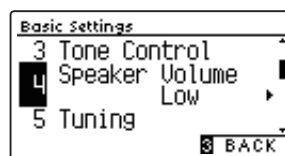
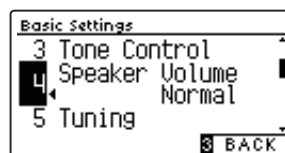

3. Exiting the Speaker Volume setting

Press the [FUNCTION] button (BACK) to exit the Speaker Volume setting and return to the Function Menus screen.

5 Tuning

The Tuning setting allows the overall pitch of the CN39 digital piano to be raised and lowered in 0.5 Hz steps, and may therefore prove useful when playing with other instruments.

1. Selecting the Tuning setting

After entering the Basic Settings menu (page 69):

Press the ▼ or ▲ buttons to select the Tuning setting.

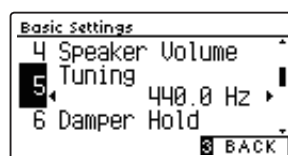

2. Adjusting the Tuning value

Press the ◀ or ▶ buttons to increase or decrease the value of the Tuning setting.

* The Tuning value can be adjusted within the range of 427.0~453.0 Hz.

* To reset the Tuning setting to the default value, press the ◀ and ▶ buttons simultaneously.

* Any changes made to the Tuning setting will remain until the power is turned off.

* Preferred Tuning settings can be stored to a Registration Memory for convenient recall, or to the Startup Setting memory for automatic selection when the instrument is turned on. Please refer to pages 35 and 79 for more information.

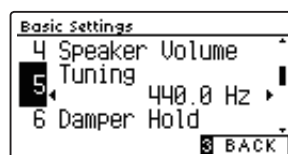

3. Exiting the Tuning setting

Press the [3] FUNCTION button (BACK) to exit the Tuning setting and return to the Function Menus screen.

6 Damper Hold

The Damper Hold setting is used to determine whether sounds such as organ or strings should be sustained continuously when the sustain (damper) pedal is pressed, or whether these sounds should decay, naturally.

■ Damper Hold setting

Damper Hold	Description
Off (default)	Organ, strings, etc. sounds will gradually decay, even while the sustain pedal is pressed.
On	Organ, strings, etc. sounds will be sustained continuously while the sustain pedal is pressed.

1. Selecting the Damper Hold setting

After entering the Basic Settings menu (page 69):

Press the ▼ or ▲ buttons to select the Damper Hold setting.

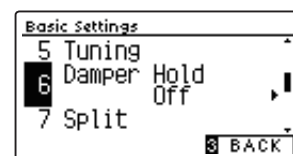

2. Changing the Damper Hold setting

Press the ◀ or ▶ buttons to turn the Damper Hold setting on or off.

* To reset the Damper Hold setting to the default setting, press the ◀ and ▶ buttons simultaneously.

* Any changes made to the Damper Hold setting will remain until the power is turned off.

* Preferred Damper Hold settings can be stored to a Registration Memory for convenient recall, or to the Startup Setting memory for automatic selection when the instrument is turned on. Please refer to pages 35 and 79 for more information.

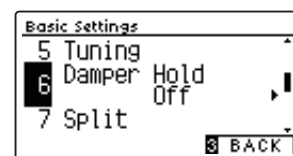

3. Exiting the Damper Hold setting

Press the [FUNCTION] button (BACK) to exit the Damper Hold setting and return to the Function Menus screen.

7 Split

The Split setting provides an alternative method to enabling the Split Mode function, and may prove useful in teaching environments or situations where the function should be enabled automatically every time the CN39 digital piano is turned on.

When enabled, all Split Mode control operations are identical to those explained on page 22.

■ Split setting

Split	Description
Off (default)	Split Mode will be turned off by default.
On	Split Mode will be turned on by default.

1. Selecting the Split setting

After entering the Basic Settings menu (page 69):

Press the ▼ or ▲ buttons to select the Split setting.



2. Changing the Split setting

Press the ◀ or ▶ buttons to turn the Split setting on or off.

- * To reset the Split setting to the default setting, press the ◀ and ▶ buttons simultaneously.
- * When Split is turned on, the Four Hands Mode will be turned off automatically.
- * Any changes made to the Split setting will remain until the power is turned off.
- * Preferred Split settings can be stored to a Registration Memory for convenient recall, or to the Startup Setting memory for automatic selection when the instrument is turned on. Please refer to pages 35 and 79 for more information.

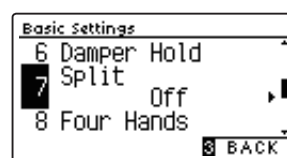

3. Exiting the Split setting

Press the [3] FUNCTION button (BACK) to exit the Split setting and return to the Function Menus screen.

8 Four Hands

The Four Hands setting provides an alternative method to enabling the Four Hands Mode function, and may prove useful in teaching environments or situations where the function should be enabled automatically every time the CN39 digital piano is turned on.

When enabled, all Four Hands Mode control operations are identical to those explained on page 24.

■ Four Hands setting

Four Hands	Description
Off (default)	Four Hands Mode will be turned off by default.
On	Four Hands Mode will be turned on by default.

1. Selecting the Four Hands setting

After entering the Basic Settings menu (page 69):

Press the ▼ or ▲ buttons to select the Four Hands setting.



2. Changing the Four Hands setting

Press the ◀ or ▶ buttons to turn the Four Hands setting on or off.

- * To reset the Four Hands setting to the default setting, press the ◀ and ▶ buttons simultaneously.
- * When Four Hands Mode is turned on, the Split function will be turned off automatically.
- * Any changes made to the Four Hands setting will remain until the power is turned off.
- * Preferred Four Hands settings can be stored to a Registration Memory for convenient recall, or to the Startup Setting memory for automatic selection when the instrument is turned on. Please refer to pages 35 and 79 for more information.



3. Exiting the Four Hands setting

Press the [3] FUNCTION button (BACK) to exit the Four Hands setting and return to the Function Menus screen.

9 Startup Setting

The Startup Setting function allows preferred panel functions/settings to be stored in the instrument's memory, and automatically recalled as the default settings every time the CN39 digital piano is turned on.

* Startup Settings can also be saved to and loaded from USB memory devices. Please refer to pages 123/118 for more information.

■ Functions/Settings stored in the Startup Setting memory

Functions	Settings
Selected sound (including primary sound for each category)	Basic Settings (with exceptions)
Dual Mode / Split Mode / Four Hands Mode (including settings)	Virtual Technician Settings
Reverb, Effects (Type, Settings)	MIDI Settings
Metronome (Beat, Tempo, Volume)	Headphone Settings

* Changes made to the Auto Display Off, Auto Power Off, and Bluetooth settings will be stored to the Startup Setting memory automatically.

* For a complete listing of the settings that can be stored to Startup Setting memory, please refer to pages 140~141.

1. Selecting the Startup Setting function

After entering the Basic Settings menu (page 69):

Press the ▼ or ▲ buttons to select the Startup Setting function.



2. Storing current settings to the Startup Setting memory

Press the REC button.

A confirmation message will be shown in the LCD display, and the current panel settings will be stored to the Startup Setting memory.

* The Factory Reset function can be used to restore all settings to their default values. Please refer to page 80 for more information.



3. Exiting the Startup Setting function

Press the [FUNCTION] button (BACK) to exit the Startup Setting function and return to the Function Menus screen

10 Factory Reset

The Factory Reset function clears any settings stored using the User Memory function, restoring the CN39 digital piano to its factory default settings.

* This function will not clear registration memories or recorder songs stored in internal memory.

1. Selecting the Factory Reset function

After entering the Basic Settings menu (page 69):

Press the ▼ or ▲ buttons to select the Factory Reset setting.



2. Restoring factory settings

Press the REC button.

A confirmation message will be shown in the LCD display, and all settings will be restored to their default values.

After completion, the normal playing mode screen will be shown in the display automatically.



11 Auto Display Off

The Auto Display Off setting can be used to automatically turn off the display when the control panel is not being operated.

* This setting will be stored automatically, and recalled every time the instrument is turned on.

* To prevent the CN39 digital piano's OLED display from 'burn in' as a result of showing the same screen for an extended period of time, this setting is enabled by default.

■ Auto Display Off settings

Auto Display Off	Description
15 sec.	The display will turn off automatically after 15 seconds of inactivity.
5 min. (default)	The display will turn off automatically after 5 minutes of inactivity.
30 min.	The display will turn off automatically after 30 minutes of inactivity.

* When the display turns off automatically, pressing any control panel button will turn it on again.

1. Selecting the Auto Display Off setting

After entering the Basic Settings menu (page 69):

Press the ▼ or ▲ buttons to select the Auto Display Off setting.



2. Changing the Auto Display Off setting

Press the ◀ or ▶ buttons to change the Auto Display Off setting.

* To reset the Auto Display Off setting to the default setting, press the ◀ and ▶ buttons simultaneously.

* The Auto Display Off setting will be stored automatically, and recalled every time the instrument is turned on.



3. Exiting the Auto Display Off setting

Press the [3] FUNCTION button (BACK) to exit the Auto Power Off setting and return to the Function Menus screen.

12 Auto Power Off

The Auto Power Off setting can be used to automatically turn off the instrument after a specified period of inactivity. This function may be enabled by default, depending on the market location.

* This setting will be stored automatically, and recalled every time the instrument is turned on.

■ Auto Power Off settings

Auto Power Off	Description
Off	The Auto Power Off function is disabled.
15 min.	The instrument will turn off automatically after 15 minutes of inactivity.
60 min.	The instrument will turn off automatically after 60 minutes of inactivity.
120 min.	The instrument will turn off automatically after 120 minutes of inactivity.

* The default Auto Power Off setting varies depending on market location.

1. Selecting the Auto Power Off setting

After entering the Basic Settings menu (page 69):

Press the ▼ or ▲ buttons to select the Auto Power Off setting.

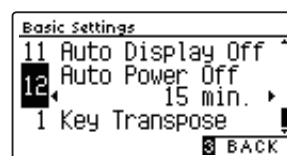

2. Changing the Auto Power Off setting

Press the ◀ or ▶ buttons to change the Auto Power Off setting.

* To reset the Auto Power Off setting to the default setting, press the ◀ and ▶ buttons simultaneously.

* The Auto Power Off setting will be stored automatically, and recalled every time the instrument is turned on.

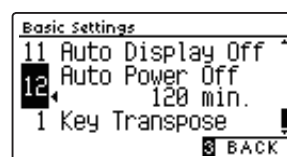
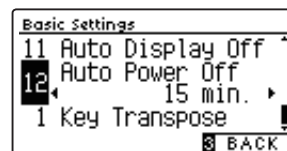

3. Exiting the Auto Power Off setting

Press the [3] FUNCTION button (BACK) to exit the Auto Power Off setting and return to the Function Menus screen.

Virtual Technician Settings

The Virtual Technician settings of the CN39 digital piano allow the player to adjust advanced parameters such as hammer hardness, action regulation, cabinet size, and a variety of other acoustic characteristics, in order to suit their personal preferences. Virtual Technician settings are adjusted and stored independently for each sound, variation, allowing flexible control over the characteristics of each piano voice.

* The table below indicates which Virtual Technician settings affect to all sounds, or acoustic piano and electric piano sounds only.

Virtual Technician Settings

No.	Setting	Description	All	AP	EP	Default
1	Touch Curve	Adjust the touch sensitivity of the keyboard.	•			Normal
2	Voicing	Adjust the tonal character of the instrument.	•			Normal
	User Voicing	Adjust the individual voicing of each of the 88 keys.	•			–
3	Damper Resonance	Adjust the resonance that is heard when pressing the damper pedal.		•		5
4	Damper Noise	Adjust the sound that is heard when pressing the damper pedal.		•		5
5	String Resonance	Adjust the resonance that is heard when notes are held.		•		5
6	Undamped Str. Res.	Adjust the resonance produced by the topmost undamped strings.		•		5
7	Cabinet Resonance	Adjust the resonance produced by the piano cabinet itself.		•		1
8	Key-off Effect	Adjust the sound that is heard when keys are released.		•	•	5
9	Fall-back Noise	Adjust the sound that is heard when the key action falls back.		•		5
10	Hammer Delay	Adjust the delay of the hammer striking strings when playing pianissimo.		•		Off
11	Topboard Simulation	Adjust the position of the grand piano topboard.		•		Open 3
12	Decay Time	Adjust the decay time of the piano sound while the keys are pressed.	•			5
13	Minimum Touch	Adjust the minimum key velocity required to produce a sound.		•	•	1
14	Stretch Tuning	Adjust the level of stretch tuning for equal temperaments.	•			Normal
	User Tuning	Adjust the individual tuning of each of the 88 keys.	•			–
15	Temperament	Adjust the tuning system to suit Renaissance and Baroque periods etc.	•			Equal Temp.
	User Temperament	Adjust the tuning of each note in the scale to a custom temperament.	•			–
16	Temperament Key	Adjust the key of the selected tuning system.	•			C
17	Key Volume	Adjust the volume balance of the keyboard.	•			Normal
	User Key Volume	Adjust the individual volume of each of the 88 keys.	•			–
18	Half-Pedal Adjust	Adjust the point at which the damper pedal begins to sustain the sounds.	•			5
19	Soft Pedal Depth	Adjust the depth/effectiveness of the soft pedal.	•			3

* Default settings will be shown in the first LCD display illustration (i.e. Step 1) for each setting explanation below.

Entering the Virtual Technician menu

While the normal playing mode screen is shown in the LCD display:

Press the **2** FUNCTION button (MENU).

The Function menus will be shown in the LCD display.

Press the **▼** or **▲** buttons to select the Virtual Technician menu.

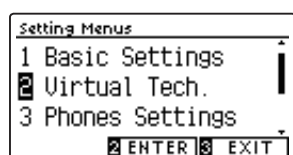

Press the **2** FUNCTION button (ENTER) again to enter the Virtual Technician menu.

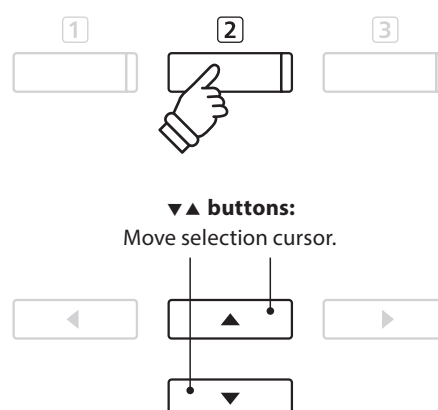

* It is also possible to enter the Virtual Technician menu by pressing and holding the **2** FUNCTION button (VT) on the normal playing screen.

Virtual Technician Settings

■ Selecting and adjusting the desired setting

After entering the Virtual Technician menu:

Press the ▼ or ▲ buttons to move the selection cursor over the desired setting.

Press the ◀ or ▶ buttons to adjust the selected setting.

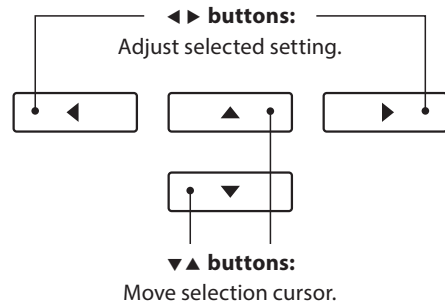

* To reset the current Virtual Technician setting to the default value, press the ◀ and ▶ buttons simultaneously.

■ Showing the Virtual Technician Help screen

Press the ① FUNCTION button (HELP).

A brief explanation about the currently selected Virtual Technician parameter will be shown in the LCD display.

Press the ▼ or ▲ buttons to scroll through the explanation if necessary.

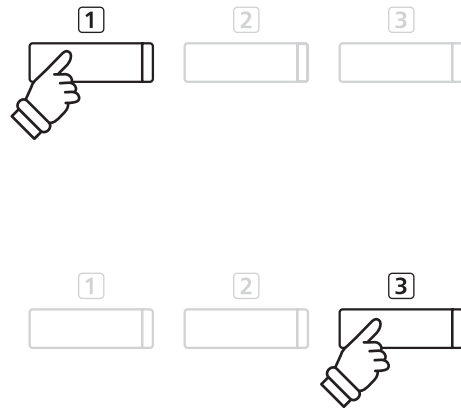
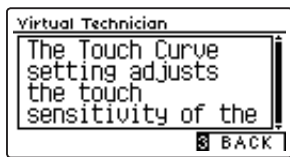

Press the ③ FUNCTION button (BACK) to return to the Virtual Technician menu.

■ Storing the Virtual Technician setting to the selected sound

After adjusting a Virtual Technician parameter:

Press the ② FUNCTION button (STORE).

The adjusted Virtual Technician parameter setting will be used as the default setting for the currently selected sound, and a confirmation message will briefly be shown in the LCD display.

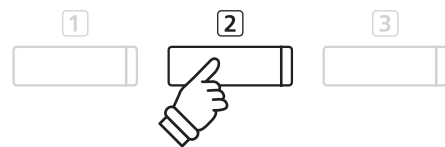

* Virtual Technician settings are adjusted and stored independently for each sound variation.

* Only values for the currently selected Virtual Technician setting will be stored. In order to store all of the Virtual Technician settings simultaneously, it is recommended to use a Registration memory (page 35) or the Startup Setting function (page 79).

■ About Stored Virtual Technician settings

As mentioned above, the Virtual Technician settings are adjusted and stored independently for each sound. This allows different Virtual Technician adjustments to be made for each piano voice. For example, it may be desirable to voice the SK Concert Grand piano a little brighter than the EX Concert Grand piano, or increase the Damper, String, and Cabinet Resonances of the Studio Grand sound while leaving the Mellow Grand sound unchanged.

1 Touch Curve

As with an acoustic piano, the CN39 digital piano produces a louder sound when the keys are struck with force, and a softer sound when the keys are played gently. The volume and tonal character change in relation to the strength and velocity of playing – on a digital piano this system is referred to as ‘touch sensitivity’.

The Touch Curve setting allows the touch sensitivity of the keyboard to be conveniently adjusted. There are ten different preset touch curve settings available, with two additional ‘User’ settings that allow performers to customise the instrument’s keyboard responsiveness to suit their individual playing style.

The default ‘Normal’ setting is designed to accurately recreate the touch of a Kawai concert grand piano. However, if the keyboard feels too light, or fortissimo playing is achieved too easily, it may be desirable to select a heavier touch curve. Alternatively, if the keyboard feels too heavy, or fortissimo playing is too difficult to achieve, it may be desirable to select a lighter touch curve.

* This Virtual Technician setting will affect all sounds.

■ Touch Curve types

Touch Curve	Description
Light (4/3/2/1)	Light touch curves require less striking force to achieve a forte note, and are therefore recommended for players with a delicate touch. The key touch will become progressively lighter as the number increases.
Normal (default)	Reproduces the standard touch sensitivity of an acoustic piano.
Heavy (1/2/3/4)	Heavy touch curves require more striking force in order to achieve a forte, and are therefore recommended for players with stronger fingers. The key touch will become progressively heavier as the number increases.
Off (constant)	A constant volume is produced regardless of how hard the keys are struck. * This touch curve intended for playing sounds of instruments that have a fixed dynamic range (e.g. organ and harpsichord).
User 1 / User 2	A custom touch curve, created to suit an individual’s personal playing style.

■ Touch Curve graph

The illustration below provides a visual representation of the different Touch Curve settings.

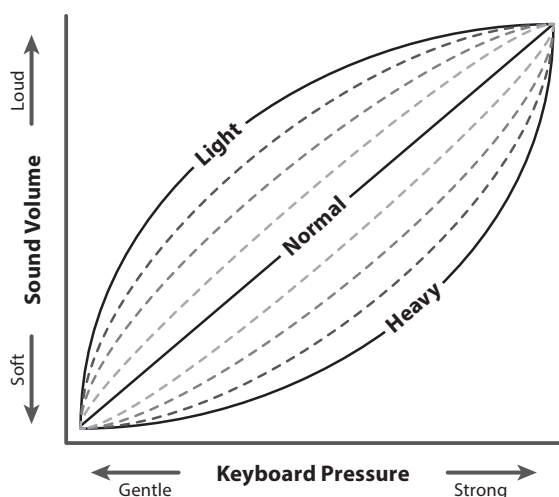

Virtual Technician Settings

1. Selecting the Touch Curve setting

After entering the Virtual Technician menu (page 83):

Press the ▼ or ▲ buttons to select the Touch Curve setting.



2. Changing the Touch Curve type

Press the ◀ or ▶ buttons to cycle through the different Touch Curve types.

- * To reset the Touch Curve setting to the default type, press the ◀ and ▶ buttons simultaneously.
- * Any changes made to the Touch Curve type or User Touch setting will remain until the power is turned off.
- * Preferred Touch Curve settings can be stored to the sound's memory, or a Registration memory for convenient recall. Please refer to pages 84 and 35 for more information.



3. Exiting the Touch Curve setting

Press the [3] FUNCTION button (BACK) to exit the Touch Curve setting and return to the Function Menus screen.

User Touch Curve

■ Creating a User Touch Curve

After selecting the Touch Curve setting:

Press the ◀ or ▶ buttons to select the User 1 or User 2 touch curve, then press the REC button.

A message will be shown, prompting for the keyboard to be played.

Play the piano dynamically from very soft to very loud, allowing the instrument to examine the personal playing technique.

- * More than one attempt may be required in order to create an accurate User Touch Curve.
- * Reducing the master volume fader to the lowest position before creating the User Touch Curve may help to reduce user distractions, thus improving accuracy.

Press the PLAY/STOP button.

The new User Touch Curve will be stored to the User touch type, and selected automatically.

- * If desired, press the [2] FUNCTION button (STORE) to ensure the User touch type is retained after the instrument's power is turned off.



2 Voicing

On an acoustic piano, the shape, density, and texture of the hammers all influence on the tonal character of the instrument's sound. Technicians utilise a variety of tools such as needles, files, and brushes to manipulate these hammer felts, with the ultimate goal of achieving a balanced tonal character across the keyboard.

The Voicing setting recreates various hammer properties, allowing the overall tonal character of the CN39 digital piano to be adjusted. There are six different preset voicing settings available (applied uniformly to all keys), with an additional four 'User' settings that allow players to perform custom adjustments on each individual key.

While the default 'Normal' voicing setting should be appropriate for a broad range of musical genres, it may be desirable to select a softer, more mellow tonal character for romantic pieces, or a brighter, more aggressive tone for modern styles.

* This Virtual Technician setting will affect all sounds.

Voicing types

Voicing type	Description
Normal (default)	The normal tonal character of an acoustic piano throughout the entire dynamic range.
Mellow 1	A softer, more mellow tonal character throughout the entire dynamic range.
Mellow 2	An even soften tonal character than Mellow 1.
Dynamic	A tonal character that changes dramatically from mellow to bright, depending on the strength of key strike.
Bright 1	A bright tonal character throughout the entire dynamic range.
Bright 2	An even brighter tonal character than Bright 1.
User 1~4	A custom tonal character, allowing each key to be individually voiced.

1. Selecting the Voicing setting

After entering the Virtual Technician menu (page 83):

Press the ▼ or ▲ buttons to select the Voicing setting.



2. Changing the Voicing type

Press the ◀ or ▶ buttons to cycle through the different Voicing types.

- * To reset the Voicing setting to the default type, press the ◀ and ▶ buttons simultaneously.
- * Any changes made to the Voicing setting will remain until the power is turned off.
- * Preferred Voicing settings can be stored to the sound's memory, or a Registration memory for convenient recall. Please refer to pages 84 and 35 for more information.



3. Exiting the Voicing setting

Press the [3] FUNCTION button (BACK) to exit the Voicing setting and return to the Function Menus screen.

User Voicing

The User Voicing function allows each of the 88 keys to be voiced individually.

1. Selecting the User Voicing type

After selecting the Voicing setting:

Press the ◀ or ▶ buttons to select the User Voicing type.

* Up to four different User Voicing memories can be created and stored.

Press the [2] FUNCTION button (EDIT).

The User Voicing screen will be shown in the LCD display.



2. Selecting the note, adjusting the User Voicing value

Press the ▼ or ▲ buttons to select the desired note to be adjusted.

* To select a note directly, press and hold the [2] FUNCTION button (+ KEY) then press the desired key.

Press the ◀ or ▶ buttons to adjust the User Voicing value for the selected note.

* The User Voicing value can be adjusted within the range of -5~+5, with lower values creating a mellower sound and higher values creating a brighter sound.

* To reset the User Voicing setting to the default value, press the ◀ and ▶ buttons simultaneously.

* The User Voicing values will be stored to the selected memory automatically.

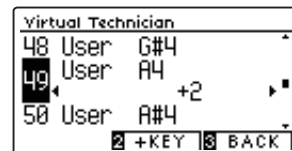
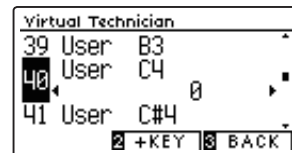

3. Exiting the User Voicing function

Press the [3] FUNCTION button (BACK) to exit the User Voicing screen and return to the Voicing setting.

3 Damper Resonance

Pressing the damper pedal of an acoustic piano raises all dampers, allowing the strings to vibrate freely. When a note or chord is played on the piano with the sustain pedal pressed, not only will the strings of the notes played vibrate, but also the strings of other notes, vibrating in sympathetic resonance.

The CN39 digital piano recreates this phenomenon, with the Damper Resonance setting allowing the volume of this resonance sound to be adjusted.

* This Virtual Technician setting will affect acoustic piano sounds only.

1. Selecting the Damper Resonance setting

After entering the Virtual Technician menu (page 83):

Press the ▼ or ▲ buttons to select the Damper Resonance setting.



2. Adjusting the Damper Resonance volume

Press the ◀ or ▶ buttons to increase or decrease the volume of the Damper Resonance setting.

* The Damper Resonance volume can be adjusted within the range of Off, 1~10, with higher values resulting in a more pronounced resonance.

* To reset the Damper Resonance setting to the default value, press the ◀ and ▶ buttons simultaneously.

* Any changes made to the Damper Resonance setting will remain until the power is turned off.

* Preferred Damper Resonance settings can be stored to the sound's memory, or a Registration memory for convenient recall. Please refer to pages 84 and 35 for more information.



3. Exiting the Damper Resonance setting

Press the [3] FUNCTION button (BACK) to exit the Damper Resonance setting and return to the Function Menus screen.

4 Damper Noise

When the damper pedal of an acoustic piano is pressed and released, it is often possible to hear the sound of the damper head touching and releasing the strings.

The CN39 digital piano reproduces this sound, with the Damper Noise setting allowing the volume of this sound to be adjusted. The speed at which the damper pedal is pressed will also influence the prominence of the damper noise, with fast pedalling creating a very pronounced sound.

* This Virtual Technician setting will affect acoustic piano sounds only.

1. Selecting the Damper Noise setting

After entering the Virtual Technician menu (page 83):

Press the ▼ or ▲ buttons to select the Damper Noise setting.



2. Adjusting the Damper Noise volume

Press the ◀ or ▶ buttons to increase or decrease the volume of the Damper Noise setting.

* The Damper Noise volume can be adjusted within the range of Off, 1~10, with higher values resulting in a more pronounced noise.

* To reset the Damper Noise setting to the default value, press the ◀ and ▶ buttons simultaneously.

* Any changes made to the Damper Noise setting will remain until the power is turned off.

* Preferred Damper Noise settings can be stored to the sound's memory, or a Registration memory for convenient recall. Please refer to pages 84 and 35 for more information.



3. Exiting the Damper Noise setting

Press the [3] FUNCTION button (BACK) to exit the Damper Noise setting and return to the Function Menus screen.

5 String Resonance

String Resonance refers to a phenomenon that exists in acoustic pianos whereby the strings of held notes resonate 'sympathetically' with other notes of the same harmonic overtone series.

The CN39 digital piano recreates this phenomenon, with the String Resonance setting allowing the volume of this resonance to be adjusted.

* This Virtual Technician setting will affect acoustic piano sounds only.

Demonstrating String Resonance

To experience the string resonance phenomenon, gently hold down the 'C' key as shown in the illustration below, then play (strike and release quickly) any of the keys marked with a ● symbol. In addition to the sound of each note played, it should also be possible to hear the strings of the first 'C' key resonating 'sympathetically', thus demonstrating String Resonance.

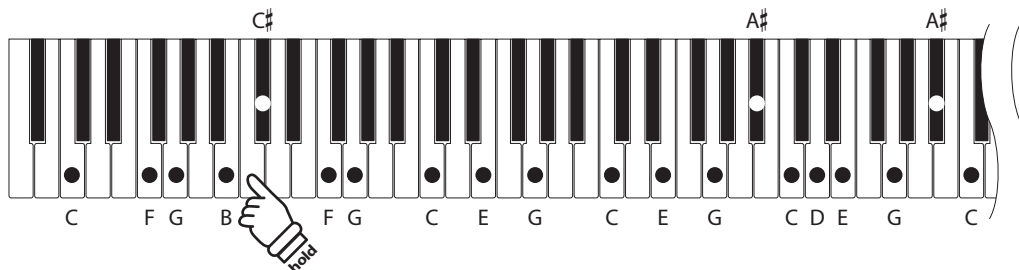

1. Selecting the String Resonance setting

After entering the Virtual Technician menu (page 83):

Press the ▼ or ▲ buttons to select the String Resonance setting.



2. Adjusting the String Resonance volume

Press the ◀ or ▶ buttons to increase or decrease the volume of the String Resonance setting.

* The String Resonance volume can be adjusted within the range of Off, 1~10, with higher values resulting in a more pronounced resonance.

* To reset the String Resonance setting to the default value, press the ◀ and ▶ buttons simultaneously.

* Any changes made to the String Resonance setting will remain until the power is turned off.

* Preferred String Resonance settings can be stored to the sound's memory, or a Registration memory for convenient recall. Please refer to pages 84 and 35 for more information.



3. Exiting the String Resonance setting

Press the [3] FUNCTION button (BACK) to exit the String Resonance setting and return to the Function Menus screen.

6 Undamped String Resonance

The dampers of an acoustic piano span almost the full width of the keyboard. However, the topmost 18 keys (approximately 1.5 octaves) do not incorporate dampers, as the shorter strings for these treble notes decay quickly and therefore do not need to be dampened.

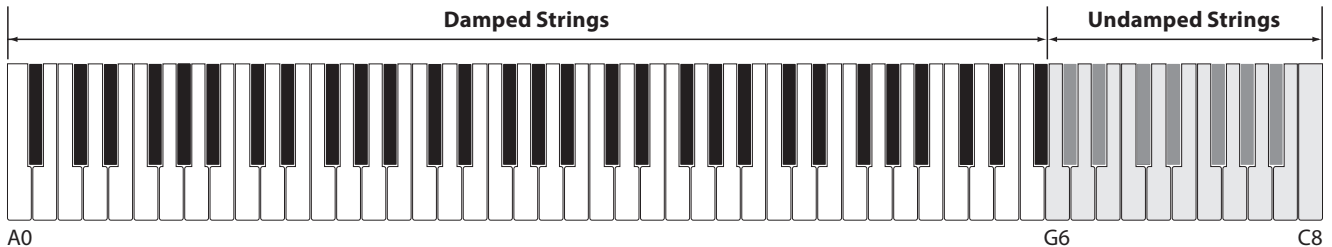

As a result, the strings of these 'undamped' treble notes are free to vibrate in sympathetic resonance with those of lower keys – independently of the damper pedal position – helping to enrich the sound with additional harmonics and tonal colour.

The CN39 digital piano recreates this phenomenon, with the Undamped String Resonance setting allowing the volume of this resonance sound to be adjusted.

* This Virtual Technician setting will affect acoustic piano sounds only.

1. Selecting the Undamped String Resonance setting

After entering the Virtual Technician menu (page 83):

Press the ▼ or ▲ buttons to select the Undamped String Resonance setting.



2. Adjusting the Undamped String Resonance volume

Press the ◀ or ▶ buttons to increase or decrease the volume of the Undamped String Resonance setting.

* The Undamped String Resonance volume can be adjusted within the range of Off, 1~10, with higher values resulting in a more pronounced resonance.

* To reset the Undamped String Resonance setting to the default value, press the ◀ and ▶ buttons simultaneously.

* Any changes made to the Undamped String Resonance setting will remain until the power is turned off.

* Preferred Undamped String Resonance settings can be stored to the sound's memory, or a Registration memory for convenient recall. Please refer to pages 84 and 35 for more information.



3. Exiting the Undamped String Resonance setting

Press the 3) FUNCTION button (BACK) to exit the Undamped String Resonance setting and return to the Function Menu screen.

7 Cabinet Resonance

While the fundamental sound of an acoustic piano is produced by vibrating strings, transmitting energy through a spruce soundboard, the cabinet of the instrument itself also contributes a variety of subtle tonal characteristics that enrich the playing and listening experience. The keybed, inner and outer rim, iron plate, and beams all play a role in disseminating sound energy, which in turn gives the piano a living, breathing quality.

The CN39 digital piano recreates these natural acoustic characteristics, with the Cabinet Resonance setting allowing the volume of this resonance sound to be adjusted.

* This Virtual Technician setting will affect acoustic piano sounds only.

1. Selecting the Cabinet Resonance setting

After entering the Virtual Technician menu (page 83):

Press the ▼ or ▲ buttons to select the Cabinet Resonance setting.

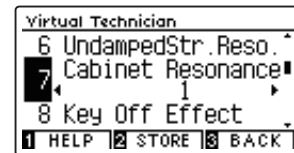

2. Adjusting the Cabinet Resonance volume

Press the ◀ or ▶ buttons to increase or decrease the volume of the Cabinet Resonance setting.

* The Cabinet Resonance volume can be adjusted within the range of Off, 1~10, with higher values resulting in a more pronounced resonance.

* To reset the Cabinet Resonance setting to the default value, press the ◀ and ▶ buttons simultaneously.

* Any changes made to the Cabinet Resonance setting will remain until the power is turned off.

* Preferred Cabinet Resonance settings can be stored to the sound's memory, or a Registration memory for convenient recall. Please refer to pages 84 and 35 for more information.



3. Exiting the Cabinet Resonance setting

Press the [3] FUNCTION button (BACK) to exit the Cabinet Resonance setting and return to the Function Menus screen.

8 Key-off Effect

When playing an acoustic piano – particularly in the bass region of the keyboard – if a key is played with force and released quickly, it is often possible to hear the faint sound of the damper touching the strings immediately before the vibrations are stopped.

In addition, the speed at which keys are lifted will also affect the character of the sound. For example, when lifting the keys quickly (e.g. staccato playing) the 'release' portion of the sound will be noticeably shorter than when lifting the keys slowly (e.g. legato playing).

The CN39 digital piano reproduces both characteristics, with the Key-off Effect setting allowing the volume of the key-off sound to be adjusted, and the key-off release speed detection to be turned on or off.

* This Virtual Technician setting will affect acoustic piano sounds, most electric piano sounds, as well as the Clavi and Wood Bass sounds.

1. Selecting the Key-off Effect setting

After entering the Virtual Technician menu (page 83):

Press the ▼ or ▲ buttons to select the Key-off Effect setting.



2. Adjusting the Key-off Effect volume

Press the ◀ or ▶ buttons to increase or decrease the volume of the Key-off Effect setting.

* The Key-off Effect volume can be adjusted within the range of Off, 1~10, with higher values resulting in a more pronounced effect.

* When the Key-Off Effect setting is set to Off, the key-off release speed detection will also be disabled, and the speed at which keys are lifted will not affect the character of the sound.

* To reset the Key-off Effect setting to the default value, press the ◀ and ▶ buttons simultaneously.

* Any changes made to the Key-off Effect setting will remain until the power is turned off.

* Preferred Key-off Effect settings can be stored to the sound's memory, or a Registration memory for convenient recall. Please refer to pages 84 and 35 for more information.

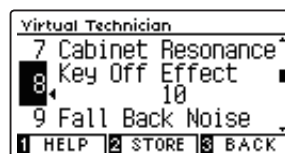
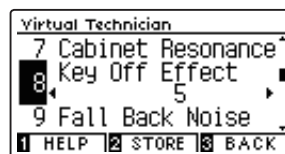

3. Exiting the Key-off Effect setting

Press the [3] FUNCTION button (BACK) to exit the Key-off Effect setting and return to the Function Menus screen.

9 Fall-back Noise

When playing an acoustic piano, it is often possible to hear the faint sound of the keyboard action returning (i.e. 'falling back') to the neutral position after a key is released.

The CN39 digital piano reproduces this sound, with the Fall-back Noise setting allowing the volume of this sound to be adjusted.

While the default value is intended to simulate the natural volume level of the keys as they return to their neutral position, it may occasionally be desirable to adjust the volume of this sound. For example, reducing the volume when playing very soft pieces, where the fall-back noise may become too prominent.

* This Virtual Technician setting will affect acoustic piano sounds, harpsichord sounds, and electric grand sounds.

1. Selecting the Fall-back Noise setting

After entering the Virtual Technician menu (page 83):

Press the ▼ or ▲ buttons to select the Fall-back Noise setting.



2. Adjusting the Fall-back Noise volume

Press the ◀ or ▶ buttons to increase or decrease the volume of the Fall-back Noise setting.

* The Fall-back Noise volume can be adjusted within the range of Off, 1~10, with higher values resulting in a more pronounced noise.

* To reset the Fall-back Noise setting to the default value, press the ◀ and ▶ buttons simultaneously.

* Any changes made to the Fall-back Noise setting will remain until the power is turned off.

* Preferred Fall-back Noise settings can be stored to the sound's memory, or a Registration memory for convenient recall. Please refer to pages 84 and 35 for more information.



3. Exiting the Fall-back Noise setting

Press the [3] FUNCTION button (BACK) to exit the Fall-back Noise setting and return to the Function Menus screen.

10 Hammer Delay

When playing pianissimo passages using an acoustic piano, there may be a perceived delay between a key being pressed and the hammer striking the strings.

If desired, the CN39 digital piano can recreate this delay, with the Hammer Delay setting allowing the delay length to be adjusted.

While the default value of 'Off' is intended to replicate a well-regulated concert grand piano, with an immediate connection between the keyboard and hammers, some players may find it desirable to introduce a minor delay, in order to mimic different types of piano or instruments with a slightly worn keyboard action.

* This Virtual Technician setting will affect acoustic piano sounds only.

1. Selecting the Hammer Delay setting

After entering the Virtual Technician menu (page 83):

Press the ▼ or ▲ buttons to select the Hammer Delay setting.



2. Adjusting the Hammer Delay value

Press the ◀ or ▶ buttons to increase or decrease the value of the Hammer Delay setting.

* The Hammer Delay value can be adjusted within the range of Off, 1~10, with higher values resulting in an increased delay.

* To reset the Hammer Delay setting to the default value, press the ◀ and ▶ buttons simultaneously.

* Any changes made to the Hammer Delay setting will remain until the power is turned off.

* Preferred Hammer Delay settings can be stored to the sound's memory, or a Registration memory for convenient recall. Please refer to pages 84 and 35 for more information.



3. Exiting the Hammer Delay setting

Press the [3] FUNCTION button (BACK) to exit the Hammer Delay setting and return to the Function Menus screen.

11 Topboard Simulation

When playing an acoustic grand piano, the position of the instrument's topboard (lid) affects both the volume and 'openness' of the tone produced. A fully open topboard allows sound waves to reflect off the polished lid surface and project into the room, while a closed lid has the opposite effect, resulting in a darker, more opaque tone.

The CN39 digital piano simulates these characteristics, with four different topboard positions.

* This Virtual Technician setting will affect acoustic piano sounds only.

■ Topboard positions

Topboard position	Description
Open 3 (default)	Simulates the character of a fully open topboard, with maximum sound projection.
Open 2	Simulates the character of a half open topboard, with reduced sound projection.
Open 1	Simulates the character of a partially open topboard, with limited sound projection.
Closed	Simulates the character of a closed topboard, with minimum sound projection.

1. Selecting the Topboard setting

After entering the Virtual Technician menu (page 83):

Press the ▼ or ▲ buttons to select the Topboard setting.



2. Changing the Topboard position

Press the ◀ or ▶ buttons to cycle through the different Topboard types.

* To reset the Topboard setting to the default position, press the ◀ and ▶ buttons simultaneously.

* Any changes made to the Topboard setting will remain until the power is turned off.

* Preferred Topboard settings can be stored to the sound's memory, or a Registration memory for convenient recall. Please refer to pages 84 and 35 for more information.



3. Exiting the Topboard setting

Press the [FUNCTION] button (BACK) to exit the Topboard setting and return to the Function Menus screen.

12 Decay Time

When playing an acoustic grand piano, the length of the instrument influences the speed at which held notes decay, with longer grand pianos (i.e. longer strings) characterised by longer decay times.

The CN39 digital piano simulates this characteristic, with the Decay Time setting allowing the length of decay while keys are pressed to be adjusted.

* This Virtual Technician setting will affect all sounds.

1. Selecting the Decay Time setting

After entering the Virtual Technician menu (page 83):

Press the ▼ or ▲ buttons to select the Decay Time setting.



2. Adjusting the Decay Time volume

Press the ◀ or ▶ buttons to increase or decrease the value of the Decay Time setting.

* The Decay Time value can be adjusted within the range of 1~10, with larger values resulting in increased decay times.

* To reset the Decay Time setting to the default value, press the ◀ and ▶ buttons simultaneously.

* Any changes made to the Decay Time setting will remain until the power is turned off.

* Preferred Decay Time settings can be stored to the sound's memory, or a Registration memory for convenient recall. Please refer to pages 84 and 35 for more information.



3. Exiting the Decay Time setting

Press the 3 FUNCTION button (BACK) to exit the Decay Time setting and return to the Function Menus screen.

13 Minimum Touch

The Minimum Touch setting allows the minimum key velocity required to produce a sound to be adjusted. By default, this setting recreates the extremely fine touch sensitivity of a concert grand piano, allowing a very soft sound to be produced with the slightest of key touches. However, it may be desirable to reduce this sensitivity, when wishing to recreate the sensitivity of a small grand piano or an upright piano.

* This Virtual Technician setting will affect acoustic piano sounds and most electric piano sounds.

1. Selecting the Minimum Touch setting

After entering the Virtual Technician menu (page 83):

Press the ▼ or ▲ buttons to select the Minimum Touch setting.



2. Adjusting the Minimum Touch value

Press the ◀ or ▶ buttons to increase or decrease the value of the Minimum Touch setting.

* The Minimum Touch value can be adjusted within the range of 1~20, with larger values requiring greater key force in order to produce a sound. For example, a value of 10 will require the keyboard to be played with a velocity of 10 or above in order to produce a sound.

* To reset the Minimum Touch setting to the default value, press the ◀ and ▶ buttons simultaneously.

* Any changes made to the Minimum Touch setting will remain until the power is turned off.

* Preferred Minimum Touch settings can be stored to the sound's memory, or a Registration memory for convenient recall. Please refer to pages 84 and 35 for more information.



3. Exiting the Minimum Touch setting

Press the [3] FUNCTION button (BACK) to exit the Minimum Touch setting and return to the Function Menus screen.

14 Stretch Tuning

Stretch tuning is a piano-specific tuning method used by acoustic piano technicians in which the lower octaves are tuned slightly flatter and the upper octaves are tuned slightly sharper to match the natural harmonics of an acoustic piano.

The Stretch Tuning setting allows the degree of stretch tuning to be adjusted when Equal temperament is selected, or for stretch tuning to be completely disabled. It is also possible to create custom tuning methods by adjusting the pitch of each individual key.

* This Virtual Technician setting will affect all sounds.

■ Stretch Tuning setting

Stretch Tuning	Description
Off	Stretch tuning is disabled.
Normal (default)	Normal stretch tuning is applied.
Wide	Wide stretch tuning is applied.
User 1~4	A custom tuning method, allowing the pitch of each key to be individual tuned.

1. Selecting the Stretch Tuning setting

After entering the Virtual Technician menu (page 83):

Press the ▼ or ▲ buttons to select the Stretch Tuning setting.



2. Changing the Stretch Tuning type

Press the ◀ or ▶ buttons to alternate between 'Off', 'Normal', 'Wide' and 'User 1~4' Stretch Tuning settings.

* To reset the Stretch Tuning setting to the default type, press the ◀ and ▶ buttons simultaneously.

* Any changes made to the Stretch Tuning setting will remain until the power is turned off.

* Preferred Stretch Tuning settings can be stored to the sound's memory, or a Registration memory for convenient recall. Please refer to pages 84 and 35 for more information.



3. Exiting the Stretch Tuning setting

Press the [3] FUNCTION button (BACK) to exit the Stretch Tuning setting and return to the Function Menus screen.

User Tuning

The User Tuning function allows each of the 88 keys to be tuned individually.

1. Selecting the User Tuning type

After selecting the *Stretch Tuning* setting (page 100):

Press the ◀ or ▶ buttons to select the User Tuning type.

* Up to four different User Tuning memories can be created and stored.

Press the [2] FUNCTION button (EDIT).

The User Tuning screen will be shown in the LCD display.



2. Selecting the note, adjusting the User Tuning value

Press the ▼ or ▲ buttons to select the desired note to be adjusted.

* To select a note directly, press and hold the [2] FUNCTION button (+ KEY) then press the desired key.

Press the ◀ or ▶ buttons to adjust the User Tuning value for the selected note.

* The User Tuning value can be adjusted within the range of -50~+50. A value of +20 indicates a pitch increase of 20 cents.

* To reset the User Tuning setting to the default value, press the ◀ and ▶ buttons simultaneously.

* Any changes made to the User Tuning setting will remain until the power is turned off.

* The User Tuning values will be stored to the selected memory automatically.

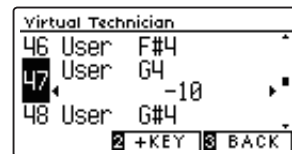
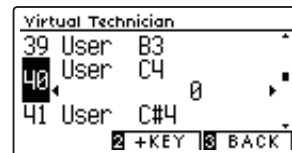

3. Exiting the User Tuning function

Press the [3] FUNCTION button (BACK) to exit the User Tuning tuning screen and return to the *Stretch Tuning* setting.

15 Temperament

The Temperament setting allows the tuning system used by the CN39 digital piano to be changed from the modern 'Equal Temperament' standard to one of the various temperaments popularised during the Renaissance and Baroque periods. It is also possible to create customised temperaments using the User Temperament function.

* This Virtual Technician setting will affect all sounds.

■ Temperament types

Temperament type	Description
Equal Temperament (default) (Equal)	This temperament is the most popular tuning method, and divides the scale into twelve equal semi-tones. This produces the same chordal intervals in all twelve keys, and has the advantage of limitless modulation of the key. However, the tonality of each key becomes less characteristic and no chord is in pure consonance.
Pure Temperament (Pure Major/Pure Minor)	This temperament, which eliminates dissonances for thirds and fifths, is still popular in choral music because of its perfect harmony. Any key modulation will result in dissonances. * The key of the temperament, and major/minor setting must be correctly matched.
Pythagorean Temperament (Pythagorean)	This temperament, which uses mathematical ratios to eliminate dissonance for fifths, is very limited for use with chords, but produces very characteristic melodic lines.
Meantone Temperament (Meantone)	This temperament, which uses a mean between a major and minor whole tone to eliminate dissonance for thirds, was devised to eliminate the lack of consonances experienced with certain fifths for the Mersenne pure temperament. It produces chords that are more beautiful than those played with equal temperament.
Werckmeister Temperament (Werckmeister) Kirnberger Temperament (Kirnberger)	These two temperaments are placed in between Meantone and Pythagorean. For music with few accidentals, this temperament produces the beautiful chords of the mean tone, but as accidentals increase, the temperament produces the characteristic melodies of the Pythagorean temperament. It is used primarily for classical music written in the Baroque era to revive the original characteristics.
User Temperament (User)	A custom temperament, created by raising or lowering the pitch of each note in the scale.

1. Selecting the Temperament setting

After entering the Virtual Technician menu (page 83):

Press the ▼ or ▲ buttons to select the Temperament setting.



2. Changing the Temperament type

Press the ◀ or ▶ buttons to cycle through the different Temperament types.

* To reset the Temperament setting to the default type, press the ◀ and ▶ buttons simultaneously.

* Any changes made to the Temperament setting will remain until the power is turned off.

* Preferred Temperament settings can be stored to the sound's memory, or a Registration memory for convenient recall. Please refer to pages 84 and 35 for more information.



3. Exiting the Temperament setting

Press the 3 FUNCTION button (BACK) to exit the Temperament setting and return to the Function Menus screen.

User Temperament

The User Temperament function allows custom temperaments to be created.

1. Selecting the User Temperament

After selecting the Temperament setting (page 102):

Press the ◀ or ▶ buttons to select the User temperament, then press the [2] FUNCTION button (EDIT).

The User Temperament screen will be shown in the LCD display.



2. Selecting the note, adjusting the user temperament value

Press the ▼ or ▲ buttons to select the desired note to be adjusted.

Press the ◀ or ▶ buttons to adjust the User Temperament value for the selected note.

* The User Temperament value can be adjusted within the range of -50~+50. A value of +20 indicates a pitch increase of 20 cents.

* To reset the User Temperament setting to the default value, press the ◀ and ▶ buttons simultaneously.

* Any changes made to the User Temperament setting will remain until the power is turned off.

* Preferred User Temperament settings can be stored to the sound's memory, or a Registration memory for convenient recall. Please refer to pages 84 and 35 for more information.

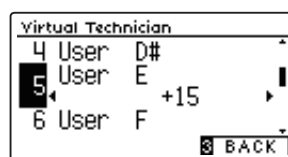
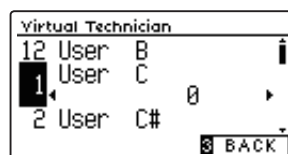

3. Exiting the User Temperament function

Press the [3] FUNCTION button (BACK) to exit the User Temperament screen and return to the Temperament setting.

16 Temperament Key

The Temperament Key setting allows the key of the selected temperament to be specified. When using a temperament other than Equal temperament, use this setting to specify the key signature of the piece.

* This Virtual Technician setting will affect all sounds.

* This setting will only affect the 'balance' of the tuning system, the pitch of the keyboard will remain unchanged.

1. Selecting the Temperament Key setting

After entering the Virtual Technician menu (page 83):

Press the ▼ or ▲ buttons to select the Temperament Key setting.



2. Adjusting the Temperament Key

After selecting a temperament other than Equal temperament types (page 102):

Press the ◀ or ▶ buttons to change the Temperament Key.

* The Temperament Key can be set within the range of C to B.

* To reset the Temperament Key setting to the default key, press the ◀ and ▶ buttons simultaneously.

* Any changes made to the Temperament Key setting will remain until the power is turned off.

* Preferred Temperament Key settings can be stored to the sound's memory, or a Registration memory for convenient recall. Please refer to pages 84 and 35 for more information.



3. Exiting the Temperament Key setting

Press the [3] FUNCTION button (BACK) to exit the Temperament Key setting and return to the Function Menus screen.

17 Key Volume

The Key Volume setting allows the volume of different regions of the keyboard to be subtly reduced. There are four different damping presets available, with an additional 'User' setting allowing players to perform subtle volume adjustments on each individual key.

While the default 'Normal' key volume setting should be appropriate for a broad range of musical genres, it may be desirable to experiment with different damping presets, or the User settings to attenuate or amplify the volume of individual keys.

* This Virtual Technician setting will affect all sounds.

■ Key Volume types

Key Volume	Description
Normal (default)	An evenly balanced volume throughout the keyboard.
High Damping	Gradually reduces the volume of the keyboard towards the treble region.
Low Damping	Gradually reduces the volume of the keyboard towards the bass region.
High & Low Damping	Gradually reduces the volume of the keyboard in both the treble and bass regions.
Center Damping	Gradually reduces the volume of the keyboard in the central region.
User 1~4	A custom keyboard volume, allowing the volume of each key to be individually adjusted.

1. Selecting the Key Volume setting

After entering the Virtual Technician menu (page 83):

Press the ▼ or ▲ buttons to select the Key Volume setting.



2. Changing the Key Volume type

Press the ◀ or ▶ buttons to cycle through the different Key Volume types.

* To reset the Key Volume setting to the default type, press the ◀ and ▶ buttons simultaneously.

* Any changes made to the Key Volume setting will remain until the power is turned off.

* Preferred Key Volume settings can be stored to the sound's memory, or a Registration memory for convenient recall. Please refer to pages 84 and 35 for more information.



3. Exiting the Key Volume function

Press the [3] FUNCTION button (BACK) to exit the Key Volume adjustment screen and return to the Functions Menus screen.

User Key Volume

The User Key Volume settings allows the volume of each of the 88 keys to be adjusted individually.

1. Selecting the User Key Volume type

After entering the Key Voicing setting:

Press the ◀ or ▶ buttons to select the User Key Volume type.

* Up to four different User Key Volume memories can be created and stored.

Press the [2] FUNCTION button (EDIT).

The User Key Volume screen will be shown in the LCD display.



2. Selecting the note, adjusting the User Key Volume value

Press the ▼ or ▲ buttons to select the desired note to be adjusted.

* To select a note directly, press and hold the [2] FUNCTION button (+ KEY) then press the desired key.

Press the ◀ or ▶ buttons to adjust the User Key Volume value for the selected note.

* The User Key Volume value can be adjusted within the range of -50~+50, with lower values attenuating the sound and higher values amplifying the sound.

* The User Key Volume values will be stored to the selected memory automatically.

* To reset the User Key Volume setting to the default value, press the ◀ and ▶ buttons simultaneously.

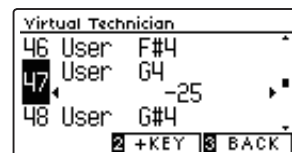
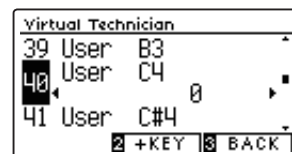

3. Exiting the User Key Volume function

Press the [3] FUNCTION button (BACK) to exit the User Key Volume screen and return to the Key Volume setting.

18 Half-Pedal Adjust

The Half-Pedal Adjust setting allows the point at which the damper/sustain pedal becomes effective (i.e. when the dampers of the piano begin to lift from the strings) to be adjusted. This setting may be useful for pianists that habitually rest their right foot on the damper/sustain pedal, but do not necessarily wish to sustain the sound.

* This Virtual Technician setting will affect all sounds.

1. Selecting the Half-Pedal Adjust setting

After entering the Virtual Technician menu (page 83):

Press the ▼ or ▲ buttons to select the Half-Pedal Adjust setting.



2. Adjusting the Half-Pedal Adjust value

Press the ◀ or ▶ buttons to increase or decrease the value of the Half-Pedal Adjust setting.

* The Half-Pedal Adjust value can be adjusted within the range of 1~10, with higher values resulting in a later damper pedal point.

* To reset the Half-Pedal Adjust setting to the default value, press the ◀ and ▶ buttons simultaneously.

* Any changes made to the Half-Pedal Adjust setting will remain until the power is turned off.

* Preferred Half-Pedal Adjust settings can be stored to the sound's memory, or a Registration memory for convenient recall. Please refer to pages 84 and 35 for more information.



3. Exiting the Half-Pedal Adjust setting

Press the [3] FUNCTION button (BACK) to exit the Half-pedal Point setting and return to the Function Menus screen.

19 Soft Pedal Depth

The Soft Pedal Depth setting adjusts the extent to which the soft (left) pedal of the CN39 digital piano softens the sound of played notes.

While the default value is intended to replicate the effectiveness of a concert grand Una Corda pedal, it may be desirable for players to increase or decrease the value of this setting to suit their playing style.

On an acoustic piano, pressing this Una Corda pedal shifts the keyboard action slightly to the right, causing the hammers to strike two strings instead of the usual three, thus reducing the volume of each note.

* This Virtual Technician setting will affect all sounds.

1. Selecting the Soft Pedal Depth setting

After entering the Virtual Technician menu (page 83):

Press the ▼ or ▲ buttons to select the Soft Pedal Depth setting.



2. Adjusting the Soft Pedal Depth value

Press the ◀ or ▶ buttons to increase or decrease the value of the Soft Pedal Depth setting.

- * The Soft Pedal Depth value can be adjusted within the range of 1~10, with higher values resulting in a softer sound.
- * To reset the Soft Pedal Depth setting to the default value, press the ◀ and ▶ buttons simultaneously.
- * Any changes made to the Soft Pedal Depth setting will remain until the power is turned off.
- * Preferred Soft Pedal Depth settings can be stored to the sound's memory, or a Registration memory for convenient recall. Please refer to pages 84 and 35 for more information.



3. Exiting the Soft Pedal Depth setting

Press the [3] FUNCTION button (BACK) to exit the Soft Pedal Depth setting and return to the Function Menus screen.

Phones Settings

The Phones Settings menu contains settings to select the SHS (Spatial Headphone Sound) mode, the type of headphones to be used, and the output volume of the connected headphones.

■ Phones Settings

No.	Setting	Description	Default setting
1	SHS Mode	Select the desired SHS (Spatial Headphone Sound) mode.	Normal
2	Phones Type	Select the type of headphones to be used with the instrument.	Normal
3	Phones Volume	Change the maximum volume level of the headphones output.	Normal

* Default settings will be shown in the first LCD display illustration (i.e. Step 1) for each setting explanation below.

■ Entering the Phones Settings menu

While the normal playing mode screen is shown in the LCD display:

Press the **2** FUNCTION button (MENU).

The Function menus will be shown in the LCD display.

Press the **▼** or **▲** buttons to select the Phones Settings menu.



Press the **2** FUNCTION button (ENTER) again to enter the Phones Settings menu.

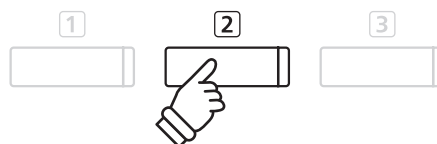
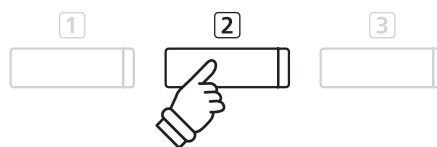

■ Selecting and adjusting the desired setting

After entering the Basic Settings menu:

Press the **▼** or **▲** buttons to move the selection cursor over the desired setting.

Press the **◀** or **▶** buttons to adjust the selected setting.

* To reset the current setting to the default value, press the **◀** and **▶** buttons simultaneously.

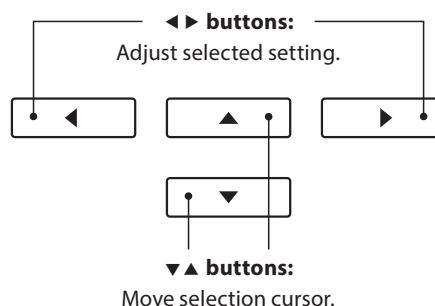

1 SHS Mode

Spatial Headphone Sound (SHS) is a special feature of the CN39 digital piano that enhances the depth and realism of the acoustic piano sound when listening through headphones or earphones.

The SHS Mode setting allows the player to select from one of three different acoustic presets that adjust the spatial positioning of the sound, while also helping to reduce auditory fatigue when using earphones or headphones for extended periods of time.

* This setting does not affect the speaker or Line Out sound.

■ SHS Mode setting

SHS Mode	Description
Off	Disable the Spatial Headphone Sound feature.
Forward	Front focused, somewhat narrow spatial positioning.
Normal (default)	Naturally balanced spatial positioning that is neither forward nor wide.
Wide	Wide, very open spatial positioning.

1. Selecting the SHS Mode setting

After entering the Phones Settings menu (page 109):

Press the ▼ or ▲ buttons to select the SHS Mode setting.

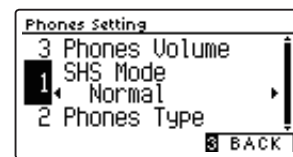

2. Changing the SHS Mode setting

Press the ◀ or ▶ buttons to cycle through the different SHS Mode types.

* To reset the SHS Mode setting to the default setting, press the ◀ and ▶ buttons simultaneously.

* Any changes made to the SHS Mode setting will remain until the power is turned off.

* Preferred SHS Mode settings can be stored to the Startup Setting memory for convenient recall. Please refer to page 79 for more information.

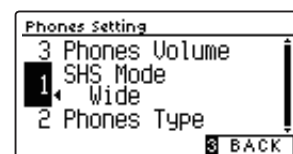
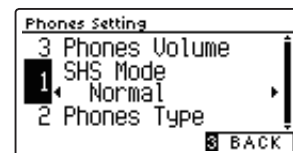

3. Exiting the SHS Mode setting

Press the [3] FUNCTION button (BACK) to exit the SHS Mode setting and return to the Function Menus screen.

2 Phones Type

The Phones Type setting optimises the sound of the CN39 digital piano when listening through different types of headphones or earphones.

* This setting does not affect the speaker or Line Out sound.

■ Phones Type setting

Phones Type	Description
Normal (default)	Disables headphone optimisation.
Open	Optimises the sound for open type headphones.
Semi-open	Optimises the sound for semi-open type headphones.
Closed	Optimises the sound for closed type headphones.
Inner-ear	Optimises the sound for inner-ear type headphones.
Canal	Optimises the sound for canal-type headphones.

1. Selecting the Phones Type setting

After entering the Phones Settings menu (page 109):

Press the ▼ or ▲ buttons to select the Phones Type setting.

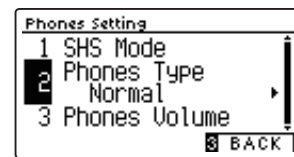

2. Changing the Phones Type setting

Press the ◀ or ▶ buttons to cycle through the different earphone/headphone types.

* To reset the Phones Type setting to the default setting, press the ◀ and ▶ buttons simultaneously.

* Any changes made to the Phones Type setting will remain until the power is turned off.

* Preferred Phones Type settings can be stored to the Startup Setting memory for convenient recall. Please refer to page 79 for more information.

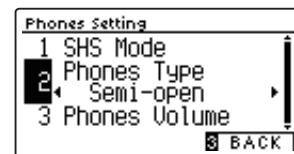
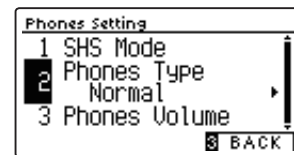

3. Exiting the Phones Type setting

Press the [FUNCTION] button (BACK) to exit the Phones Type setting and return to the Function Menus screen.

3 Phones Volume

The Phones Volume setting allows the maximum volume level of the headphones output to be increased.

The default setting for Phones Volume is 'Normal' in order to protect an individual's ears from excessive volume levels. The 'High' setting may be selected when using headphones with a high impedance, or in situations where it is desirable to increase the maximum volume level of the headphones output.

* This setting does not affect the speaker or Line Out sound.

■ Phones Volume setting

Phones Volume	Description
Normal (default)	The instrument's headphone connectors will output sound at the normal volume level.
High	The instrument's headphone connectors will output sound at an increased volume level.

1. Selecting the Phones Volume setting

After entering the Phones Settings menu (page 109):

Press the ▼ or ▲ buttons to select the Phones Volume setting.

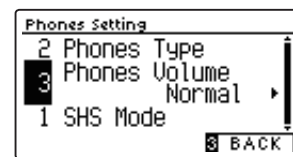

2. Changing the Phones Volume type

Press the ◀ or ▶ buttons to alternate between 'Normal' and 'High' Phones Volume settings.

* To reset the Phones Volume setting to the default setting, press the ◀ and ▶ buttons simultaneously.

* Any changes made to the Phones Volume setting will remain until the power is turned off.

* Preferred Phones Volume settings can be stored to the Startup Setting memory for convenient recall. Please refer to page 79 for more information.

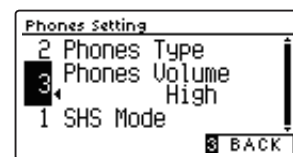
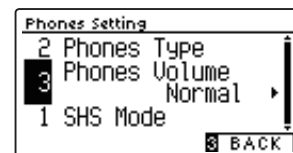

3. Exiting the Phones Volume setting

Press the [3] FUNCTION button (BACK) to exit the Phones Volume setting and return to the Function Menus screen.

USB MIDI (USB to Host connector)

The CN39 digital piano features a 'USB to Host' type connector, allowing the instrument to be connected to a computer using an inexpensive USB cable and utilised as a MIDI device. Depending on the type of computer and operating system installed, additional driver software may be required for USB MIDI communication to function correctly.

■ USB MIDI driver

Operating System	USB MIDI Driver Support
Windows Vista (SP1, SP2) Windows Vista 64-bit (SP1, SP2) Windows 7 (no SP, SP1) Windows 7 64-bit Windows 8 / 8.1 Windows 8 / 8.1 64-bit Windows 10 Windows 10 64-bit	<p>Additional USB MIDI driver software NOT required.</p> <p>The standard (built-in) Windows USB MIDI driver will be installed automatically when the instrument is connected to the computer.</p> <p>* After driver installation, ensure that the 'USB Audio Device' (Windows ME/Windows XP) or 'USB-MIDI' (Windows Vista/Windows 7/Windows 8) device is correctly selected in the application software.</p>
Windows Vista (no SP) Windows Vista 64-bit (no SP)	<p>USB MIDI is not supported.</p> <p>Please upgrade to service pack 1 or service pack 2.</p>
Windows 98 se Windows 2000 Windows ME Windows XP (no SP, SP1, SP2, SP3) Windows XP 64-bit	<p>USB MIDI is not supported.</p> <p>Please use a third-party MIDI interface for MIDI connection.</p>
Mac OS X	<p>Additional USB MIDI driver software NOT required.</p> <p>The standard (built-in) Mac OS X USB MIDI driver will be installed automatically when the instrument is connected to the computer.</p>
Mac OS 9	<p>USB MIDI is not supported.</p> <p>Please use a third-party MIDI interface for MIDI connection.</p>

■ USB MIDI information

- If the instrument's MIDI IN/OUT jacks and USB MIDI port are both connected simultaneously, the USB MIDI port will be given priority.
- Ensure that the instrument is turned OFF before attempting to connect the USB MIDI cable.
- When connecting the instrument to a computer using the USB MIDI port, there may be a short delay before communications begin.
- If the instrument is connected to a computer via a USB hub and USB MIDI communication becomes unreliable/unstable, please connect the USB MIDI cable directly to the one of the computer's USB ports.
- Disconnecting the USB MIDI cable suddenly, or turning the instrument on/off while using USB MIDI may cause computer instability in the following situations:
 - while installing the USB MIDI driver
 - while starting up the computer
 - while MIDI applications are performing tasks
 - while the computer is in energy saver mode
- If there are any further problems experienced with USB MIDI communication while the instrument is connected, please double-check all connections and relevant MIDI settings in the computer's operating system.

* 'Windows' is registered trademark of Microsoft Corporation.

* 'Macintosh' is registered trademark of Apple Computer, Inc.

* Other company names and product names mentioned referenced herein may be registered trademarks or trademarks of respective owners.

USB Menu

The USB Menu contains functions to load/save registration memories and recorder songs from/to a USB memory device. This menu also allows files to be renamed and deleted, and for the USB memory device to be formatted.

■ USB Menu functions

No.	Function	Description
1	Load Song	Load a recorder song from a USB memory device into the instrument's internal memory.
2	Load Registration All	Load a file containing all registration memories from a USB memory device into the instrument.
3	Load Registration Single	Load a single registration memory from a USB memory device into the instrument.
4	Load Startup Setting	Load a Startup Settings file from a USB memory device into the instrument.
5	Save Internal Song	Save a recorder song stored in internal memory to a USB memory device as a Kawai song file.
6	Save SMF Song	Save a recorder song stored in internal memory to a USB memory device as an SMF (MIDI) file.
7	Save Registration All	Save a file containing all registration memories from the instrument to a USB memory device.
8	Save Registration Single	Save a single registration memory from the instrument to a USB memory device.
9	Save Startup Setting	Save the instrument's current Startup Settings to a USB memory device.
10	Rename File	Rename a file stored on a USB memory device.
11	Delete File	Delete a file stored on a USB memory device.
12	Format USB	Format a USB memory device, erasing all stored data.

■ Entering the USB Menu menu

While the normal playing mode screen is shown in the LCD display:

Press the **2** FUNCTION button (MENU).

The Function menus will be shown in the LCD display.

Press the **▼** or **▲** buttons to select the USB Menu.

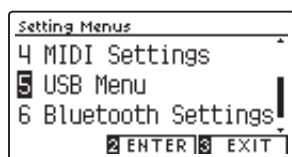

Press the **2** FUNCTION button (ENTER) again to enter the USB Menu.

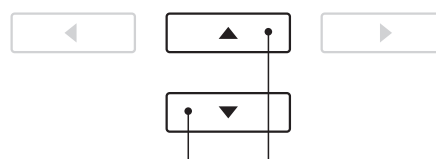
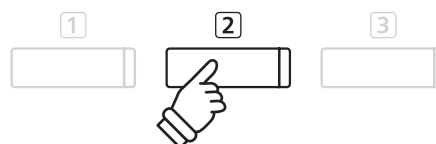

▼▲ buttons:

Move selection cursor.

■ Selecting the desired USB Menu function

After entering the USB Menu:

Press the **▼** or **▲** buttons to move the selection cursor over the desired function.

Press the **2** FUNCTION button (ENTER) to select the function.

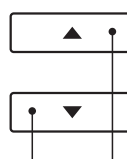

▼▲ buttons:

Move selection cursor.

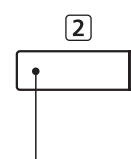

2 FUNCTION button:

Select function.

1 Load Song

The Load Song function is used to load CN39 recorder songs stored on a USB memory device into the instrument's internal memory.

* This function will overwrite any song data stored in the selected song memory.

* For more information about the instrument's 'Internal Song Recorder' feature, please refer to page 50.

1. Selecting the Load Song function

After entering the USB Menu (page 114):

Press the ▼ or ▲ buttons to select the Load Song function.

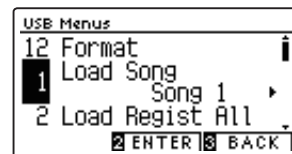

2. Selecting the song memory

Press the ◀ or ▶ buttons to select the internal song memory for the song to be loaded into.

* If a song memory contains song data, a * symbol will be shown.

Press the [2] FUNCTION button (ENTER).

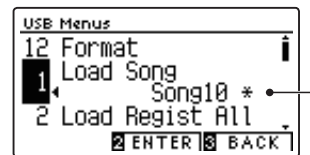

Song has been recorded

The file selection screen will be shown in the LCD display, listing CN39 song files stored on the USB memory device.

3. Selecting the song to be loaded

Press the ▼ or ▲ buttons to move the selection cursor, then press the [2] FUNCTION button (LOAD) to select the song file.

A confirmation message will be shown in the LCD display, prompting to confirm or cancel the load operation.

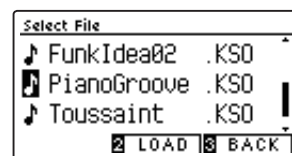

4. Confirming the load operation

Press the [1] FUNCTION button (YES) to confirm the load operation, or the [3] FUNCTION button (NO) to cancel.

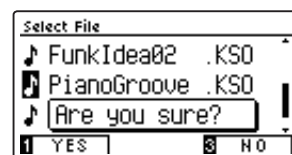

5. Exiting the Load Song function

Press the [3] FUNCTION button (BACK) to exit the Load Song function and return to the Function Menus screen.

To play back the loaded song file, please refer to the 'Playing a Song' instructions on page 52.

2 Load Registration All

The Load Registration All function is used to load a file containing all 16 CN39 registrations, stored on a USB memory device into the instrument's registration memories.

* This function will overwrite all existing Registration memories.

* For more information about the instrument's Registration feature, please refer to page 34.

1. Selecting the Load Registration All function

After entering the USB Menu (page 114):

Press the ▼ or ▲ buttons to select the Load Registration All function.

Press the **[2]** FUNCTION button (ENTER).

The file selection screen will be shown in the LCD display, listing CN39 registration files stored on the USB memory device.



2. Selecting the registration file to be loaded

Press the ▼ or ▲ buttons to move the selection cursor, then press the **[2]** FUNCTION button (LOAD) to select the registration file.

A confirmation message will be shown in the LCD display, prompting to confirm or cancel the load operation.



3. Confirming the load operation

Press the **[1]** FUNCTION button (YES) to confirm the load operation, or the **[3]** FUNCTION button (NO) to cancel.

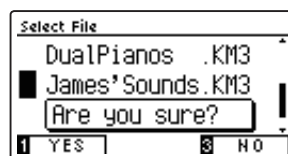

4. Exiting the Load Registration All function

Press the **[3]** FUNCTION button (BACK) to exit the Load Registration All function and return to the Function Menu screen.

To use the loaded registrations, please refer to the Registration instructions on page 34.

3 Load Registration Single

The Load Registration Single function is used to load a single CN39 registration file stored on a USB memory device into one of the instrument's registration memories.

* This function will overwrite the selected Registration memory.

* For more information about the instrument's Registration feature, please refer to page 34.

1. Selecting the Load Registration Single function

After entering the USB Menu (page 114):

Press the ▼ or ▲ buttons to select the Load Registration Single function.



2. Selecting the registration memory

Press the ◀ or ▶ buttons to select the registration memory for the new registration to be loaded into.

Press the [2] FUNCTION button (ENTER).

The file selection screen will be shown in the LCD display, listing CN39 song files stored on the USB memory device.



3. Selecting the registration file to be loaded

Press the ▼ or ▲ buttons to move the selection cursor, then press the [2] FUNCTION button (LOAD) to select the registration file.

A confirmation message will be shown in the LCD display, prompting to confirm or cancel the load operation.



4. Confirming the load operation

Press the [1] FUNCTION button (YES) to confirm the load operation, or the [3] FUNCTION button (NO) to cancel.



5. Exiting the Load Registration Single function

Press the [3] FUNCTION button (BACK) to exit the Load Registration Single function and return to the Function Menus screen.

To use the loaded registration, please refer to the Registration instructions on page 34.

4 Load Startup Setting

The Load Startup Setting function is used to load a CN39 startup setting file stored on a USB memory device into the instrument's startup memory. The loaded settings will be used as the default settings every time the CN39 digital piano is turned on.

* This function will overwrite the previously stored Startup Settings memory.

* For more information about the instrument's Startup Setting feature, please refer to page 79.

1. Selecting the Load Startup Setting function

After entering the USB Menu (page 114):

Press the ▼ or ▲ buttons to select the Load Startup Setting function.

Press the **[2]** FUNCTION button (ENTER).

The file selection screen will be shown in the LCD display, listing CN39 startup settings files stored on the USB memory device.



2. Selecting the startup settings file to be loaded

Press the ▼ or ▲ buttons to move the selection cursor, then press the **[2]** FUNCTION button (LOAD) to select the startup settings file.

A confirmation message will be shown in the LCD display, prompting to confirm or cancel the load operation.

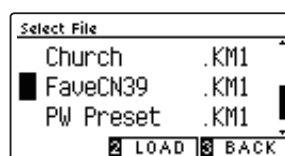

3. Confirming the load operation

Press the **[1]** FUNCTION button (YES) to confirm the load operation, or the **[3]** FUNCTION button (NO) to cancel.



4. Exiting the Load Startup Setting function

Press the **[3]** FUNCTION button (BACK) to exit the Load Startup Setting function and return to the Function Menus screen.

5 Save Internal Song

The Save Internal Song function is used to save CN39 recorder songs stored in the instrument's internal memory to a USB memory device in Kawai's native song format.

* Songs saved in the native Kawai song format can be later reloaded into the instrument's internal recorder memory.

* For more information about the instrument's 'Internal Song Recorder' feature, please refer to page 50.

1. Selecting the Save Song function

After entering the USB Menu (page 114):

Press the ▼ or ▲ buttons to select the Save Song function.

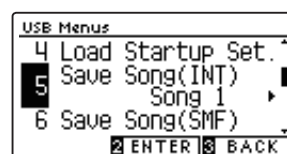

2. Selecting the song memory to be saved

Press the ◀ or ▶ buttons to select the internal song memory to be saved.

* If a song memory contains song data, a * symbol will be shown.

Press the [2] FUNCTION button (ENTER).

The filename input screen will be shown in the LCD display.



Song has been recorded

3. Naming the song

Press the ▼ or ▲ buttons to cycle through the alphanumeric characters, and the ◀ or ▶ buttons to move the cursor.

Press the [2] FUNCTION button (SAVE) to save the song, or the [3] FUNCTION button (BACK) to cancel.

A confirmation message will be shown in the LCD display, prompting to confirm or cancel the save operation.



4. Confirming the save operation

Press the [1] FUNCTION button (YES) to confirm the save operation, or the [3] FUNCTION button (NO) to cancel.

* The song file will be saved in the root folder of the USB memory device. It is not possible to save the file in a different folder.



5. Exiting the Save Song function

Press the [3] FUNCTION button (BACK) to exit the Save Song function and return to the Function Menu screen.

6 Save SMF Song

The Save SMF Song function is used to save CN39 recorder songs stored in the instrument's internal memory to a USB memory device as a Standard MIDI File (SMF).

* Songs saved in SMF format cannot be later reloaded into the instrument's internal recorder memory, however MIDI song files stored on a USB memory device can be edited using the 16 track recorder function.

* For more information about the instrument's 'Internal Song Recorder' feature, please refer to page 50. For more information about the instrument's 16 track recorder, please refer to page 60.

1. Selecting the Save SMF Song function

After entering the USB Menu (page 114):

Press the ▼ or ▲ buttons to select the Save SMF Song function.

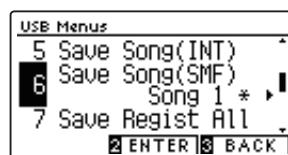

2. Selecting the song memory to be saved

Press the ◀ or ▶ buttons to select the internal song memory to be saved.

* If a song memory contains song data, a * symbol will be shown.

Press the [2] FUNCTION button (ENTER).

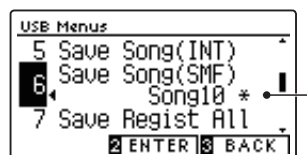

Song has been recorded

The filename input screen will be shown in the LCD display.

3. Naming the SMF song

Press the ▼ or ▲ buttons to cycle through the alphanumeric characters, and the ◀ or ▶ buttons to move the cursor.

Press the [2] FUNCTION button (SAVE) to save the song, or the [3] FUNCTION button (BACK) to cancel.



A confirmation message will be shown in the LCD display, prompting to confirm or cancel the save operation.

4. Confirming the save operation

Press the [1] FUNCTION button (YES) to confirm the save operation, or the [3] FUNCTION button (NO) to cancel.

* The SMF song file will be saved in the root folder of the USB memory device. It is not possible to save the file in a different folder.



5. Exiting the Save SMF Song function

Press the [3] FUNCTION button (BACK) to exit the Save SMF Song function and return to the Function Menu screen.

7 Save Registration All

The Save Registration All function is used to save a file containing all CN39 registration memories stored in the instrument to a USB memory device.

* For more information about the instrument's 'Registration' feature, please refer to page 34.

1. Selecting the Save Registration All function

After entering the USB Menu (page 114):

Press the ▼ or ▲ buttons to select the Save Registration All function.

Press the [2] FUNCTION button (ENTER).

The filename input screen will be shown in the LCD display.



2. Naming the Registrations file

Press the ▼ or ▲ buttons to cycle through the alphanumeric characters, and the ◀ or ▶ buttons to move the cursor.

Press the [2] FUNCTION button (SAVE) to save the registration file, or the [3] FUNCTION button (BACK) to cancel.

A confirmation message will be shown in the LCD display, prompting to confirm or cancel the save operation.



3. Confirming the save operation

Press the [1] FUNCTION button (YES) to confirm the save operation, or the [3] FUNCTION button (NO) to cancel.

* The registration file will be saved in the root folder of the USB memory device. It is not possible to save the file in a different folder.

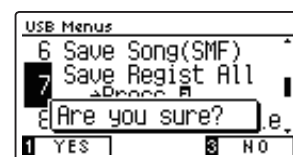

4. Exiting the Save Registration All function

Press the [3] FUNCTION button (BACK) to exit the Save Registration All function and return to the Function Menu screen.

8 Save Registration Single

The Save Registration Single function is used to save a single CN39 registration memory stored in the instrument to a USB memory device.

* For more information about the instrument's Registration feature, please refer to page 34.

1. Selecting the Save Registration Single function

After entering the USB Menu (page 114):

Press the ▼ or ▲ buttons to select the Save Registration Single function.



2. Selecting the registration memory to be saved

Press the ◀ or ▶ buttons to select the registration memory to be saved.

Press the [2] FUNCTION button (ENTER).

The filename input screen will be shown in the LCD display.



3. Naming the registration file

Press the ▼ or ▲ buttons to cycle through the alphanumeric characters, and the ◀ or ▶ buttons to move the cursor.

Press the [2] FUNCTION button (SAVE) to save the registration memory, or the [3] FUNCTION button (BACK) to cancel.

A confirmation message will be shown in the LCD display, prompting to confirm or cancel the save operation.



4. Confirming the save operation

Press the [1] FUNCTION button (YES) to confirm the save operation, or the [3] FUNCTION button (NO) to cancel.

* The registration file will be saved in the root folder of the USB memory device. It is not possible to save the file in a different folder.

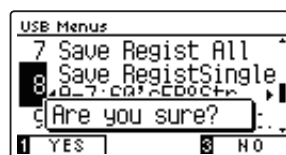

5. Exiting the Save Registration Single function

Press the [3] FUNCTION button (BACK) to exit the Save Registration Single function and return to the Function Menu screen.

9 Save Startup Setting

The Save Startup Setting function is used to save the current CN39 Startup Settings to a USB memory device.

* For more information about the instrument's 'Startup Setting' feature, please refer to page 79.

1. Selecting the Save Startup Setting function

After entering the USB Menu (page 114):

Press the ▼ or ▲ buttons to select the Save Startup Setting function.

Press the [2] FUNCTION button (ENTER).

The filename input screen will be shown in the LCD display.



2. Naming the Startup Setting file

Press the ▼ or ▲ buttons to cycle through the alphanumeric characters, and the ◀ or ▶ buttons to move the cursor.

Press the [2] FUNCTION button (SAVE) to save the startup settings file, or the [3] FUNCTION button (BACK) to cancel.

A confirmation message will be shown in the LCD display, prompting to confirm or cancel the save operation.



3. Confirming the save operation

Press the [1] FUNCTION button (YES) to confirm the save operation, or the [3] FUNCTION button (NO) to cancel.

* The startup settings file will be saved in the root folder of the USB memory device. It is not possible to save the file in a different folder.



4. Exiting the Save Startup Setting function

Press the [3] FUNCTION button (BACK) to exit the Save Startup Setting function and return to the Function Menu screen.

10 Rename File

The Rename File function is used to rename song, audio, and registration files stored on a USB memory device.

1. Selecting the Rename File function

After entering the USB Menu (page 114):

Press the ▼ or ▲ buttons to select the Rename File function.

Press the **[2]** FUNCTION button (ENTER).

The file selection screen will be shown in the LCD display, listing files stored on the USB memory device.



2. Selecting the file to be renamed

Press the ▼ or ▲ buttons to move the selection cursor, then press the **[2]** FUNCTION button (RENAME) to select the file to be renamed.

The filename input screen will be shown in the LCD display.

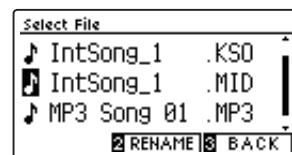

3. Renaming the selected file

Press the ▼ or ▲ buttons to cycle through the alphanumeric characters, and the ◀ or ▶ buttons to move the cursor.

Press the **[2]** FUNCTION button (RENAME) to rename the file, or the **[3]** FUNCTION button (BACK) to cancel.

A confirmation message will be shown in the LCD display, prompting to confirm or cancel the rename operation.



4. Confirming the rename operation

Press the **[1]** FUNCTION button (YES) to confirm the rename operation, or the **[3]** FUNCTION button (NO) to cancel.

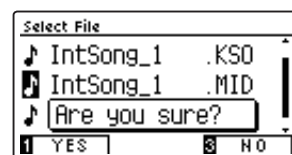

5. Exiting the Rename File function

Press the **[3]** FUNCTION button (BACK) to exit the Rename File function and return to the Function Menus screen.

11 Delete File

The Delete File function is used to delete song, audio, and registration files stored on a USB memory device. Once a file has been deleted from the USB device it cannot be recovered.

1. Selecting the Delete File function

After entering the USB Menu (page 114):

Press the ▼ or ▲ buttons to select the Delete File function.

Press the **[2]** FUNCTION button (ENTER).

The file selection screen will be shown in the LCD display, listing files stored on the USB memory device.

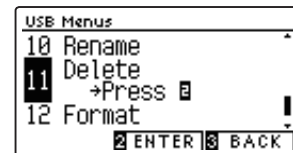

2. Selecting the file to be deleted

Press the ▼ or ▲ buttons to move the selection cursor, then press the **[2]** FUNCTION button (OK) to delete the file.

A confirmation message will be shown in the LCD display, prompting to confirm or cancel the delete operation.

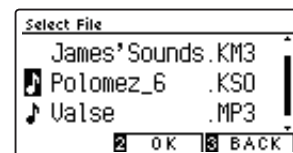

3. Confirming the delete operation

Press the **[1]** FUNCTION button (YES) to confirm the delete operation, or the **[3]** FUNCTION button (NO) to cancel.

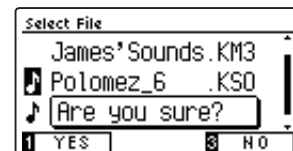

4. Exiting the Delete File function

Press the **[3]** FUNCTION button (BACK) to exit the Delete File function and return to the Function Menus screen.

12 Format USB

The Format USB function is used to format the connected USB memory device, erasing all stored data.



The USB Format function will erase all data stored on the connected USB memory device. Exercise caution when using this function in order to prevent accidental data loss.

1. Selecting the Format USB function

After entering the USB Menu (page 114):

Press the ▼ or ▲ buttons to select the Format USB function.

Press the **[2]** FUNCTION button (ENTER).

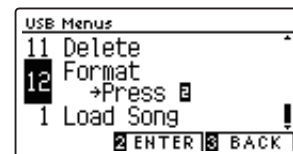

A confirmation message will be shown in the LCD display, prompting to confirm or cancel the format operation.

2. Confirming the format operation

Press the **[1]** FUNCTION button (YES) to confirm the format operation, or the **[3]** FUNCTION button (NO) to cancel.



3. Exiting the Format USB function

Press the **[3]** FUNCTION button (BACK) to exit the Format USB function and return to the Function Menu screen.

Bluetooth Settings

The Bluetooth Settings menu contains settings to enable/disable Bluetooth MIDI and Bluetooth Audio, and adjust the volume of the Bluetooth Audio input.

* Availability of Bluetooth MIDI function dependent on market location.

Bluetooth Settings

No.	Setting	Description	Default setting
1	Bluetooth Audio	Enable/disable the instrument's Bluetooth Audio function.	On
2	Bluetooth Audio Volume	Adjust the volume of Bluetooth Audio input.	0
3	Bluetooth MIDI	Enable/disable the instrument's Bluetooth MIDI function.	On

* Default settings will be shown in the first LCD display illustration (i.e. Step 1) for each setting explanation below.

Entering the Bluetooth Settings menu

While the normal playing mode screen is shown in the LCD display:

Press the **2** FUNCTION button (MENU).

The Function menus will be shown in the LCD display.

Press the **▼** or **▲** buttons to select the Bluetooth Settings menu.

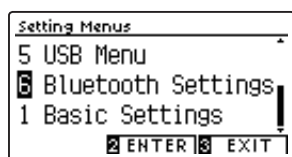

Press the **2** FUNCTION button (ENTER) again to enter the Bluetooth Settings menu.

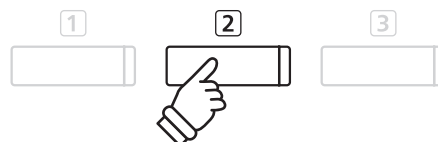
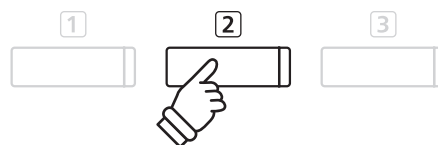

Selecting and adjusting the desired setting

After entering the Basic Settings menu:

Press the **▼** or **▲** buttons to move the selection cursor over the desired setting.

Press the **◀** or **▶** buttons to adjust the selected setting.

* To reset the current setting to the default value, press the **◀** and **▶** buttons simultaneously.

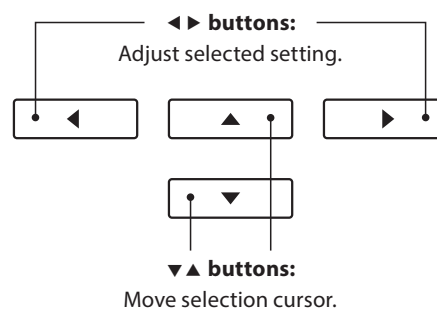

1 Bluetooth Audio

The Bluetooth Audio setting is used to enable/disable the CN39 digital piano's Bluetooth Audio function. When enabled, the CN39 digital piano can be connected to smart phones, tablets, and other smart devices to facilitate wireless audio communication, allowing music stored on a device to be played through the instrument's speaker system/headphones.

* This setting will be stored automatically, and recalled every time the instrument is turned on.

■ Bluetooth Audio setting

Bluetooth Audio	Description
Off	The instrument's Bluetooth Audio function will be turned off.
On (default)	The instrument's Bluetooth Audio function will be turned on.

1. Selecting the Bluetooth Audio setting

After entering the Bluetooth Settings menu (page 127):

Press the ▼ or ▲ buttons to select the Bluetooth Audio setting.



2. Changing the Bluetooth Audio setting

Press the ◀ or ▶ buttons to turn the Bluetooth Audio setting on or off.

* To reset the Bluetooth Audio setting to the default setting, press the ◀ and ▶ buttons simultaneously.

* The Bluetooth Audio setting will be stored automatically, and recalled every time the instrument is turned on.



3. Exiting the Bluetooth Audio setting

Press the [FUNCTION] button (BACK) to exit the Bluetooth Audio setting and return to the Function Menus screen.

■ Connecting the CN39 digital piano to a smart device using Bluetooth Audio

After enabling the Bluetooth Audio function of the CN39 digital piano, enable Bluetooth communications on the smart device. After a few seconds 'CN39 Audio' should appear in the smart device's Bluetooth settings device list. Tap the 'CN39 Audio' entry to connect the instrument to the smart device. It should now be possible for audio produced by the smart device to be heard through the instrument's speaker system/headphones.

* If loss of audio/connectivity or noise occurs, please check for Bluetooth Audio compatibility with the smart device manufacturer.

* For a list of potential issues and recommended solutions when using Bluetooth communications, please refer to page 138 of this owner's manual.

* The Auto Power Off setting will still be observed when playing audio via Bluetooth Audio.

2 Bluetooth Audio Volume

The Bluetooth Audio Volume setting is used to increase or decrease the volume level of Bluetooth Audio playback. While it's generally preferable to adjust the audio volume level on the smart device itself, this setting may still be useful in certain situations.

* This setting will be stored automatically, and recalled every time the instrument is turned on.

1. Selecting the Bluetooth Audio Volume setting

After entering the Bluetooth Settings menu (page 127):

Press the ▼ or ▲ buttons to select the Bluetooth Audio Volume setting.



2. Adjusting the volume setting of the Bluetooth Audio Volume

Press the ◀ or ▶ buttons to increase or decrease the level of the Bluetooth Audio Volume setting.

* The Bluetooth Audio Volume setting can be adjusted within the range of -15~+16.

* To reset the Bluetooth Audio Volume setting to the default value, press the ◀ and ▶ buttons simultaneously.

* Increasing the Bluetooth Audio Volume setting above normal levels may result in distortion or reduced audio quality.

* The Bluetooth Audio Volume setting will be stored automatically, and recalled every time the instrument is turned on.



3. Exiting the Bluetooth Audio Volume setting

Press the [3] FUNCTION button (BACK) to exit the Bluetooth Audio Volume setting and return to the Function Menus screen.

3 Bluetooth MIDI

The Bluetooth MIDI setting is used to enable/disable the CN39 digital piano's Bluetooth MIDI function. When enabled, the CN39 digital piano can be connected to smart phones, tablets, and other smart devices to facilitate wireless MIDI communication, allowing a wide range of music-related apps to be enjoyed using the instrument.

* This setting will be stored automatically, and recalled every time the instrument is turned on.

■ Bluetooth MIDI setting

Bluetooth MIDI	Description
Off	The instrument's Bluetooth MIDI function will be turned off.
On (default)	The instrument's Bluetooth MIDI function will be turned on.

1. Selecting the Bluetooth MIDI setting

After entering the Bluetooth Settings menu (page 127):

Press the ▼ or ▲ buttons to select the Bluetooth MIDI setting.



2. Changing the Bluetooth MIDI setting

Press the ◀ or ▶ buttons to turn the Bluetooth MIDI setting on or off.

* To reset the Bluetooth MIDI setting to the default setting, press the ◀ and ▶ buttons simultaneously.

* The Bluetooth MIDI setting will be stored automatically, and recalled every time the instrument is turned on.



3. Exiting the Bluetooth MIDI setting

Press the [3] FUNCTION button (BACK) to exit the Bluetooth MIDI setting and return to the Function Menus screen.

■ Connecting the CN39 digital piano to a smart device using Bluetooth MIDI

After enabling the Bluetooth MIDI function of the CN39 digital piano, enable Bluetooth communications on the smart device, then open the desired MIDI app. After a few seconds 'CN39' should appear in the app's device list. Tap the 'CN39' entry to connect the instrument to the smart device. It should now be possible for MIDI apps to communicate wirelessly with the CN39 digital piano.

* When the CN39 digital piano is connected to a smart device via Bluetooth MIDI, the USB MIDI and MIDI IN/OUT connectors will be disabled.

* Please check for Bluetooth MIDI compatibility with the smart device manufacturer and app developer.

* For a list of potential issues and recommended solutions when using Bluetooth communications, please refer to page 138 of this owner's manual.

* For more detailed instructions regarding Bluetooth pairing, please refer to the supplementary Bluetooth® Connectivity Guide manual, available from the Kawai Global website: <http://www.kawai-global.com/support/manual>

Assembly Instructions



Please read these assembly instructions thoroughly before attempting to assemble the CN39 digital piano. Please ensure that two or more people work on assembling the CN39 digital piano, especially when lifting the main body of the instrument onto the stand.

■ Included parts

Before attempting to assemble the CN39 digital piano, ensure that all parts below are included. A Phillips-head screwdriver (not included) will also be required in order to assemble the instrument.

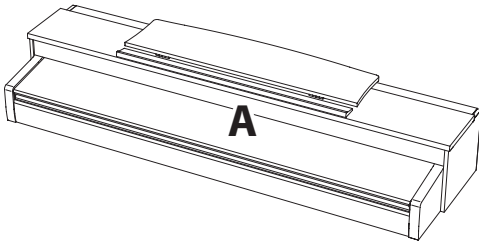

Main body

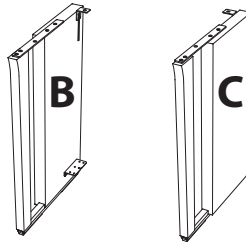

Side panels (left & right)

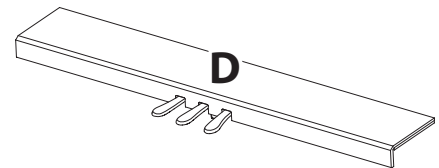

Pedal board
(including adjustor bolt)

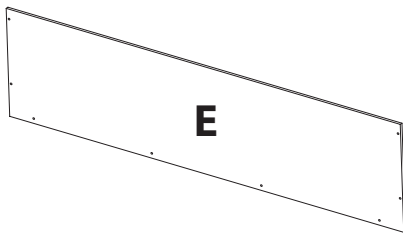

Back board

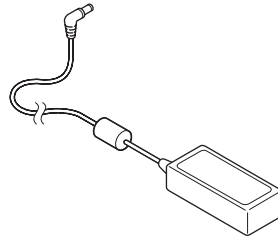

AC/DC adaptor



Power cable

Screw set

- a** Screw (with washer) x 4



- b** Tapping screw (black, 30 mm) x 4



- c** Tapping screw (black, 20 mm) x 4



- d** Tapping screw (silver, 16 mm) x 4



* For Satin White finished instruments, black screws will be replaced with silver screws.

* The **d** tapping screws are provided in a separate bag.

Headphone hook set

Headphone hook



Mounting screws (14 mm) x 2



Assembly Instructions

1. Attaching the side panels to the pedal board

- 1 Unfasten and extend the pedal connection cable attached to the bottom of the pedal board (D).
- 2 Attach the pedal board (D) to the left (B) and right (C) side panels using the temporary mounting screws located on either end of the pedal board.
- 3 Ensure that the pedal board and side panels make close contact, and that there are no large gaps between the assembled parts.
- 4 Insert the four short silver tapping screws **Ⓒ** into the holes as shown, and securely fasten the pedal board to the left and right side panels.

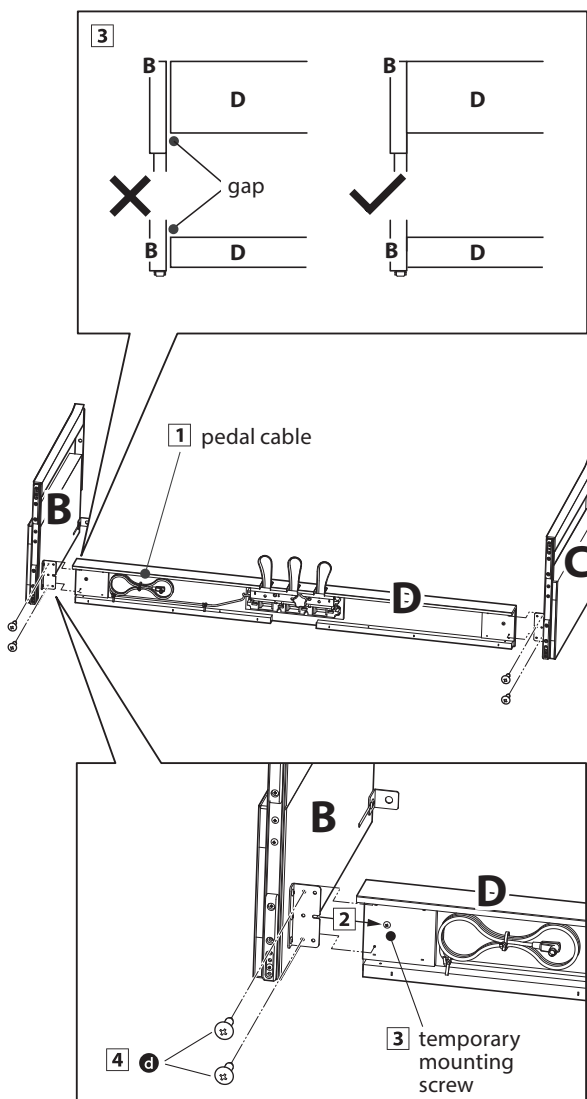

2. Attaching the back board

- 1 Allow the assembled pedal board and side panels to stand upright (vertically) on the floor.
 - * Ensure that the adjustor bolt is attached to the pedal board.
- 2 Loosely attach the back board (E) to the left and right side panels using the four long black tapping screws **Ⓐ**.
- 3 Loosely attach the back board to the pedal board using the four mid-length black tapping screws **Ⓒ**.
- 4 Adjust the positioning of the pedal board, side panels, and backboard to ensure that all parts are in alignment, then tighten the screws in steps 2 and 4.

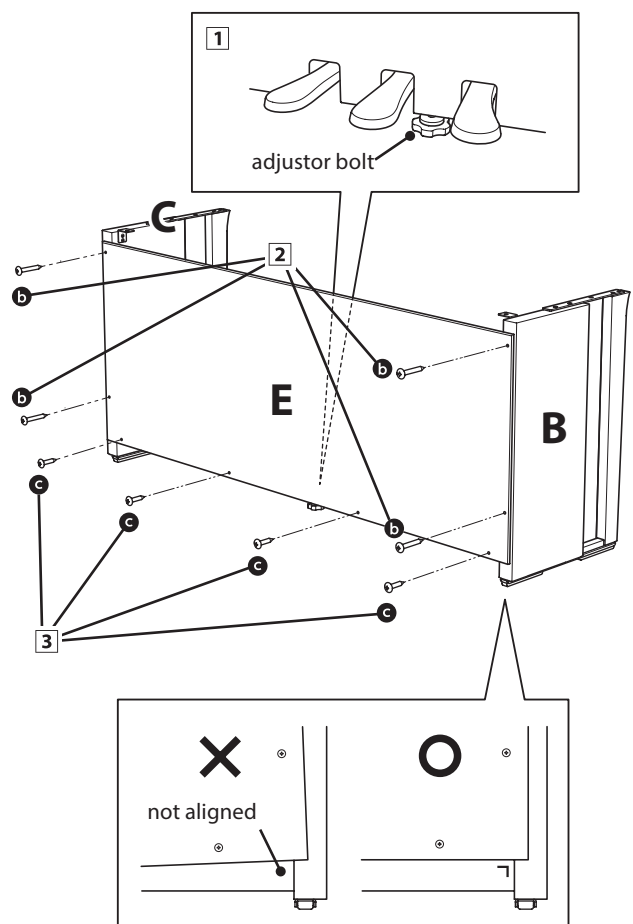

3. Mounting the main body onto the stand



Ensure that two or more people undertake the following step of the assembly process.

- 1 Lift the main body (A) and carefully place it onto the stand. Position the main body towards the front of the stand, so that the metal fitting holes are visible when viewed from above.
- 2 Gently slide the main body backwards until the base engages with the stand fixings and locks into place. When positioned correctly, the attachment screw holes should be visible from the underside of the main unit.

* If the screw holes are not visible, re-adjust (loosen) the screws attached in step 2-4.



When lifting the main body onto the stand, be careful not to catch/trap hands and fingers.

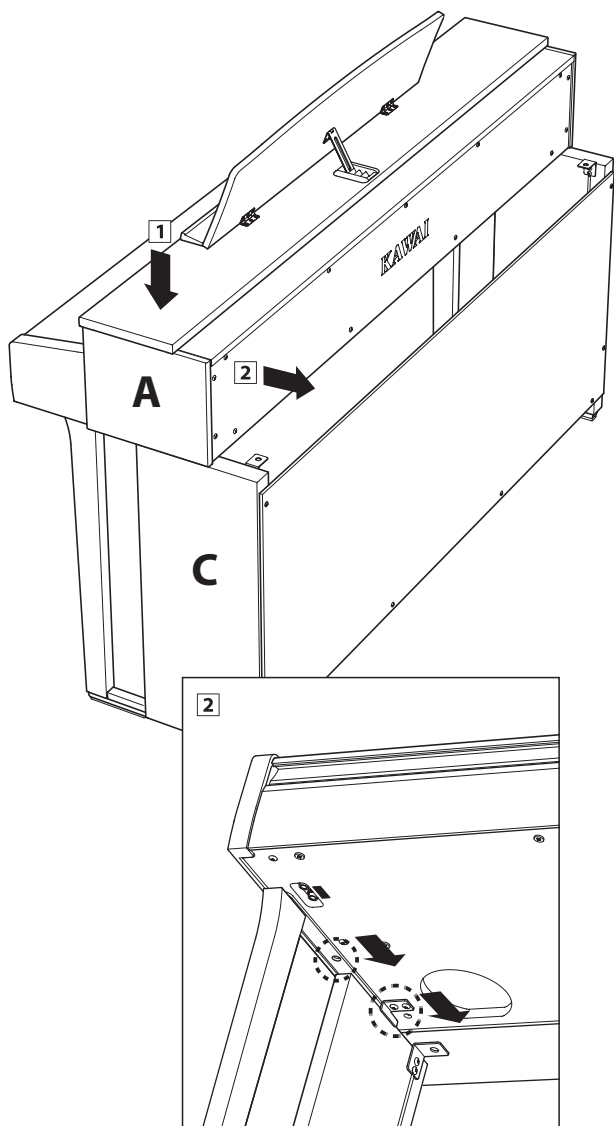

4. Fastening the main body to the stand

- 1 View the front of the instrument to ensure that the main body and side panels are in alignment.
* If the parts are not in alignment, re-adjust (loosen) the screws attached in step 2-4.
- 2 Loosely fasten the front of the main body to the stand from below, using two screws (with washer) (a) on either side.
- 3 Loosely fasten the rear of the main body to the stand from below, using the remaining two screws (with washer) (a) on either side.
- 4 When all four screws are attached and the main body is correctly positioned on top of the stand, securely tighten all screws.



Tighten all screws securely to ensure that the main body is firmly attached to the stand.

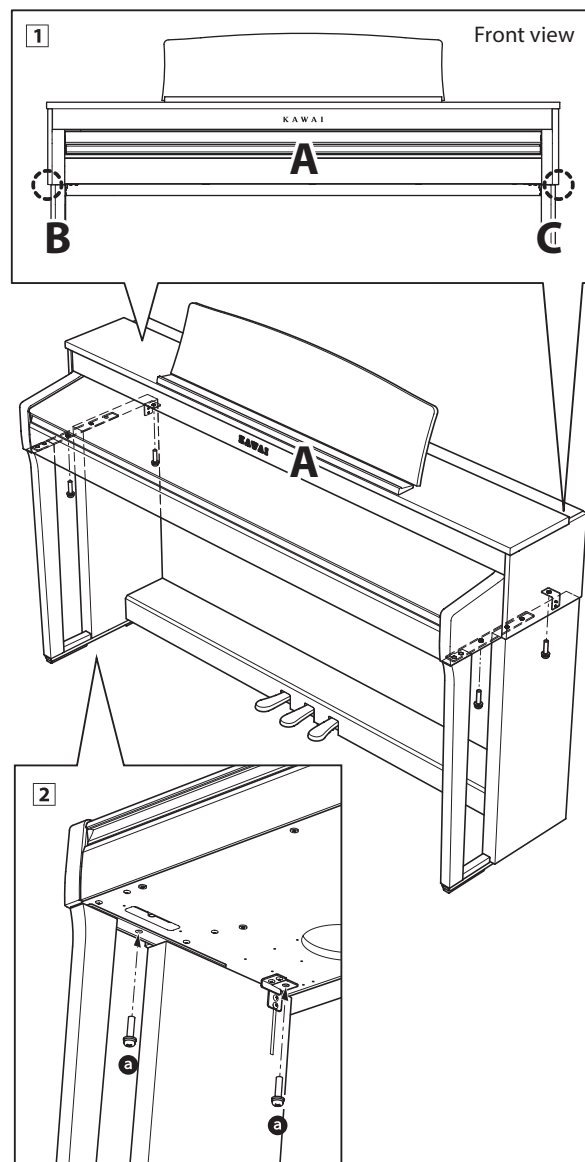

Assembly Instructions

5. Connecting the power adaptor & pedal cables

- 1 Connect the AC/DC power adaptor to the DC IN terminal on the underside of the main body, then pass the cable through the back board aperture, and out to the rear of the instrument.
- 2 Pass the pedal cable (extending from the rear of the pedal board) through the aperture to the front of the main body, and connect to the PEDAL terminal.
- 3 With the power adaptor and pedal cables connected, use the binders to fix the cables in place and tidy their appearance.

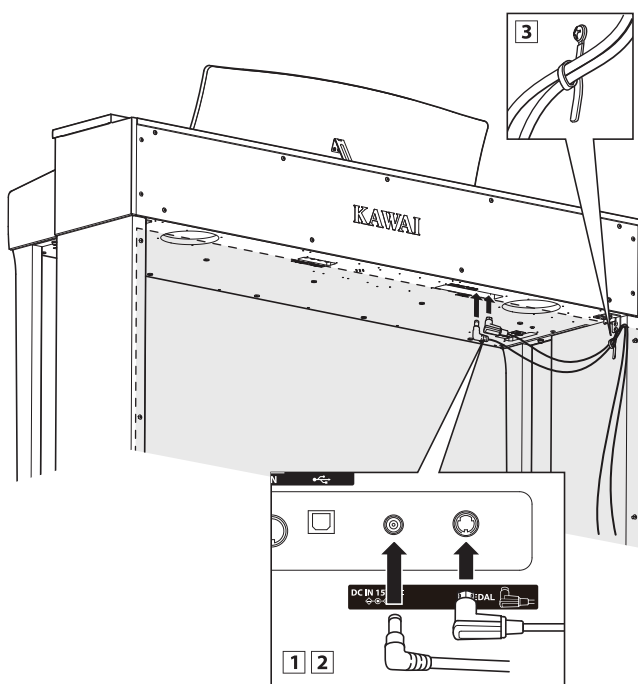

To avoid damaging the plugs or bending the pins, connect the plugs with the correct orientation, and do not apply excessive force when connecting.

6. Attaching the headphone hook (optional)

A headphone hook is included with the CN39 digital piano and can be used to hang headphones when not in use.

- 1 If desired, attach the headphone hook to the underside of the main body using the two tapping screws provided.

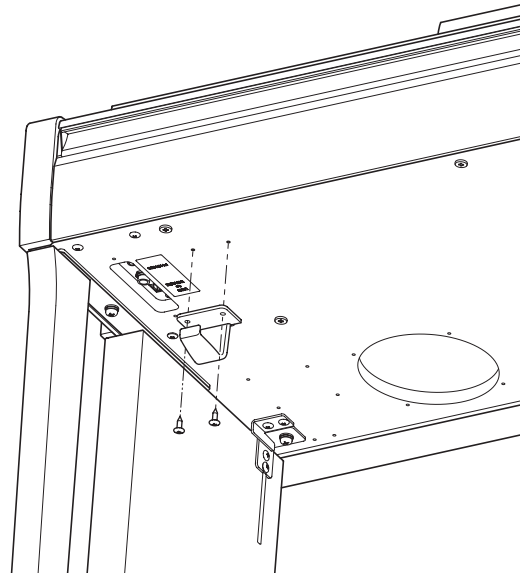

7. Adjusting the pedal support bolt

- 1 Turn the pedal support bolt anti-clockwise, extending the bolt until it makes contact with the floor and supports the pedals firmly.

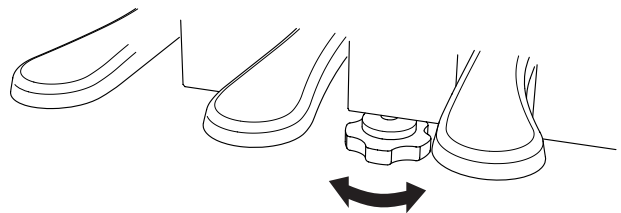

When moving the instrument, always adjust or remove the pedal support bolt, then readjust when the instrument is in its new position.

Connecting to Other Devices

The CN39 digital piano features a variety of jacks that allow the instrument to be connected to MIDI devices, computers, speakers, and mixers. It is also possible to connect external audio sources, such as an MP3 player, tablet, or a secondary keyboard, to the instrument's amplifier and speaker system. The illustration below provides a visual overview of the connectors and their typical applications.

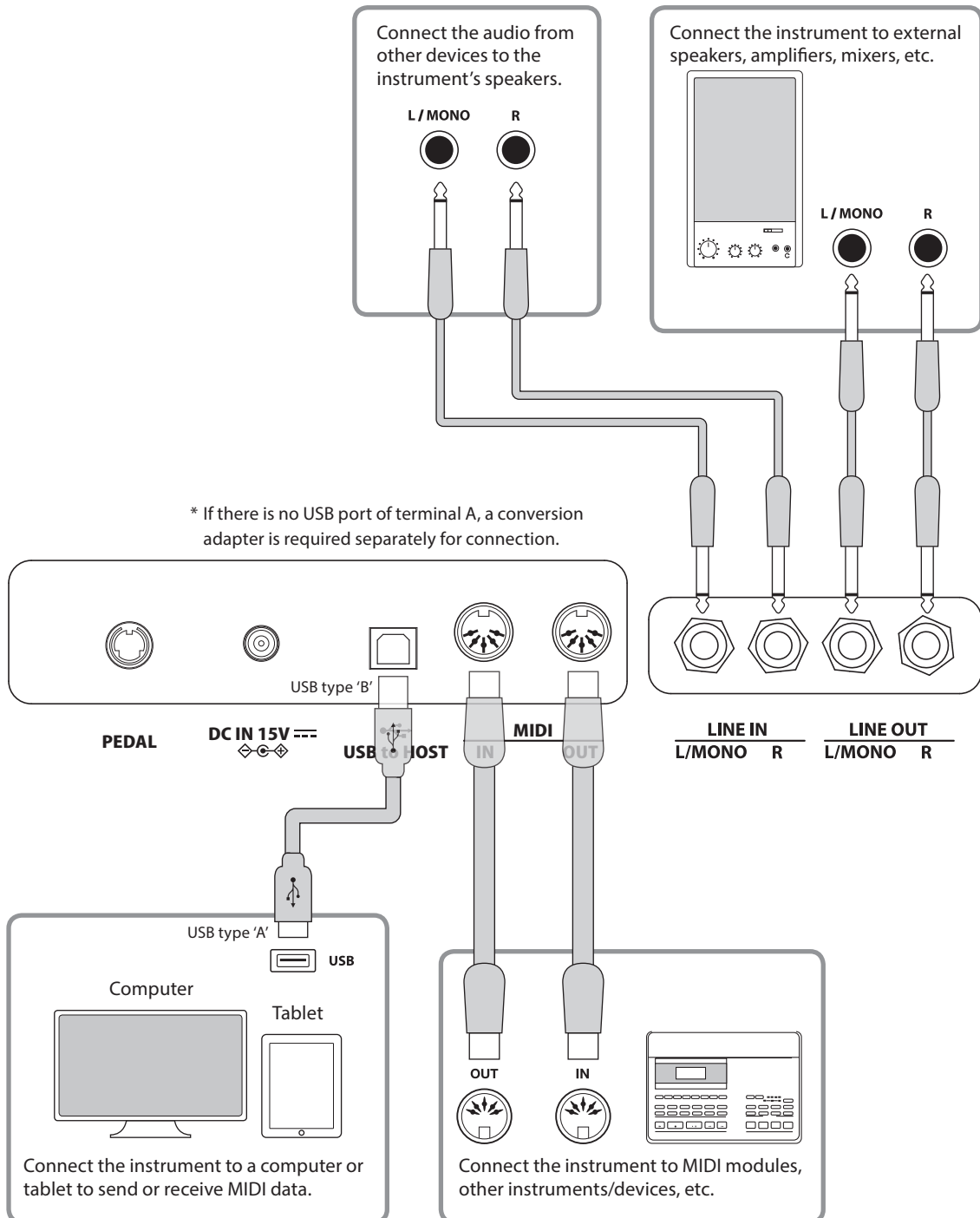

Before connecting the CN39 digital piano to other devices, ensure that the power to both the instrument and the other device is turned off. If connections are established while the power is turned on, extraneous noise that can damage the CN39 digital piano may activate the instrument's amplifier protection circuit, preventing any sound from being produced. If this occurs, turn the power off and then on again to reset the amplifier protection circuit.

Do not connect the LINE IN and LINE OUT jacks of the CN39 digital piano together with the same cable. An audio loop (oscillation sound) will occur, resulting in damage to the unit.

Jack Panel

■ LINE IN jacks (1/4" phone jacks)

These jacks are used to connect a pair of stereo outputs from other electronic instruments or audio equipment to the CN39 digital piano's speakers. To adjust the LINE IN level, please use the volume controls on the device itself.

To connect a device in mono, connect the cable to the L/MONO jack only.

■ USB to Host port ('B' type)

This USB port is used to connect the CN39 digital piano to a computer using an inexpensive USB cable. When connected, the instrument can be used as a standard MIDI device, allowing it to send a receive MIDI data. Connect a 'B' type USB connector to the instrument, and an 'A' type USB connector to the computer.

* Please refer to page 113 for more information about USB MIDI.

With additional conversion adaptors, this port may also be used to connect the CN39 digital piano to tablets and other mobile devices.

■ LINE OUT jacks (1/4" phone jacks)

These jacks are used to connect the stereo output of the CN39 digital piano's sound to external speakers, amplifiers, mixers, recording devices, and similar equipment.

To output a mono signal, connect a single cable to the L/MONO jack.

The LINE OUT level can be adjusted using the MASTER VOLUME slider.

■ MIDI IN/OUT jacks

These jacks are used to connect the CN39 digital piano to external MIDI devices, or to a computer (using a USB-MIDI interface) as an alternative to the 'USB to Host' port.

* Please refer to page 1 of the "CN39 MIDI Settings Manual" for more information about MIDI.

* When the CN39 digital piano is connected to a smart device using Bluetooth MIDI, the MIDI IN/OUT jacks and USB to Host port will be disabled.

Headphone Panel

■ PHONES jacks (1/4" & 1/8" phone jacks)

These jacks are used to connect stereo headphones to the CN39 digital piano. Two pairs of headphones can be connected and used simultaneously. When a pair of headphones is connected, sound will not be produced by the speakers.

■ USB device information

- The 'USB to Device' functionality of the CN39 digital piano conforms to USB2.0 Hi-Speed standards. Older USB devices can still be used, however data transfer speed will be limited to the maximum transfer speed of the device.
- The 'USB to Device' port is intended for connecting USB memory devices, however USB floppy drive devices can also be used to save recorder songs stored in internal memory, or play SMF song files.

■ USB to Device port ('A' type)

This USB port is used to connect a USB memory device to the CN39 digital piano. This allows MP3/WAV audio files, and SMF song files to be played directly. It is also possible to record performances to MP3/WAV audio files, and save recorder songs stored in internal memory for posterity.

- It may be necessary to format the USB memory device before it can be used with the CN39 digital piano. If so, please refer to the USB Format function instructions on page 126. Formatting the device will erase all data.
- Avoid removing the USB memory device while data is being loaded or saved, files are being renamed or deleted, or the device is being formatted.
- Other USB devices, such as computer mice, keyboards, or battery chargers etc. cannot be used with this instrument.

Troubleshooting

The tables below summarise issues that may be experienced with the CN39 digital piano, explaining the typical cause(s), and recommended solution(s).

■ Power

Issue	Possible Cause and Solution	Page no.
<i>The instrument does not turn on.</i>	Check that the power cable is firmly attached to the instrument, and connected to an AC outlet.	p. 14
<i>The instrument turns itself off after a period of inactivity.</i>	Check that the 'Auto Power Off' function is not enabled.	p. 81

■ Sound

Issue	Possible Cause and Solution	Page no.
<i>The instrument is turned on, however no sound is produced when the keys are pressed.</i>	Check that the MASTER VOLUME slider is not set to the lowest position.	p. 16
	Check that a pair of headphones (or headphone adaptor plug) are not connected to the PHONES jacks.	p. 16
	Check that the 'Local Control' setting in the MIDI Settings menu is set to On.	MIDI Settings Manual p. 5
<i>The sound distorts when playing at very loud volume levels.</i>	Check that the MASTER VOLUME slider is set to an appropriate level, reducing the volume if excessive distortion is heard. If connecting the instrument to an amplifier/mixer using the Line Out jacks, reduce the value of the 'Line Out Volume' setting in the Basic Settings menu	p. 16
<i>Strange sounds or noises are heard when playing with piano sounds.</i>	The CN39 digital piano attempts to reproduce the rich variety of tones created by an acoustic grand piano as accurately as possible. This includes various resonances, noises, and other subtle characteristics that contribute to the overall piano playing experience. While these additional tones are intended to enhance the realism of the instrument, it is possible to reduce their prominence, or disable the effects altogether using the settings in the Virtual Technician menu.	p. 83
<i>The top 18 notes of the keyboard sustain for longer than neighbouring notes, even when the damper pedal is not pressed.</i>	This is the correct behaviour, and intended to reproduce the undamped notes (typically the top two octaves) of an acoustic grand piano.	–

■ Pedals

Issue	Possible Cause and Solution	Page no.
<i>The pedals are unreliable or do not function at all.</i>	Check that the pedal cable is firmly connected to the instrument.	p. 134
<i>When depressing a pedal, the pedal board flexes and is not firm.</i>	Check that the pedal support bolt is fully extended.	p. 134

■ Headphones

Issue	Possible Cause and Solution	Page no.
<i>The headphone volume is too low.</i>	If the 'Nominal Impedance' specification of the headphones is less than 100 Ω (ohms), set the 'Phones Volume' setting in the Phones Settings menu to High.	p. 112
<i>The headphone output sounds strange.</i>	Check that the 'SHS Mode' and 'Phones Type' settings are set to 'Normal'.	p. 110 p. 111

Troubleshooting

■ USB (memory device)

Issue	Possible Cause and Solution	Page no.
<i>A USB memory device is not detected, cannot be saved to, or does not appear to function when connected to the 'USB to Device' port.</i>	Check that the USB memory device is formatted to use the FAT/FAT32 filesystem, and not set to 'Write Protect' mode.	p. 136
	Disconnect the USB memory device, turn the instrument off then on, then reconnect the USB device. If the USB device still does not function, it may be damaged or incompatible. Please try using a different USB device.	–
<i>The instrument pauses briefly when connecting a USB memory device.</i>	This is recognised behaviour when using large capacity (e.g. 8GB+) USB memory devices.	–

■ USB MIDI, MIDI, Bluetooth® MIDI

Issue	Possible Cause and Solution	Page no.
<i>The instrument is connected to the computer using a USB cable (or a USB-MIDI adaptor), however the software does not respond to key presses.</i>	Check that a USB MIDI driver is installed on the computer.	p. 113
	Check that 'USB Audio Device' or 'KAWAI USB MIDI' is selected in the software's input/output device settings.	p. 113
	Check that the instrument is not connected to a smart device using Bluetooth MIDI.	p. 130
<i>The instrument cannot connect to the smart device/app via Bluetooth.</i>	Check that the instrument's Bluetooth Audio/MIDI function is turned On.	p. 130
	Ensure that the mobile device's Bluetooth function is turned On.	–
	Try deleting the instrument's Bluetooth connection using the mobile device's 'Forget Device' function.	–
	Try turning the instrument Off and then On, and/or restarting the mobile device.	–

■ MP3/WAV/SMF files

Issue	Possible Cause and Solution	Page no.
<i>No sound can be heard when playing an MP3 or WAV audio file stored on a USB memory device.</i>	Check that the audio player volume is not set to 0.	p. 59
	Check that the format of the audio file is supported and listed in the 'Audio Player supported format specifications' table.	p. 58
<i>An MP3/WAV audio file stored on a USB memory device sounds strange, or does not play back correctly.</i>	Check that the format of the audio file is supported and listed in the 'Audio Player supported format specifications' table.	p. 58
	The file transfer speed of the USB memory device may be too slow to play the audio file. Please try using a different USB memory device, ensuring that it conforms to USB2.0 Hi-Speed standards.	p. 136
<i>When recording MP3/WAV audio files, the volume is too low/too high (distorted).</i>	Check the gain setting before recording the audio, and if necessary adjust to increase/decrease the recording level.	p. 56

Demo Song List

Sound Name	Song Title	Composer
PIANO 1		
SK Concert Grand	La Campanella	Liszt
EX Concert Grand	Hungarian Rhapsodies No.6	Liszt
SK-5 Grand	Lieder Ohne Worte No.18 "Duetto"	Mendelssohn
Studio Grand	Original	Kawai
Studio Grand 2	Original	Kawai
Mellow Grand	Sonata No.30 Op.109	Beethoven
Mellow Grand 2	La Fille aux Cheveux de lin	Debussy
PIANO 2		
Upright Piano	Alpengluehen Op.193	Oesten
Standard Grand	Petit Chien	Chopin
Modern Piano	Original	Kawai
E. PIANO		
Classic E.Piano	Original	Kawai
Modern E.P.	Original	Kawai
Modern E.P. 2	Original	Kawai
ORGAN		
Jazz Organ	Original	Kawai
Blues Organ	Original	Kawai
Church Organ	Chorale Prelude "Wachet auf, ruft uns die Stimme."	Bach
HARPSI & MALLETS		
Harpsichord	French Suite No.6	Bach
Vibraphone	Original	Kawai
Clavi	Original	Kawai
STRINGS & CHOIR		
Slow Strings	Original	Kawai
String Pad	Original	Kawai
String Ensemble	Le quattro stagioni: la "Primavera"	Vivaldi
Choir	Londonderry Air	Irish folk song
Choir 2	Original	Kawai
New Age Pad	Original	Kawai
Atmosphere	Original	Kawai
BASS		
Wood Bass	Original	Kawai
Electric Bass	Original	Kawai
Fretless Bass	Original	Kawai
W. Bass & Ride	Original	Kawai
OTHERS		
	Zwei Rapsodien Op.79 Nr.2	Brahms
	Piano Concerto a moll Op.16	Grieg

Settings List

The tables below list all of the settings/functions that can be adjusted from the CN39 digital piano's panel interface, in addition to available ranges/types, default settings, and Registration/Startup Setting storing capabilities.

No.	Setting Name	Range / Type	Default Setting	Registration	Startup Setting
1. Basic Settings					
1	Key Transpose	-12 (C)~+12 (C)	0 (C)	●	●
2	Song Transpose	-12 (C)~+12 (C)	0	-	-
3	Tone Control	Flat, Brilliance, Bass Boost, Bass Cut, Mid Boost, Loudness, Bright, Mellow, User	Flat	●	●
	Brilliance	-10~+10	0	●	●
	User Low	-6~+6	0 dB	●	●
	User Mid-low Freq.	250 Hz~4000 Hz	560 Hz	●	●
	User Mid-low dB	-6~+6	0 dB	●	●
	User Mid-high Freq.	250 Hz~4000 Hz	1250 Hz	●	●
	User Mid-high dB	-6~+6	0 dB	●	●
	User High	-6~+6	0 dB	●	●
4	Speaker Volume	Normal, Low	Normal	-	●
5	Tuning	427.0 Hz~453.0 Hz	440.0 Hz	●	●
6	Damper Hold	Off, On	Off	●	●
7	Split	Off, On	Off	●	●
8	Four Hands	Off, On	Off	●	●
9	Startup Setting	n/a	-	-	-
10	Factory Reset	n/a	-	-	-
11	Auto Display Off	15 secs., 5 min., 30 min.	5 min.	-	-*
12	Auto Power Off	Off, 15 min., 60 min., 120 min.	-	-	-*
2. Virtual Technician					
1	Touch Curve	Light+, Light, Normal, Heavy, Heavy+, Off, User 1/2	Normal	●	●
2	Voicing	Normal, Mellow 1, Mellow 2, Dynamic, Bright 1, Bright 2, User 1~4	Normal	●	●
	User Voicing	-5~+5	-	-	●
3	Damper Resonance	Off, 1~10	5	●	●
4	Damper Noise	Off, 1~10	5	●	●
5	String Resonance	Off, 1~10	5	●	●
6	Undamped String Resonance	Off, 1~10	5	●	●
7	Cabinet Resonance	Off, 1~10	1	●	●
8	Key-off Effect	Off, 1~10	5	●	●
9	Fall-back Noise	Off, 1~10	5	●	●
10	Hammer Delay	Off, 1~10	Off	●	●
11	Topboard Simulation	Open3, Open2, Open1, Closed	Open 3	●	●
12	Decay Time	1~10	5	●	●
13	Minimum Touch	1~20	1	●	●
14	Stretch Tuning	Off, Normal, Wide, User 1~4	Normal	●	●
	User Tuning	-50~+50	-	-	●
15	Temperament	Equal, Pure Major, Pure Minor, Pythagorean, Meantime, Werckmeister, Kirnberger, User	Equal Temp.	●	●
	User Temperament	-50~+50	-	●	●
16	Temperament Key	C~B	C	●	●
17	Key Volume	Normal, High Damping, Low Damping, High & Low Damping, Center Damping, User 1~4	Normal	●	●
	User Key Volume	-50~+50	-	-	●
18	Half-Pedal Adjust	1~10	5	●	●
19	Soft Pedal Depth	1~10	3	●	●

No.	Setting Name	Range / Type	Default Setting	Registration	Startup Setting
3. Phones Settings					
1	SHS Mode	Off, Forward, Normal, Wide	Normal	-	●
2	Phones Type	Normal, Open, Semi-open, Closed, Inner-ear, Canal	Normal	-	●
3	Phones Volume	Normal, High	Normal	-	●
4. MIDI Settings					
1	MIDI Channel	1ch~16ch	1	●	●
2	Send PGM Change #	1~128	1	●	●
3	Local Control	Off, On	On	●	●
4	Trans. PGM Change	Off, On	On	●	●
5	Multi-timbral Mode	Off, On1, On2	Off	●	●
6	Channel Mute	Play, Mute (for each channel)	Play All	●	●
6. Bluetooth Settings					
1	Bluetooth Audio	Off, On	On	-	- *
2	Bluetooth Audio Volume	-15~+16	0	-	- *
3	Bluetooth MIDI	Off, On	On	-	- *
Dual Mode					
	Sound Combination	n/a	n/a	●	●
	Balance	1-9~9-1	9-9	●	●
	Layer Octave Shift	-2~+2	0	●	●
	Dynamics	Off, 1~10	10	●	●
Split Mode					
	Sound Combination	n/a	n/a	●	●
	Balance	1-9~9-1	9-9	●	●
	Lower Octave Shift	0~+3	0	●	●
	Lower Pedal	Off, On	Off	●	●
	Split Point	A0~C#8	C4	●	●
Four Hands Mode					
	Sound Combination	n/a	n/a	●	●
	Balance	1-9~9-1	9-9	●	●
	Right Octave Shift	-3~+0	-2	●	●
	Left Octave Shift	0~+3	+2	●	●
	Split Point	A0~C#8	F4	●	●
Reverb					
	Type	Room, Lounge, Small Hall, Concert Hall, Live Hall, Cathedral	Sound's default	●	●
	Depth	1~10	Sound's default	●	●
	Time	1~10	Sound's default	●	●
Effects					
	Type	See page 28	Sound's default	●	●
	Effect parameters	See page 28	Sound's default	●	●
Metronome					
	Tempo	10~400 bpm	120 bpm	●	●
	Beat	1/4, 2/4, 3/4, 4/4, 5/4, 3/8, 6/8, 7/8, 9/8, 12/8, 100 Drum Rhythms	4/4	●	●
	Volume	1~10	5	●	●
Internal Recorder					
	Key Transpose	-12 (C)~+12 (C)	0 (C)	-	-
	Song Transpose	-12 (C)~+12 (C)	0	-	-
USB Recorder					
	Play Mode	Single, 1-Repeat, All-Repeat, Random	Single	-	-
	Tempo	10~400 bpm	120 bpm	-	-
	Key Transpose	-12 (C)~+12 (C)	0	-	-
	Song Transpose	-12 (C)~+12 (C)	0	-	-
	Song Part	Play, Mute (for each channel)	Play All	-	-

* Stored to Startup Setting memory automatically.

Sound List

PIANO1

SK ConcertGrand

EX ConcertGrand

SK-5 GrandPiano

Studio Grand

Studio Grand 2

Mellow Grand

Mellow Grand 2

PIANO2

Upright Piano

Standard Grand

Pop Grand

Upright Piano_2

Modern Piano

Upright Piano 3

Honky Tonk

E.PIANO

Classic E.Piano

60's E.P.

Modern E.P.

Electric Grand

Classic E.P. 2

Classic E.P. 3

Modern E.P. 2

ORGAN

Jazz Organ

Blues Organ

Ballad Organ

Gospel Organ

Church Organ

Mellow Flutes

Medium Ensemble

Loud Ensemble

HARPSI & MALLETS

Harpsichord

Vibraphone

Clavi

Marimba

Celesta

Music Box OctUP

STRINGS & CHOIR

Slow Strings

String Pad

Warm Strings

String Ensemble

Choir

Choir 2

New Age

Atmosphere

BASS

Wood Bass

Electric Bass

Fretless Bass

W. Bass & Ride

OTHERS : PIANO

Jazz Grand

Studio Grand 3

Mellow Grand 3

Rock Piano

New Age Piano

New Age Piano 2

New Age Piano 3

Piano Octaves

Wide Honky Tonk

OTHERS : E.PIANO

Electric Grand2

Dolce E.P.

Crystal E.P.

Tremolo E.P.

Classic E.P. 4

Classic E.P. 5

New Age E.P.

Modern E.P. 3

Modern E.P. 4

Legend E.P.

Phase E.P.

OTHERS : HARPSI & MALLETS

Harpsichord 2

Harpsichord 3

Harpsichord Oct

WideHarpsichord

Synth Clavi

Glockenspiel

Music Box

Toy Piano

Wide Vibraphone

Wide Marimba

Xylophone

Handbells

Tubular Bells

Church Bells

Carillon

Dulcimer

OTHERS : DRAWBAR

Drawbar Organ

Drawbar Organ 2

Drawbar Organ 3

Drawbar Organ 4

Drawbar Organ 5
Drawbar Organ 6
Soft Solo
ElectronicOrgan
60's Organ
Perc. Organ
Tibia Bass
Rock Organ
OTHERS : CHURCHORGAN
Principal Oct.
Soft Diapason
Soft Strings
Bright Ensemble
Full Organ
Reed Ensemble
Diapason
Full Ensemble
Diapason Oct.
Theater Organ
8' Celeste
Small Ensemble
Reeds
Chiffy Tibia
Principal Pipe
Church Organ 2
Church Organ 3
Reed Organ
Puff Organ
OTHERS : ACCORDION
FrenchAccordion
Fr. Accordion 2
Accordion
Accordion 2
Blues Harmonica
Harmonica
Tango Accordion
OTHERS : GUITAR
FingerNylon Gtr
Nylon Acoustic
Nylon Acoustic2
Nylon Acoustic3
Ukulele
Ballad Guitar
Steel Guitar
Steel Guitar 2
12 String
Mandolin
Jazz Guitar
Pedal Steel

Rhythm Guitar
Electric Guitar
E. Guitar 2
E. Guitar 3
Muted Electric
Cutting Guitar
Country Lead
OverdriveGuitar
Dynmic Ov.drive
Distortion
Dist Feedback
Dist Rhythm
E.Gtr Harmonics
Guitar Feedback
OTHERS : BASS
Wood Bass 2
Wood Bass 3
Wood Bass 4
Electric Bass 2
Electric Bass 3
FingerSlap Bass
Pick Bass
Slap Bass
Slap Bass 2
Synth Bass
Synth Bass 2
Synth Bass 3
Synth Bass 4
Warm Synth Bass
Clavi Bass
Hammer Bass
Rubber Bass
Attack Bass
OTHERS : STRINGS&ORCHINST
Violin
Slow Violin
Viola
Cello
Contrabass
Tremolo Strings
Strings & Brass
60's Strings
Strings sf.
StringEnsemble2
Synth Strings
Synth Strings 2
Synth Strings 3
Pizzicato
Harp

Sound List

Celtic Harp

Timpani

OTHERS : CHOIR & HIT

Choir 3

Voice Oohs

Humming

DoReMi #

DoReMi b

Synth Vocal

Analog Voice

Orchestra Hit

Bass Hit Plus

6th Hit

Euro Hit

OTHERS : BRASS

Trumpet

Solo Trumpet

Flugel Horn

SentimentalBone

Trombone

Trombone 2

Bright Trombone

Tuba

CupMute Trumpet

CupMuteTrombone

Muted Trumpet

Muted Trumpet 2

French Horns

Warm FrenchHorn

Brass Section

Brass Section 2

Synth Brass

Synth Brass 2

Synth Brass 3

Synth Brass 4

Jump Brass

Analog Brass

Analog Brass 2

OTHERS : REED

Oboe & Strings

Soprano Sax

Alto Sax

Soft Tenor Sax

Tenor Sax

Baritone Sax

Oboe

English Horn

Bassoon

Clarinet

OTHERS : PIPE

Flute & Strings

Piccolo

Jazz Flute

Big Band Winds

OrchestralWinds

Flute

Ballad Flute

Recorder

Pan Flute

Blown Bottle

Shakuhachi

Whistle

Ocarina

OTHERS : SYNTH LEAD

Square

Square 2

Sine

Classic Synth

Classic Synth 2

Lead

Classic Synth 3

SequencedAnalog

Calioppe

Chiff

Charang

Wire Lead

Voice

Fifth

Bass & Lead

Soft Wire Lead

OTHERS : SYNTH PAD

Itopia

New Age 2

New Age 3

New Age 4

Warm Pad

Sine Pad

Bright Warm Pad

Polysynth

Choir Pad

Bowed Pad

Metallic Pad

Halo Pad

Sweep Pad

Multi Sweep

OTHERS : SYNTH SFX

Rain Pad

Soundtrack

Crystal
Synth Mallet
Brightness
Brightness 2
Goblin
Echoes
Echo Bell
Echo Pan
Sci-Fi
OTHERS : ETHNIC
Sitar
Sitar 2
Banjo
Shamisen
Koto
Taisho Koto
Kalimba
Bag Pipe
Fiddle
Shanai
OTHERS : PERCUSSION
Tinkle Bell
Agogo
Steel Drums
Woodblock
Castanet
Taiko Drums
Concert BD
Melodic Toms
Melodic Toms 2
Synth Drum
Rhythm Box Tom
Electric Drum
Reverse Cymbal
Gtr Fret Noise
GtrCuttingNoise
CuttingNoise 2
Ac Bass Slap
OTHERS : SFX
Breath Noise
Flute Key Click
Seashore
Rain
Thunder
Wind
Stream
Bubble
Bird Tweet
Dog Barking

Horse Gallop
Bird Tweet 2
Cat&Dog&Harp
Telephone
Telephone 2
Door Creak
Door Slam
Scratch
Wind Chime
Helicopter
Car Engine
Car Stopping
Car Passing
Car Crash
Siren
Train
Jet Plane
Starship
Burst Noise
Applause
Laughing
Screaming
Punch
Heartbeat
Foot Step
Gunshot
Machine Gun
Laser Gun
Explosion
OTHERS : DRUMKIT
Standard Set
Room Set
Power Set
Electronic Set
Analog Set
Jazz Set
Brush Set
Orchestra Set
SFX Set

Drum Sound Mapping List

	Standard Set	Room Set	Power Set	Electronic Set
C#				
D				
D#	High Q	High Q	High Q	High Q
E	Slap	Slap	Slap	Slap
F	Scratch Push	Scratch Push	Scratch Push	Scratch Push
F#	Scratch Pull	Scratch Pull	Scratch Pull	Scratch Pull
G	Sticks	Sticks	Sticks	Sticks
G#	Square Click	Square Click	Square Click	Square Click
A	Metronome Click	Metronome Click	Metronome Click	Metronome Click
A#	Metronome Bell	Metronome Bell	Metronome Bell	Metronome Bell
B	Acoustic Bass Drum	Acoustic Bass Drum	Acoustic Bass Drum	Acoustic Bass Drum
C2	C	Bass Drum 1	Power Kick Drum	Electric Bass Drum
	C#	Side Stick	Side Stick	Side Stick
	D	Acoustic Snare	Acoustic Snare	Power Snare Drum
	D#	Hand Clap	Hand Clap	Hand Clap
	E	Electric Snare	Electric Snare	Electric Snare 2
	F	Low Floor Tom	Room Low Tom 2	Power Low Tom 2
	F#	Closed Hi-hat	Closed Hi-hat	Closed Hi-hat
	G	High Floor Tom	Room Low Tom 1	Power Low Tom 1
	G#	Pedal Hi-hat	Pedal Hi-hat	Pedal Hi-hat
	A	Low Tom	Room Mid Tom 2	Power Mid Tom 2
	A#	Open Hi-hat	Open Hi-hat	Open Hi-hat
	B	Low-Mid Tom	Room Mid Tom 1	Power Mid Tom 1
C3	C	High-Mid Tom	Room Hi Tom 2	Power Hi Tom 2
	C#	Crash Cymbal 1	Crash Cymbal 1	Crash Cymbal 1
	D	Hi Tom	Room Hi Tom 1	Power Hi Tom 1
	D#	Ride Cymbal 1	Ride Cymbal 1	Ride Cymbal 1
	E	Chinese Cymbal	Chinese Cymbal	Chinese Cymbal
	F	Ride Bell	Ride Bell	Ride Bell
	F#	Tambourine	Tambourine	Tambourine
	G	Splash Cymbal	Splash Cymbal	Splash Cymbal
	G#	Cowbell	Cowbell	Cowbell
	A	Crash Cymbal 2	Crash Cymbal 2	Crash Cymbal 2
	A#	Vibra-slap	Vibra-slap	Vibra-slap
	B	Ride Cymbal 2	Ride Cymbal 2	Ride Cymbal 2
C4	C	High Bongo	High Bongo	High Bongo
	C#	Low Bongo	Low Bongo	Low Bongo
	D	Mute Hi Conga	Mute Hi Conga	Mute Hi Conga
	D#	Open Hi Conga	Open Hi Conga	Analog Mid Conga
	E	Low Conga	Low Conga	Analog Low Conga
	F	High Timbale	High Timbale	High Timbale
	F#	Low Timbale	Low Timbale	Low Timbale
	G	High Agogo	High Agogo	High Agogo
	G#	Low Agogo	Low Agogo	Low Agogo
	A	Cabasa	Cabasa	Cabasa
	A#	Maracas	Maracas	Maracas
	B	Short Whistle	Short Whistle	Short Whistle
C5	C	Long Whistle	Long Whistle	Long Whistle
	C#	Short Guiro	Short Guiro	Short Guiro
	D	Long Guiro	Long Guiro	Long Guiro
	D#	Claves	Claves	Claves
	E	Hi Wood Block	Hi Wood Block	Hi Wood Block
	F	Low Wood Block	Low Wood Block	Low Wood Block
	F#	Mute Cuica	Mute Cuica	Mute Cuica
	G	Open Cuica	Open Cuica	Open Cuica
	G#	Mute Triangle	Mute Triangle	Mute Triangle
	A	Open Triangle	Open Triangle	Open Triangle
	A#	Shaker	Shaker	Shaker
	B	Jingle Bell	Jingle Bell	Jingle Bell
C6	C	Bell Tree	Bell Tree	Bell Tree
	C#	Castanets	Castanets	Castanets
	D	Mute Surdo	Mute Surdo	Mute Surdo
	D#	Open Surdo	Open Surdo	Open Surdo
	E			

	Analog Set	Jazz Set	Brush Set	Orchestra Set	SFX Set
C#					
D					
D#	High Q	High Q	High Q	Closed Hi-hat 2	
E	Slap	Slap	Slap	Pedal Hi-hat	
F	Scratch Push	Scratch Push	Scratch Push	Open Hi-hat 2	
F#	Scratch Pull	Scratch Pull	Scratch Pull	Ride Cymbal 1	
G	Sticks	Sticks	Sticks	Sticks	
G#	Square Click	Square Click	Square Click	Square Click	
A	Metronome Click	Metronome Click	Metronome Click	Metronome Click	
A#	Metronome Bell	Metronome Bell	Metronome Bell	Metronome Bell	
B	Acoustic Bass Drum	Jazz Kick 2	Jazz Kick 2	Concert BD 2	
C2					
C	Analog Bass Drum	Jazz Kick 1	Jazz Kick 1	Concert BD 1	
C#	Analog Rim Shot	Side Stick	Side Stick	Side Stick	
D	Analog Snare 1	Acoustic Snare	Brush Tap	Concert SD	
D#	Hand Clap	Hand Clap	Brush Slap	Castanets	High Q
E	Electric Snare	Electric Snare	Brush Swirl	Concert SD	Slap
F	Analog Low Tom 2	Low Floor Tom	Low Floor Tom	Timpani F	Scratch Push
F#	Analog CHH 1	Closed Hi-hat	Closed Hi-hat	Timpani F#	Scratch Pull
G	Analog Low Tom 1	High Floor Tom	High Floor Tom	Timpani G	Sticks
G#	Analog CHH 2	Pedal Hi-hat	Pedal Hi-hat	Timpani G#	Square Click
A	Analog Mid Tom 2	Low Tom	Low Tom	Timpani A	Metronome Click
A#	Analog OHH	Open Hi-hat	Open Hi-hat	Timpani A#	Metronome Bell
B	Analog Mid Tom 1	Low-Mid Tom	Low-Mid Tom	Timpani B	Guitar Fret Noise
C3					
C	Analog Hi Tom 2	High-Mid Tom	High-Mid Tom	Timpani c	Guitar Cutting Noise Up
C#	Analog Cymbal	Crash Cymbal 1	Crash Cymbal 1	Timpani c#	Guitar Cutting Noise Down
D	Analog Hi Tom 1	Hi Tom	Hi Tom	Timpani d	String Slap of Double Bass
D#	Ride Cymbal 1	Ride Cymbal 1	Ride Cymbal 1	Timpani d#	Fl. Key Click
E	Chinese Cymbal	Chinese Cymbal	Chinese Cymbal	Timpani e	Laughing
F	Ride Bell	Ride Bell	Ride Bell	Timpani f	Scream
F#	Tambourine	Tambourine	Tambourine	Tambourine	Punch
G	Splash Cymbal	Splash Cymbal	Splash Cymbal	Splash Cymbal	Heart Beat
G#	Analog Cowbell	Cowbell	Cowbell	Cowbell	Footsteps 1
A	Crash Cymbal 2	Crash Cymbal 2	Crash Cymbal 2	Concert Cymbal 2	Footsteps 2
A#	Vibra-slap	Vibra-slap	Vibra-slap	Vibra-slap	Applause
B	Ride Cymbal 2	Ride Cymbal 2	Ride Cymbal 2	Concert Cymbal 1	Door Creaking
C4					
C	High Bongo	High Bongo	High Bongo	High Bongo	Door
C#	Low Bongo	Low Bongo	Low Bongo	Low Bongo	Scratch
D	Analog Hi Conga	Mute Hi Conga	Mute Hi Conga	Mute Hi Conga	Wind Chimes
D#	Analog Mid Conga	Open Hi Conga	Open Hi Conga	Open Hi Conga	Car-Engine
E	Analog Low Conga	Low Conga	Low Conga	Low Conga	Car-Stop
F	High Timbale	High Timbale	High Timbale	High Timbale	Car-Pass
F#	Low Timbale	Low Timbale	Low Timbale	Low Timbale	Car-Crash
G	High Agogo	High Agogo	High Agogo	High Agogo	Siren
G#	Low Agogo	Low Agogo	Low Agogo	Low Agogo	Train
A	Cabasa	Cabasa	Cabasa	Cabasa	Jetplane
A#	Analog Maracas	Maracas	Maracas	Maracas	Helicopter
B	Short Whistle	Short Whistle	Short Whistle	Short Whistle	Startship
C5					
C	Long Whistle	Long Whistle	Long Whistle	Long Whistle	Gun Shot
C#	Short Guiro	Short Guiro	Short Guiro	Short Guiro	Machine Gun
D	Long Guiro	Long Guiro	Long Guiro	Long Guiro	Lasergun
D#	Analog Claves	Claves	Claves	Claves	Explosion
E	Hi Wood Block	Hi Wood Block	Hi Wood Block	Hi Wood Block	Dog
F	Low Wood Block	Low Wood Block	Low Wood Block	Low Wood Block	Horse-Gallop
F#	Mute Cuica	Mute Cuica	Mute Cuica	Mute Cuica	Birds
G	Open Cuica	Open Cuica	Open Cuica	Open Cuica	Rain
G#	Mute Triangle	Mute Triangle	Mute Triangle	Mute Triangle	Thunder
A	Open Triangle	Open Triangle	Open Triangle	Open Triangle	Wind
A#	Shaker	Shaker	Shaker	Shaker	Seashore
B	Jingle Bell	Jingle Bell	Jingle Bell	Jingle Bell	Stream
C6					
C	Bell Tree	Bell Tree	Bell Tree	Bell Tree	Bubble
C#	Castanets	Castanets	Castanets	Castanets	
D	Mute Surdo	Mute Surdo	Mute Surdo	Mute Surdo	
D#	Open Surdo	Open Surdo	Open Surdo	Open Surdo	
E				Applause	

Drum Rhythm List

No.	Rhythm Name
1	8 Beat 1
2	8 Beat 2
3	8 Beat 3
4	16 Beat 1
5	16 Beat 2
6	16 Beat 3
7	16 Beat 4
8	16 Beat 5
9	16 Beat 6
10	Rock Beat 1
11	Rock Beat 2
12	Rock Beat 3
13	Hard Rock
14	Heavy Beat
15	Surf Rock
16	2nd Line
17	50 Ways
18	Ballad 1
19	Ballad 2
20	Ballad 3
21	Ballad 4
22	Ballad 5
23	Light Ride 1
24	Light Ride 2
25	Smooth Beat
26	Rim Beat
27	Slow Jam
28	Pop 1
29	Pop 2
30	Electro Pop 1
31	Electro Pop 2
32	Ride Beat 1
33	Ride Beat 2
34	Ride Beat 3
35	Ride Beat 4
36	Slip Beat
37	Jazz Rock
38	Funky Beat 1
39	Funky Beat 2
40	Funky Beat 3
41	Funk 1
42	Funk 2
43	Funk 3
44	Funk Shuffle 1
45	Funk Shuffle 2
46	Buzz Beat
47	Disco 1
48	Disco 2
49	Hip Hop 1
50	Hip Hop 2

No.	Rhythm Name
51	Hip Hop 3
52	Hip Hop 4
53	Techno 1
54	Techno 2
55	Techno 3
56	Heavy Techno
57	8 Shuffle 1
58	8 Shuffle 2
59	8 Shuffle 3
60	Boogie
61	16 Shuffle 1
62	16 Shuffle 2
63	16 Shuffle 3
64	T Shuffle
65	Triplet 1
66	Triplet 2
67	Triplet 3
68	Triplet 4
69	Triplet Ballad 1
70	Triplet Ballad 2
71	Triplet Ballad 3
72	Motown 1
73	Motown 2
74	Ride Swing
75	H.H. Swing
76	Jazz Waltz 1
77	Jazz Waltz 2
78	5/4 Swing
79	Fast 4 Beat
80	H.H. Bossa Nova
81	Ride Bossa Nova
82	Beguine
83	Mambo
84	Cha Cha
85	Samba
86	Light Samba
87	Surdo Samba
88	Latin Groove
89	Afro Cuban
90	Songo
91	Bembe
92	Merenge
93	Reggae
94	Tango
95	Habanera
96	Waltz
97	Ragtime
98	Country & Western
99	March
100	6/8 March

Specifications

Kawai CN39 Digital Piano	
Keyboard	88 weighted keys with Ivory Touch key surfaces Responsive Hammer III (RHIII) action with Let-Off, Triple Sensor, and Counterweights
Sound Source	Progressive Harmonic Imaging™ (PHI), 88-key piano sampling
Internal Sounds	355 voices PIANO1 x 7, PIANO2 x 7, E.PIANO x 7, ORGAN x 8, HARPSI & MALLETS x 6, STRINGS & CHOIR x 8, BASS x 4, OTHERS x 308 (including 9 drum sets)
Polyphony	max. 256 notes
Keyboard Modes	Dual Mode, Split Mode, Four Hands Mode (Volume/Balance adjustable)
Reverb	Type: Room, Lounge, Small Hall, Concert Hall, Live Hall, Cathedral
	Parameters: Reverb Depth, Reverb Time
Effects	Type: Mono Delay, Ping Delay, Triple Delay, Chorus, Classic Chorus, Ensemble, Tremolo, Classic Tremolo, Vibrato Tremolo, Tremolo+Amp, Auto Pan, Classic Auto Pan, Auto Pan+Amp, Phaser+Auto Pan, Phaser, Classic Phaser, Phaser+Amp, Phaser+Chorus, Rotary (1~6)
	Parameters: Dry/Wet, Time, Speed, Mono/Stereo, Accel./Rotary Speed – Parameters dependent on effect.
Virtual Technician	Touch Curve: Light 1/2/3/4, Normal, Heavy 1/2/3/4, Off (Constant), User Touch Curve
	Voicing: Normal, Mellow 1, Mellow 2, Dynamic, Bright 1, Bright 2, User Voicing
	Resonance, Noise & Effects: Damper Resonance, Damper Noise, String Resonance, Undamped String Resonance, Cabinet Resonance, Key-off Effect, Fall-back Noise, Topboard Simulation, Decay Time
	Temperament & Tuning: Equal, Pure Major, Pure Minor, Pythagorean, Meantone, Werckmeister, Kirnberger, User Temperament, Temperament Key, Stretch Tuning, User Tuning
Others: Hammer Delay, Minimum Touch, User Key Volume, Half-Pedal Adjust, Soft Pedal Depth	
Internal Recorder	10 song, 2 track recorder – approximately 90,000 note memory capacity
USB Functions	Playback: MP3, WAV, SMF (16 track)
	Record: MP3, WAV, SMF (16 track)
	Others: Load Song, Load Registration All, Load Registration Single, Load Startup Setting, Save Internal Song, Save SMF Song, Save Registration All, Save Registration Single, Save Startup Setting, Rename File, Delete File, Format USB, Convert Song to Audio, Overdub Audio, Edit MIDI File
Metronome	Beat: 1/4, 2/4, 3/4, 4/4, 5/4, 3/8, 6/8, 7/8, 9/8, 12/8 + 100 drum rhythms
	Tempo: 10~400 bpm (20~800 bpm for eighth note rhythms)
Music Menu	Demo Songs: 32 songs
	Piano Music: 29 or 42 songs ¹
	Lesson Function: Songs from Alfred, Burgmüller, Czerny, Beyer, and Bach lesson books ² . Finger Exercises
	Concert Magic: 176 songs (88 x 2 banks)
Registrations	16 memories (8 x 2)
Other Settings & Functions	Key Transpose, Song Transpose, Tone Control (incl. User EQ), Speaker Volume, Tuning, Damper Hold, Split, Four Hands, Startup Setting, Factory Reset, Auto Display Off, Auto Power Off, SHS Mode, Phones Type, Phones Volume, Lower Octave Shift, Lower Pedal On/Off, Split Balance, Layer Octave Shift, Layer Dynamics, Dual Balance, MIDI Channel, Send PGM#, Local Control, Transmit PGM#, Multi-timbral Mode, Channel Mute, Bluetooth Audio, Bluetooth Audio Volume, Bluetooth MIDI, Audio Recorder Gain
Display	128 x 64 pixel OLED
Pedals	Sustain (with half-pedal support), Soft, Sostenuto. Grand Feel Pedal System
Bluetooth*	Bluetooth (Ver. 4.1; GATT compatible) Bluetooth Low Energy MIDI Specification compliant, Bluetooth Audio
Connectors	LINE IN (1/4" L/MONO, R), LINE OUT (1/4" L/MONO, R), Headphones x 2 (1/4", 1/8") MIDI (IN/OUT), USB to Host, USB to Device
Speaker System	Speakers: 13 cm x 2 (woofer) (8 x 12 cm) x 2 (top speaker)
	Output Power: 20 W x 2
Power Consumption	20 W (PS-154 AC adaptor)
Dimensions (Not including music rack)	1445 (W) x 435 (D) x 880 (H) mm 57" (W) x 17 1/2" (D) x 33 3/4" (H)
Weight	54 Kg / 119 lbs.

¹ Depending on market location. ² Lesson books sold separately.

Specifications are subject to change without notice.

* Availability of Bluetooth function dependent on market location.

KAWAI

THE FUTURE OF THE PIANO

