



**F-6 Fazer  
Fog Machine  
User Manual  
- English  
- 中文**



© 2023 Antari Lighting and Effects Ltd.

1. Introduction .....	1
2. Safety Information.....	1
3. Package Contents & Inspection.....	2
4. Machine Details.....	3
5. Technical Label Information.....	3
6. Fog Fluid.....	3
7. Setting and Manual Operation.....	4
8. Control Settings .....	4
9. Machine Status Description.....	5
10. DMX Connection .....	6
11. RDM Function.....	6
12. ES-W-DMX (Optional) .....	7
13. WTR-110 Wireless Remote (Optional) .....	8
14. Service and Maintenance.....	9
15. Technical Specifications .....	9
16. Warranty Disclaimer.....	9
17. Machine Dimension.....	10
1. 前言 .....	11
2. 安全注意事項 .....	11
3. 包裝內容與檢查 .....	12
4. 機器訊息 .....	13
5. 技術標籤資訊 .....	13
6. 煙霧水 .....	13
7. 設定與手動操作說明 .....	14
8. 控制設定 .....	14
9. 機器狀態 .....	15
10. DMX 說明 .....	16
11. RDM 說明 .....	17
12. ES-W-DMX 無線 DMX 說明(選配).....	17
13. WTR-110 無線控制器(選配).....	18
14. 維護和保養 .....	19
15. 技術規格 .....	20
16. 機器尺寸圖 .....	20
17. 保固聲明 .....	20
Appendix I – Grounding Instruction.....	21





## User Manual

### 1. Introduction

Please read all the user manual before operating the machine, and place the manual where the user can refer to it at all time. The manual includes how to install and operate the machine under safe condition and explain all the labels printed on the machine. If you encounter any problem, contact your local Antari dealer for assistant immediately.

### 2. Safety Information

 <b>DANGER</b>	If the danger is not avoided, it will cause death or serious injury
 <b>WARNING</b>	If the warning is not heeded, it can cause death or serious injury.
 <b>CAUTION</b>	If the precaution is not taken, it may cause minor or moderate injury.



#### **DANGER**

- Must connect the machine to the correct rated voltage or it might lead to an electrical shock or a burn and may cause serious consequences.
- Must connect the machine to a protected circuit and ensure it is properly grounded to avoid the risk of electrocution. For grounding instruction, please refer to Appendix I on page 21.
- Do not operate the machine with a bundled power cord, it could lead to a fire hazard.
- When operating the machine, do not point at people, animals, or fire.



#### **WARNING**

- Please operate the machine on a flat, level hard and well ventilated surface area, reserve at least 50cm space around the machine and make sure there is no flammable gas or material nearby.
- Do not disassemble, repair or modify the machine, it may cause damages, malfunction, risk of electrical shock or result in fire.
- The machine can only be operated by adults or professionals, is not intended for use by person with reduced physical sensory, mental capabilities, or lack of experience and knowledge including children.
- Do not leave the machine running unattended, make sure all powers are off when leaving.
- Children should be supervised to ensure that they do not play with the machine.
- Do not use the machine upside down or tilt it, it might cause damages or malfunction.
- Please store the fluid inside in a well ventilated area without direct sunlight and keep out of reach of children. In case of eye contact or accidentally swallow the fluid, please seek medical attention immediately.



#### **CAUTION**

- Keep the machine dry at all time. The machine is not waterproof, do not expose the machine to water, rain, or moisture environment.
- Please make sure the power outlet is not damaged or loose before plug in the power cord.
- If the power cord is damaged, it must be replaced by Antari or its local dealers, otherwise the warranty will be void.
- Before operating the machine, please make sure the fluid is filled in the fluid tank to avoid the pump in idling

state which could lead to overheat or malfunction.

- Before transporting the machine, please make sure the fluid is drained and tank is empty. (Recommend using original package)
- The machine is for indoor use only.
- Do not operate the machine in any area with unstable voltage.
- If you experience strange sound or malfunction, turn off the power and unplug the power cord immediately and contact your local Antari dealer for assistant.
- Do not contact any moving part.
- Only use accessories recommended or sold by Antari.
- Please make sure the power is off when not using the machine and unplug the power cord if not intend to use for a long period of time.
- To disconnect, turn all controls to the off position, then remove plug from outlet.
- Do not unplug by pulling on cord. To unplug, grasp the plug, not the cord.
- Unplug from outlet before servicing or cleaning.
- Do not operate the machine with a damaged cord or plug, or after the machine malfunctions or is dropped or damaged in any manner. Return machine to the nearest authorized service facility for examination, repair, or electrical or mechanical adjustment.
- To ensure the lifespan of the machine, please only use the fluid manufactured by Antari, do not use other fluid or additive, otherwise it may clog the heater and cause malfunction.

Before operating the machine, please read all warning labels on the machine, description as below;

**CAUTION!**

NEVER ADD FLAMMABLE SUBSTANCES.

**WARNING!**

DISCONNECT POWER BEFORE CHANGING FUSE.

USE ONLY WITH ADULT SUPERVISION.

DO NOT OPERATE WITHOUT LIQUID.

FOR INDOOR USE ONLY. KEEP DRY.

NO USER SERVICEABLE PARTS INSIDE.

### 3. Package Contents & Inspection

Immediately upon receiving the machine, carefully unpack the carton, check the content to ensure it is the correct model and all parts are included. If any part appears to be damaged or missing during transportation, please contact your local dealer and return in original package for inspection.

#### 3.1 Package Contents

- 1 x F-6 Fazer Fog Machine
- 1 x Neutrik powerCON Power Cable
- 1 x User Manual or Scan QR Code on the Machine

#### 3.2 Optional Accessories

Item Code	Description
ES-W-DMX	W-DMX Receiver
WTR-110	Wireless Remote (W-2 Transmitter/Receiver)

## 4. Machine Details

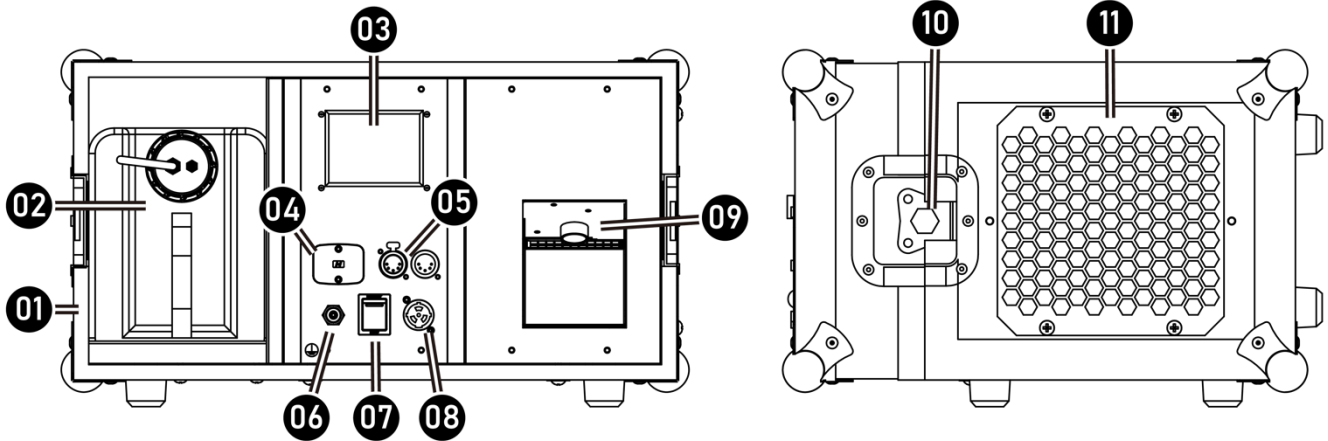

01. Flight Case	07. Two in One Power & Breaker Switch
02. 5 Liter Fluid Tank	08. Neutrik powerCON Chassis Connector
03. TFT-LCD Touch Screen Display	09. Fog Nozzle
04. Expansion Socket	10. Flight Case Lock
05. XLR 5-Pin Connector (DMX)	11. Cooling Net
06. Fluid Tube Connector	

## 5. Technical Label Information

Please read the technical label information on the back of the machine before operating it.

1. Model Name	5. Breaker/Fuse
2. Input Voltage	6. QR CODE for User Manual
3. Frequency	7. Serial No.
4. Rated Power	

## 6. Fog Fluid

	<b>CAUTION</b>	Always turn off the power before filling the fluid tank. Do not add flammable liquid to the fluid tank. If fluid gets inside the machine, please contact your local Antari dealer for assistant.
--	----------------	--

- Only the fog fluid manufactured by Antari can be used, do not mix or dilute the fog fluid. Due to improper storage or using other fluid might clog the heater and cause malfunction.
- The machine is tested and calibrated with the specific fog fluid to get the best performance.
- Please empty the fluid in the tank before switching to another fluid to avoid mixing.
- Only the essence manufactured by Antari can be used, and add according to the ratio recommended by Antari (Recommended ratio is 1:1000), if using other essence or different ratio might clog the heater and cause malfunction.
- The warranty on your fog machine will be void if you use fog fluid not manufacture by Antari.

## 7. Setting and Manual Operation

	<b>WARNING</b>	Machine falling off might cause serious injury, please make sure it is secure and firm on the overhead.
---	----------------	---

- Step 1.** Place the machine on a flat, level hard and well ventilated surface area and reserve at least 50cm open space around the machine, and make sure there is no flammable gas or material nearby;
- Step 2.** Fill the fluid tank with Antari approved fog liquid, and make sure the tube is not twisted;
- Step 3.** Connect the machine to the power outlet. Please read the technical label on the back of the machine and make sure the power outlet is the correspond to the rated voltage for the machine;
- Step 4.** Turn on the machine, heating process takes approximately 1 minutes. Once the machine has reached operating temperature “100%” (Top Left Hand Corner), the machine is ready for operation;
- Step 5.** To activate fogging in manual mode, please press “Manual” and adjust output and fan speed according to your need then press start and press again to stop fogging;
- Step 6.** Or to activate fogging in Timer mode, please press “Timer” and adjust “Interval”; “Duration”; “Output” and “Fan Speed” according to your need, then press start and press again to stop fogging;
- Step 7.** Press “DMX” and adjust according to your need;
- Step 8.** Press “MENU” and adjust according to your need;
- Step 9.** To turn off the machine, please make sure the machine is not operating then turn of the power. If you will not use the machine a long period of time, please remove the power cord.

## 8. Control Settings

F-6 Fazer Fog Machine can be operated in the following modes. The machine can only accept 1 type of signal at a time. When using different control modes at the same time, the machine will work according to built-in control priority:

- Manual
- Timer
- DMX512
- W-DMX
- Wireless

### 8.1 Control Panel Description

F-6 Fazer Fog Machine can be operated with the onboard TFT-LCD Touch Screen.

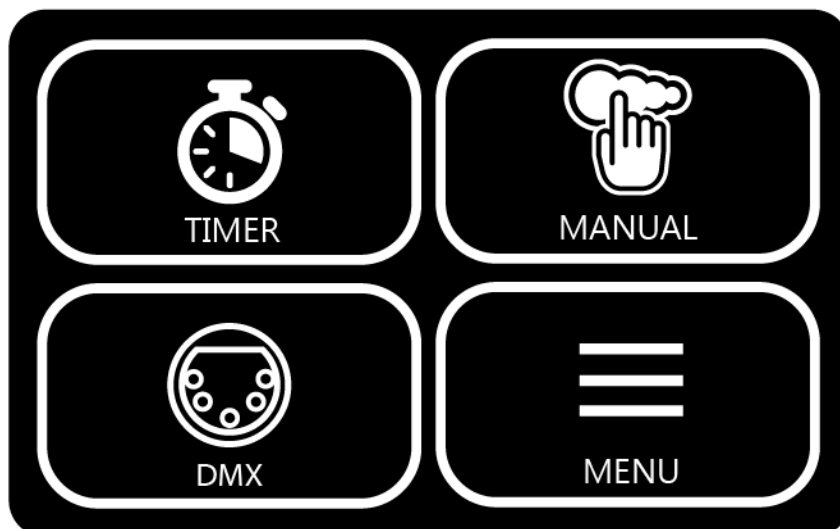

Icon	Operating Method	Action
	Press	Confirmed Selection
	Press	Adjust Values
	Press	Back to Last Page
	Press	Active
	Press	De-Active
	Press	Enter Configuration
 (Green Background Color)	N/A	Selected Mode in Action

## 8.2 Control Menu

Main Menu	Item	Description	
Timer	Interval	1 – 999 sec	
	Duration	1 – 999 sec	
	Output Level	1 – 100%	
	Fan Level	20 – 100%	
Manual	Output Level	1 – 100%	
	Fan Level	20 – 100%	
W-DMX	Address	001-512	
	Channel Mode	3 Modes	
	W-DMX Power	On/Off	
	W-DMX Reset	Unpair	
Menu	Information	Software Version	
	Setting	LCD BackLight	High/Mid/Low/AutoOff
		Run Last	On/Off
		Language	English/中文/日本語
		WRC Pairing	Pair/Unpair
Self Clean Mode	Count 180 sec		

## 9. Machine Status Description

### 9.1 Machine Status with TFT-LCD Touch Screen Display

Screen	Description
AC Frequency	Input Frequency
Antari F-6 Ready To Fog	Machine is ready to Operate (Top Left Corner show 100% On The Screen) W-DMX Status  WDMX (Top Right Hand Corner On the Display, please see 12.3 for more details) Wireless Signal
Manual Output 100%	Fog Output level at Manual Mode
Interval 1 - 999 sec Duration 1 - 999 sec	Running at Timer mode, Interval time Running at Timer mode, Duration time
DMX-512 Add: XXX	Current DMX 512 channel
Self-Cleaning Mode	Count Down 180 sec and Machine in Sleep Mode
Warming Up 10 %	Heating up 0-100% (Upper Left Corner)
Heater Overheat!	Heater is Overheat
Heater Fault	Heater Malfunction
Thermal Line Off	Thermal Line Break Off
Line Reverse	Thermal Line Reverse Connection
Voltage Error	Incorrect Voltage

\*\*If LCD control panel display “Warning”, please stop operating and turn off the machine immediately. Please contact your local Antari dealer for assistance.

## 10. DMX Connection

### 10.1 DMX Connector Pin Assignment

The machine provides a XLR 5-Pin connector for DMX connection. The diagram below indicates pin assignment information;

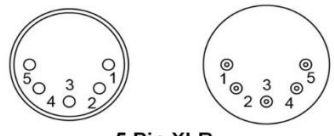
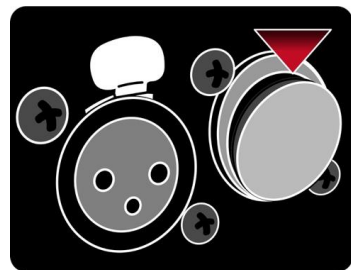
 <p>5 Pin XLR</p> <table border="1" style="margin-left: auto; margin-right: auto; border-collapse: collapse;"> <thead> <tr> <th style="width: 15%;">Pin</th> <th style="width: 85%;">Function</th> </tr> </thead> <tbody> <tr> <td style="text-align: center;">1</td> <td>Ground</td> </tr> <tr> <td style="text-align: center;">2</td> <td>Data-</td> </tr> <tr> <td style="text-align: center;">3</td> <td>Data+</td> </tr> <tr> <td style="text-align: center;">4</td> <td>N/A</td> </tr> <tr> <td style="text-align: center;">5</td> <td>N/A</td> </tr> </tbody> </table>	Pin	Function	1	Ground	2	Data-	3	Data+	4	N/A	5	N/A	<p>** There is a protection cap on DMX IN, please remove it with your finger before operation.</p> 
Pin	Function												
1	Ground												
2	Data-												
3	Data+												
4	N/A												
5	N/A												

### 10.2 DMX Channel Function

This machine provides 2 channel DMX and 3 modes to choose, please see chart below.

Channel Mode		DMX Value Range	Function
Channel 1	Fog Output Level	0 – 5	Off
		6 – 255	1 – 100%
Channel 2	Fan Speed	0-50	20%
		51-255	21-100%
Channel Mode		Function	
Mode 1	Channel 1	Ch1 and Ch2 Sync Output	
Mode 2	Channel 1	Ch1 and Fan Speed at 100%	
Mode 3	Channel 2	Ch1 Fog Output and Ch2 Fan Speed	

## 11. RDM Function

The F-6 Fazer Fog Machine is RDM enabled, allowing control system to configure, monitor and manage. See below table for supported RDM parameters.

GET Allowed	SET Allowed	Category	RDM Parameter ID's(Slot 21-22)	Value	Required
		NetworkManagement 網路管理	DISC_UNIQUE_BRANCH	0x0001	O
				0x0002	O
				0x0003	O
O		RDM Information RDM 資訊	QUEUED_MESSAGE	0x0020	
O			STATUS_MESSAGES	0x0030	
O			SUPPORTED_PARAMETERS	0x0050	O
O			PAPAMETER_DESCRIPTION	0x0051	O
O		Product Information 產品資訊	DEVICE_INFO	0x0060	O
O			PRODUCT_DETAIL_ID_LIST	0x0070	
O			DEVICE_MODE_DESCRIPTION	0x0080	
O			MANUFACTURER_LABEL	0x0081	
O	O		DEVICE_LABEL	0x0082	
O			SOFTWARE_VERSION_LABEL	0x00C0	O



GET Allowed	SET Allowed	Category	RDM Parameter ID's(Slot 21-22)	Value	Required
○	○	DMX512 Setup DMX512 設定	DMX_PERSONALITY	0x00E0	
○			DMX_PERSONALITY_DESCRIPTION	0x00E1	
○	○		DMX_START_ADDRESS	0x00F0	○
○			SLOT_INFO	(0x0120)	
○			SLOT_DESCRIPTION	(0x0121)	
○			DEFAULT_SLOT_VALUE	(0x0122)	
○		Sensors 感應器	SENSOR_DEFINITION	0x020	
○	○		SENSOR_VALUE	0x0201	
○		Control 控制	DEVICE_HOURS	0x0400	
○	○		IDENTIFY_DEVICE	0x1000	○
○	○		POWER_STATE	0x1010	

## 12. ES-W-DMX (Optional)

ES-W-DMX is an optional accessory for F-6 Fazer Fog Machines. If you already purchased the W-DMX model, it's ready to use. If you purchase it afterwards, please follow the instruction below. If you encounter any problem, please contact your local Antari dealer for assistant. The W-DMX Control supports both CRMX and W-DMX protocols

### 12.1 ES-W-DMX Receiver

It includes a Wireless DMX Receiver.

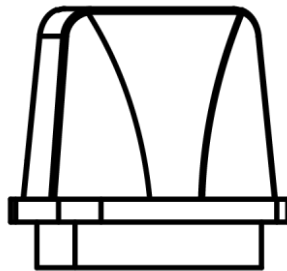

### 12.2 ES-W-DMX Receiver Installation Steps

If you purchased the W-DMX Receiver afterward, please follow the instruction below to install the receiver. If you encounter any problem, please contact your local Antari dealer for assistant.

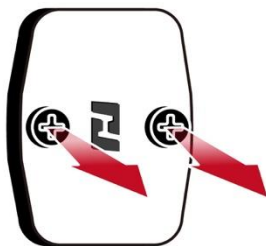

Graph 1

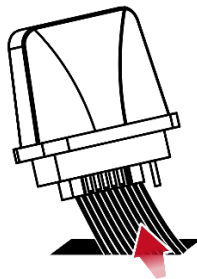

Graph 2



Graph 3

1. Please see graph 1, remove the cover from the pointed place;
2. You will see a white cable like graph 2, pull it out and connect to receiver;
3. Screw it back to the machine like graph 3, then it's ready to use.

### 12.3 Status of W-DMX Signal

To Activate the function, please follow the instruction below,

1. Enter DMX Setting Menu
2. Find [W-DMX Power] and activate it, then you will see on the screen.

Signal on LCD display	W-DMX Status
○ (Green Light)	W-DMX present
◎	No DMX present
◐	Link to TX lost
● (Red Light)	Not assigned

### 13. WTR-110 Wireless Remote (Optional)

WTR-110 Wireless Remote is an optional accessory for F-6 Fazer Fog Machines, it included a W-2 wireless transmitter and a wireless receiver. If you already purchased the wireless model, it's ready to use. If you purchase the module afterward, please follow the instruction below. If you encounter any problem, please contact your local Antari dealer for assistant.

#### 13.1 Wireless Transmitter & Receiver

- Battery : 27A 12V
- Effective Range : The effective range is approximately 50 meter, depends on actual condition, it may vary.
- W-2 wireless transmitter has 4 buttons, each function as follow:



W-2 Wireless Transmitter

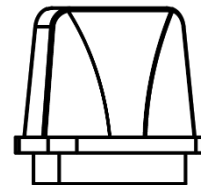

Wireless Receiver

Button	Function
[A]	Start Fogging
[B]	Stop Fogging
[C]	Increase fog output
[D]	Decrease fog output

#### 13.2 Wireless Receiver Installation

If you purchased the WTR-110 Wireless Remote afterward, please follow the instructions below to install the receiver. If you encounter any problem, please contact your local Antari dealer for assistant.

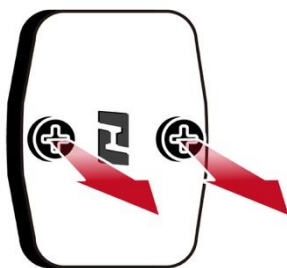

Graph 1

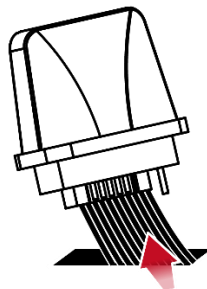

Graph 2



Graph 3

1. Please see graph 1, remove the cover from the pointed place;
2. You will see a white cable like graph 2, pull it out and connect to the W-2 receiver;
3. Screw it back to the machine like graph 3 and follow the instruction on 13.3 for pairing.

#### 13.3 Pair & Unpair

Each wireless receiver can pair up to 5 transmitters, please follow the steps below to pair or unpair the module;

- Step 1.** Machine need to be in READY status in order to pair with transmitter;
- Step 2.** Press [MENU] to enter options;
- Step 3.** Press arrow and find [WRC Pairing];
- Step 4.** Press [Pair] then press [A] button on the transmitter to pair;
- Step 5.** Press [Unpair] to unpair and the machine will restart when it's successful.

## 14. Service and Maintenance

	<b>DANGER</b>	Disconnect the power cord before starting maintenance operation!
---	---------------	--

- Always keep the machine clean.
- Can use air compressor, vacuum or a soft brush to remove the dust on the machine.
- Can use a slightly damp cloth to clean the casing.
- Before store the machine, please make sure the machine is completely cool down to avoid moisture inside causing malfunction.
- It is recommended to run the machine at least once a month in order to maintain the machine's best performance and output condition.
- Excessive dust and build up liquid residue will reduce the performance and cause overheat.

### 14.1 Breaker Reset (2 in 1 Power Switch)

The 2 in 1 power switch combines power and breaker function.

Please follow below steps to reset the breaker;

Step 1: Please switch to the OFF position;

Step 2: Wait 60 seconds;

Step 3: Flip switch to ON position.

\*\*If the breaker (switch) still jumps off after reset, please contact your local Antari dealer for assistance.

**Breaker Specification**    100-120V = 15A 250V  
    220-240V = 9A 250V

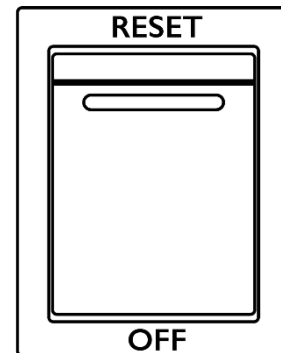

## 15. Technical Specifications

F-6 Fazer	
<b>Rated Voltage</b>	US Model : AC 100-120V, 50/60Hz 12.5A EU Model : AC 220-240V, 50/60Hz 6.5A
<b>Rated Power</b>	1450W
<b>Warming-up Time</b>	1 minutes (Approx.)
<b>Fluid Consumption</b>	12 ml/min (100% Output)
<b>Operating Time</b>	7 hrs at Max. Output
<b>Fluid Tank Capacity</b>	5 Liters (1.32 gallon)
<b>Compatible Fluid</b>	Antari FLG-5E Heavy Fog Fluid
<b>Ambient Temp. Range</b>	0°C – 40°C (32°F – 104°F)
<b>Control Methods</b>	Manual · Timer · DMX 512 · WDMX (Optional) · Wireless (Optional)
<b>Interface</b>	XLR 5-Pin (DMX) · Neutrik powerCON (Power)
<b>DMX Channels</b>	2 Channels
<b>Included Accessories</b>	N/A
<b>Optional Accessories</b>	WTR-110 Wireless Remote · ES-W-DMX
<b>Dimension</b>	L 493 W 424 H 280 mm (L 19.4 W 16.69 H 10.59 inch)
<b>Weight</b>	17.2 kg (37.80 lbs.)

## 16. Warranty Disclaimer

We guarantee the merchandise manufactured by us to be free from defect in material and workmanship for a period of one year. Our obligation and liability under this warranty shall be restricted to repair or replacement at our factory or local authorized dealer. We assume no liability of the products that are improperly used or used for any

purpose other than that for which they are specially designed. This warranty shall not apply to any merchandise which has been repaired, altered or assembled outside our factory in any way so as in our judgment to affect its performance, nor which has been subjected to misuse, negligence, or accident nor to any merchandise operated contrary to our printed instructions. We will not allow or be liable of any loss or any damages of any kind in connection with the use, sale, or repair of any merchandise purchased from us.

### 17. Machine Dimension

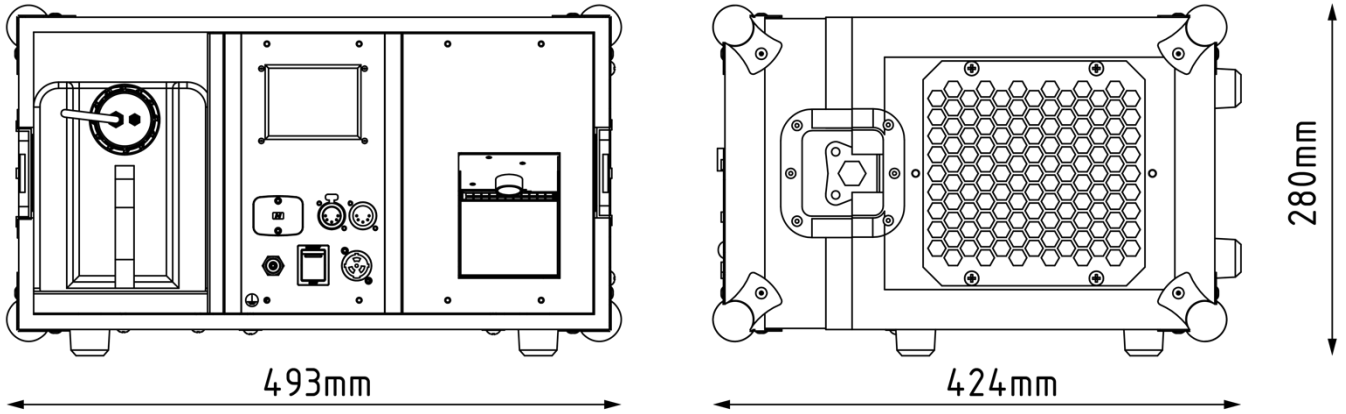





## 1. 前言

在操作本機器之前，請務必仔細詳閱本說明書然後請將本說明書放置在機器使用者可隨時查閱之處存放。此說明書包含如何安全的安裝及操作本機器以及說明所有在機器上的標示。如果您有任何操作上的問題，請立即聯繫當地的 Antari 經銷商尋求協助。

## 2. 安全注意事項

 <b>危險</b>	若不確實避免這些指示，可能導致嚴重人身傷害甚至死亡。
 <b>警告</b>	若不確實遵循這些指示，可能導致嚴重人身傷害甚至死亡。
 <b>注意</b>	若不確實注意這些指示，可能導致人身傷害甚至死亡，嚴重程度視情況而定。



### 危險

- 請務必使用正確電壓。如果使用錯誤電壓，可能會遭受危險的電擊燒傷或更嚴重的後果。
- 請務必將機器連結到有保護的電路，並確保有正確的接地，以避免觸電的危險。關於接地方式請參考第 21 附錄 I。
- 請勿在捆綁電源線的情況下使用，可能會發熱導致火災。
- 操作機器時請勿將機器對著人體、動物或火焰使用。



### 警告

- 請於堅固、平坦、穩定且通風良好的表面上使用機器。請勿遮蓋機器散熱部份，機器周邊至少應保留 50 公分的空間並確認附近沒有易燃性物質或可揮發性氣體。
- 請勿隨意拆卸、修理或改造機器，這可能會導致機器故障、損壞、觸電危險或造成火災。
- 本機器僅限有行為能力之成人或專業人員操作，不預期提供生理、感知、心智能力、經驗或知識不足者之使用者(包含孩童)使用本機器。
- 請勿在無人看管時讓機器運作，並於外出離去時確實關閉電源。
- 孩童應受監督，以確保孩童不能操作或嬉戲玩本機器。
- 請勿將機器倒放或傾斜使用，可能導致機器動作不正常或損壞。
- 請將液體存放在室內孩童無法取得之處，保持通風及避免陽光直射。如果有觸碰眼睛或誤食機器，請立即尋求醫生的協助。



### 注意

- 本機器無防水設計，請隨時保持機器乾燥，嚴禁將其潑水、浸水、淋雨或放在潮溼的環境。
- 在插入電源插座前，請確認電源插座無損壞或鬆動。
- 若電源線損壞，必須使用原廠電源線或組件進行更換，否則將導致保固無效。
- 請在使用機器之前，先填裝好煙霧水，避免機器幫浦空轉過熱造成損害。機器在搬運前或使用完畢後，請清空油桶。
- 在運輸本機器前，請確認機器的油箱已清空並且包裝完整。(建議使用原廠包裝)
- 本產品僅限室內使用。
- 請勿在電壓不穩定的地區使用本機器。

- 如果機器出現異常聲音或有任何不正常現象時，請立即停止工作，將電源關閉及拔下機器電源線，並請聯繫當地的 Antari 經銷商尋求協助。
- 請勿觸碰機器內部運轉零件。
- 只能使用原廠建議或販售之配件。
- 請確認機器不在使用的狀態下電源已關。如果長時間不使用機器，請拔掉電源線。
- 關閉機器時，將控制開關轉到關閉的位置，然後再將插頭從插座拔除。
- 拔除電源線時，請抓住插頭不是電線。
- 在保養及清潔前，請把電源線從插座拔除。
- 在電線或插座有損毀、機器故障或有掉落或損壞的情形發生時，請勿操作機器。請將機器送回最近的維修站，做檢查、維修及電源或機械的調整。
- 為確保機器的使用壽命，請使用 Antari 原廠製造之煙霧水，勿使用其它非 Antari 原廠製造煙霧水或添加劑，否則可能會導致電熱管阻塞和故障。

在使用本機之前，請詳細閱讀機器上的警語標示，說明如下：

**CAUTION! 注意!**

NEVER ADD FLAMMABLE SUBSTANCES. 切勿添加易燃物質。

**WARNING! 警告!**

DISCONNECT POWER BEFORE CHANGING FUSE. 更換保險絲前請務必斷開電源

USE ONLY WITH ADULT SUPERVISION. 僅在成人監督下使用

DO NOT OPERATE WITHOUT LIQUID. 請勿在沒有液體的情況操作本機台

FOR INDOOR USE ONLY. KEEP DRY. 僅限室內使用。請保持乾燥

NO USER SERVICEABLE PARTS INSIDE. 內部無使用者需維修之零配件

### 3. 包裝內容與檢查

在收到機器後，請立即小心地打開包裝紙箱，檢查所有內容，確認您所購買的機型及配件。如果有任何部件因運輸過程出現損壞或缺少，請立即連絡經銷商，並以原包裝退回檢查。

#### 3.1 包裝內容

- 1 台 F-6 煙霧機
- 1 條 Neutrik powerCON 電源線
- 1 本 說明書或掃描機身 QR CODE

#### 3.2 選配說明

品項	描述
ES-W-DMX	無線 DMX 接收器
WTR-110	無線控制器組(W-2 無線發射器/無線接收器)

## 4. 機器訊息

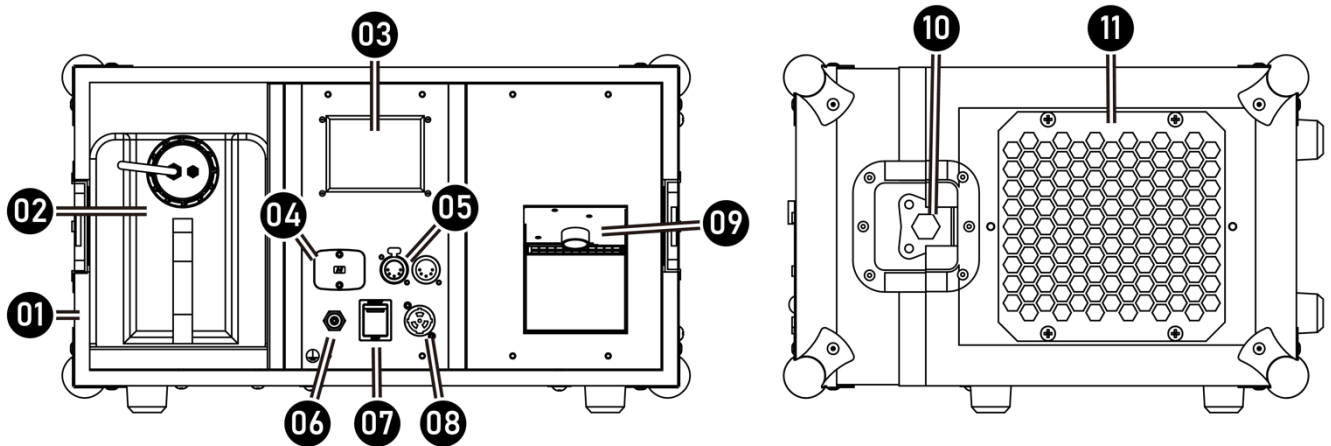

01. 飛行箱	07. 二合一電源&斷路器開關
02. 五公升油桶	08. Neutrik powerCON Chassis 連接頭
03. 觸控式液晶面板	09. 噴煙口
04. 擴充槽	10. 飛行箱鎖扣
05. XLR 5-Pin 連接頭(DMX)	11. 散熱網
06. 油管連接頭	

## 5. 技術標籤資訊

使用本機器前，請詳閱技術標籤上的訊息

1. 機器型號	5. 斷路器/保險絲
2. 工作電壓	6. 說明書 QR CODE
3. 頻率	7. 機器流水序號
4. 瓦特數	

## 6. 煙霧水

	<b>危險</b>	將液體加入機器之前，請務必先拔除電源線。請勿添加易燃液體。如果發現液體流入機器內部，請洽 Antari 原廠或其經銷商尋求協助。
--	-----------	--

- 僅能使用 Antari 原廠製造之煙霧水，不可混用或稀釋。若因保存不當而變質或使用非原廠煙霧水，將可能造成電熱管堵塞而導致機器故障。
- 本機器是使用專屬的煙霧水做測試與校正來取得最佳的效能
- 如需更換另一種液體，請在使用前，先將油桶中的液體清空，以避免混合。
- 僅能使用 Antari 原廠製造之香精，並依照原廠建議比例添加(原廠建議比例為 1:1000)，如果使用非原廠的香精或比例添加有誤，將可能造成電熱管阻塞而導致機器故障。
- 如果使用非原廠製造之煙霧水或香精而導致煙霧機損壞將不在保固範圍內。

## 7. 設定與手動操作說明



警告

機台掉落可能會造成嚴重傷害，請確保本機台安裝牢固且不會掉落。

- 步驟1. 將機器平放在堅固、平坦、穩定且通風良好的表面上，機器周圍至少應保留 50 公分的空間並確認附近沒有易燃性物質或可揮發性氣體。
- 步驟2. 使用 ANTARI 原廠專用煙霧水注入機器所附的油桶，並注意不要折到油管。
- 步驟3. 將機器連接電源，連接之前，確認機器背後技術標籤上所標示要求功率，是否與電源插座相符。
- 步驟4. 啟動機器電源後，使機器開始加溫。機器加溫到可工作溫度大約需要 1 分鐘。當機器達到工作溫度時”100%”(螢幕左上角)，表示機器已經準備好可進行操作。
- 步驟5. 欲手動模式啟動噴煙，按下面板上的”手動”；調整需要的輸出量及風扇速度按下”開始”然後再按一次停止噴煙
- 步驟6. 定時模式啟動噴煙，按下面板上的”定時”；調整需要的[時間間隔]、[噴煙時間]、[輸出量]及[風扇速度]按下開始，然後再按一次停止噴煙
- 步驟7. 按下”DMX”，然後根據需求設定
- 步驟8. 按下”Menu”，然後根據需求設定
- 步驟9. 需關閉本機時，請確認機器已停止運轉，再將電源開關關閉即可，長時間不使用時請移除電源線。

## 8. 控制設定





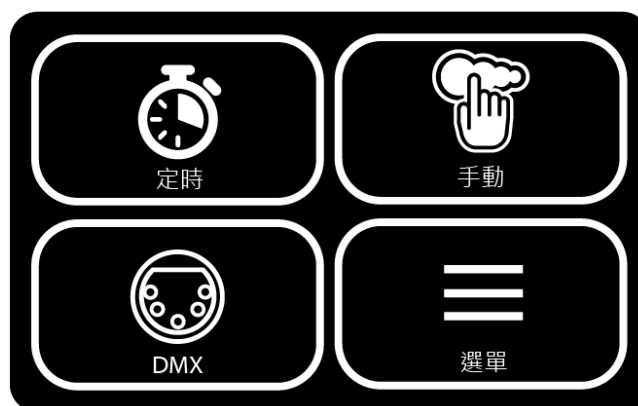

F-6 煙霧機可以使用下列操作模式，機器每次接受一種訊號。當同時使用多種訊號時機器將根據原廠內建訊號的優先順序來進行工作：

- 手動控制
- 定時控制
- DMX512
- W-DMX
- 無線控制

### 8.1 控制面板說明





圖標	操作方式	動作
	按	確認選擇
	按	調整數值
	按	回到上一頁
	按	啟動
	按	停止
	按	進入設定
 (綠色背景)	N/A	正在運作的模式

## 8.2 選單說明

主選單	選項	設定值	
定時	間隔時間	1 - 999 秒	
	啟動時間	1 - 999 秒	
	定時輸出量	1 - 100%	
	風扇速度	20 - 100%	
手動	手動輸出量	1 - 100%	
	風扇速度	20 - 100%	
DMX	地址	001-512	
	通道模式	3 種模式	
	W-DMX 電源	開啓 / 關閉	
	W-DMX 重置	解除配對	
選單	資訊	軟體版本	
	設定	LCD 背光	高/中/低/自動關閉
		自動啟動	開啓 / 關閉
		語言選項	English / 中文 / 日本語
		無線遙控器配對	配對/取消配對
自我清潔模式	倒數 180 秒		

## 9. 機器狀態

## 9.1 機器狀態說明

面板畫面	說明
AC 頻率	電源頻率
Antari F-6 噴煙就緒	噴煙就緒 (螢幕左上角顯示 100%) W-DMX 連接狀態  WDMX (螢幕右上角圖示，詳細說明請參考 12.3) Wireless 顯示 
手動輸出量 100 %	手動噴煙執行中
間隔時間 1 - 999 秒 啟動時間 1 - 999 秒	定時噴煙執行
DMX512 地址 xxx	DMX 執行中
自我清潔模式	倒數 180 秒後進入休眠 (DMX 移除時)
機器加熱中 10 %	加熱中 0 - 100% (螢幕左上角)
機器過熱	電熱管過熱
加熱器故障	電熱管溫度異常
溫度線斷開	溫度線斷開
溫度線反接	溫度線反接
電壓錯誤	電壓錯誤

\*\*控制面板出現警告的訊息，請立即停止操作機器並關閉電源之後，請與當地的 Antari 經銷商尋求協助。

## 10. DMX 說明

### 10.1 DMX 說明

本機提供一個 XLR 5-PIN 的 DMX 連接頭。下為 PIN 的接點說明：

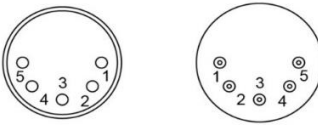
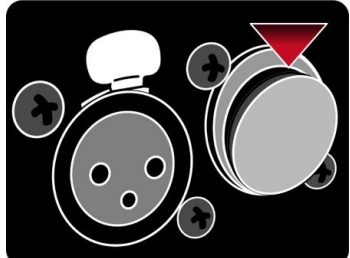
 <p>5 Pin XLR</p> <table border="1"> <thead> <tr> <th>Pin</th> <th>Function</th> </tr> </thead> <tbody> <tr> <td>1</td> <td>Ground</td> </tr> <tr> <td>2</td> <td>Data-</td> </tr> <tr> <td>3</td> <td>Data+</td> </tr> <tr> <td>4</td> <td>NA</td> </tr> <tr> <td>5</td> <td>NA</td> </tr> </tbody> </table>	Pin	Function	1	Ground	2	Data-	3	Data+	4	NA	5	NA	<p>** DMX IN 連接頭上有一個保護蓋，操作前，請用手指撥開即可將其取下。</p> 
Pin	Function												
1	Ground												
2	Data-												
3	Data+												
4	NA												
5	NA												

### 10.2 DMX 通道功能

本機提供二種 DMX 通道及三種模式可供選擇，請參考下方表單。

通道模式		DMX 數值範圍	功能
通道 1	煙霧輸出量	0-5	關閉
		6-255	1-100%
通道 2	風扇速度	0-50	20%
		51-255	21-100%
模式		功能	
模式 1	1 通道	通道 1 和通道 2 同步輸出	
模式 2	1 通道	通道 1 和風扇固定 100%	
模式 3	2 通道	通道 1 煙霧輸出量和通道 2 風扇速度	

## 11. RDM 功能

F-6 Fazer 煙霧機配有 RDM 功能，讓使用者可以經由 DMX 網路使用 RDM 功能進行機台的設定、監控、管理。請參考下表相關 RDM 支援參數；

GET Allowed	SET Allowed	Category	RDM Parameter ID's (Slot 21-22)	Value	Required
		NetworkManagement 網路管理	DISC_UNIQUE_BRANCH	0x0001	○
				0x0002	○
				0x0003	○
○		RDM Information RDM 資訊	QUEUED_MESSAGE	0x0020	
○			STATUS_MESSAGES	0x0030	
○			SUPPORTED_PARAMETERS	0x0050	○
○			PAPAMETER_DESCRIPTION	0x0051	○
○		Product Information 產品資訊	DEVICE_INFO	0x0060	○
○			PRODUCT_DETAIL_ID_LIST	0x0070	
○			DEVICE_MODE_DESCRIPTION	0x0080	
○			MANUFACTURER_LABEL	0x0081	
○	○		DEVICE_LABEL	0x0082	
○			SOFTWARE_VERSION_LABEL	0x00C0	○
○	○	DMX512 Setup DMX512 設定	DMX_PERSONALITY	0x00E0	
○			DMX_PERSONALITY_DESCRIPTOR	0x00E1	
○	○		DMX_START_ADDRESS	0x00F0	○
○			SLOT_INFO	(0x0120)	
○			SLOT_DESCRIPTION	(0x0121)	
○			DEFAULT_SLOT_VALUE	(0x0122)	
○		Sensors 感應器	SENSOR_DEFINITION	0x020	
○	○		SENSOR_VALUE	0x0201	
○		Control 控制	DEVICE_HOURS	0x0400	
○	○		IDENTIFY_DEVICE	0x1000	○
○	○		POWER_STATE	0x1010	

## 12. ES-W-DMX 無線 DMX 說明(選配)

本機選購的無線 DMX 接收器可同時支援 CRMX 以及 W-DMX 協議

### 12.1 ES-W-DMX

這是一個無線 DMX 接收器

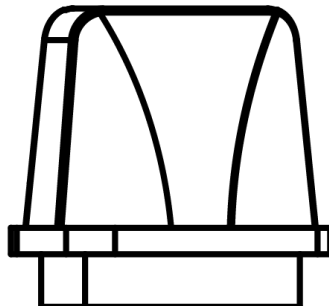

## 12.2 無線 DMX 接收器安裝說明

如果是後續採購無線 DMX 接收器，請按照下方說明進行安裝與配對。如果遇到任何困難與問題，請與當地的 Antari 經銷商尋求協助。



圖 1



圖 2

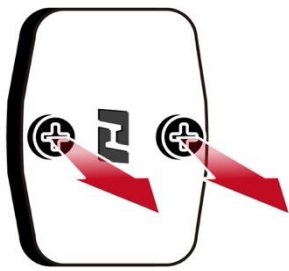

圖 3

1. 請看圖一，取下蓋子。
2. 請看圖二，取下後，你會看到一條白色的線，請拉出來接在 W-DMX 接收器上。
3. 請看圖三，將接收器鎖回去原本的地方即可使用。

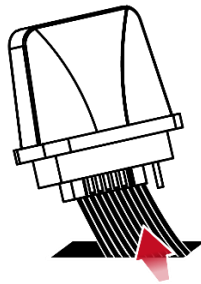
## 12.3 無線 DMX 連接狀態說明

請按照下列步驟，啟用此功能；

1. 進入 DMX 設定選單；
2. 按上下箭頭，找到[W-DMX 電源]，開啟 W-DMX 電源，然後就可在螢幕上看到目前狀態。

LCD 螢幕上所顯示的符號	無線 DMX 連結狀態
○ (綠燈)	無線 DMX 發射器已對頻，接收到 DMX 訊號
◎	無線 DMX 發射器已對頻，但沒有 DMX 訊號
◉	無線 DMX 發射器連接遺失 / 正在與發射器連接
● (紅燈)	沒有對頻任何無線 DMX 發射器

## 13. WTR-110 無線控制器(選配)

WTR-110 無線控制器包含一個 W-2 無線發射器及無線接收器，此為 F-6 Fazer 煙霧機的選購配件。若您採購的版本已含無線功能即已安裝至機器上，可直接使用。若是後續採購 WTR-110 無線控制器，請按照下方說明進行安裝與配對。如果遇到任何困難與問題，請與當地的 Antari 經銷商尋求協助。

### 13.1 W-2 無線發射器說明

- 發射器：使用 27A 12V 電池
- 收發距離：有效距離為 50 公尺，實際收訊狀況根據現場環境因素而有所不同。
- W-2 無線發射器配有 4 個按鈕，控制功能為：

按鈕	功能
[A] 鍵	啟動噴煙
[B] 鍵	關閉噴煙
[C] 鍵	增加煙霧輸出量
[D] 鍵	減少煙霧輸出量



W-2 無線發射器

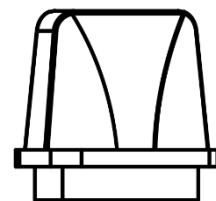

無線接收器

## 13.2 WTR-110 接收器安裝說明

如果是後續採購 WTR-110 無線控制器，請按照下方說明進行安裝與配對。如果遇到任何困難與問題，請與當地的 Antari 經銷商尋求協助。



圖 1



圖 2

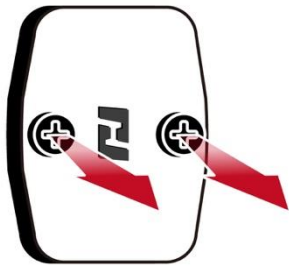

圖 3

1. 請看圖一，取下蓋子;
2. 請看圖二，取下後，你會看到一條白色的線，請拉出來接在無線接收器上;
3. 請看圖三，將接收器鎖回去原來的地方，然後按照 13.3 的步驟開始配對。

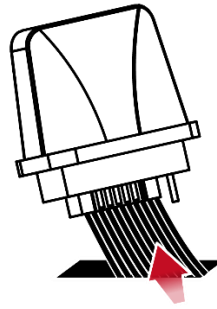
## 13.3 配對 & 取消配對

**步驟 1:** 機器必須在 Ready 的狀態，才能進行配對;

**步驟 2:** 按下[MENU]進入選單;

**步驟 3:** 按上下箭頭找到[無線遙控器配對];

**步驟 4:** 按下[配對]後，同時按下無線發射器的[A]鍵，進行配對;

**步驟 5:** 按下[取消配對]取消配對，成功後機器會自動重新開機。

## 14. 維護和保養



**危險**

維修保養之前，請務必拔除電源線！

- 隨時保持機器清潔，不要讓機器髒汙。
- 可以使用空氣壓縮機、吸塵器或軟刷除去機器上的灰塵。
- 機殼可使用濕布擦拭。
- 在存放或收起機器前，請確認機器完全冷卻，避免機器內部潮濕導致故障。
- 建議每月至少讓機器運轉一次，以保持機器處於最佳的性能和輸出條件。
- 機器上過多的灰塵、液體殘餘累積的髒汙會降低機器工作性能，導至散熱不良。

### 14.1 重置斷路器 (二合一電源開關)

此二合一開關結合電源和斷路器功能。請依照以下步驟重置斷路器;

步驟 1: 請將此二合一開關切到 OFF 的位置

步驟 2: 等待 60 秒

步驟 3: 再將此二合一開關切到 ON 的位置即完成重置

若重置斷路器後，依然跳掉的話，請與當地 Antari 經銷商聯繫，尋求協助。

**斷路器規格** 100-120V = 15A 250V

220-240V = 9A 250V

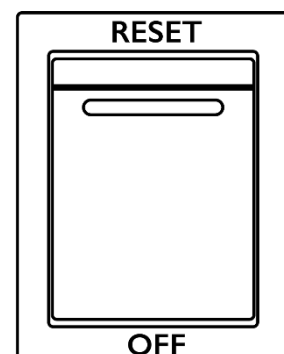

## 15. 技術規格

F-6 Fazer	
額定電壓	美規：AC 100-120V, 50/60Hz 12.5A 歐規：AC 220-240V, 50/60Hz 6.5A
額定功率	1450 瓦
加熱時間	約 1 分鐘
耗油量	12 毫升/分鐘 (100%輸出)
運作時間	7 小時(最大輸出量下)
油桶容量	5 公升 (1.32 加侖)
適用煙霧水	Antari FLG-5E 濃煙霧水
適用環境溫度	0°C – 40°C (32°F – 104°F)
控制方式	手動控制、定時控制、DMX 512、無線 DMX(選配)、無線控制(選配)
DMX 512 通道	2 個頻道
連接座	XLR 5-pin (DMX)、Neutrik powerCON (主電源)
隨附配件	無
選購配件	TIMO-W-DMX-PCBR 無線 DMX 接收器、WTR-110 無線控制器
尺寸	長 493 寬 424 高 280 公釐 (長 19.40 寬 16.69 高 10.59 英寸)
重量	17.2 公斤 (37.80 磅)

## 16. 機器尺寸圖

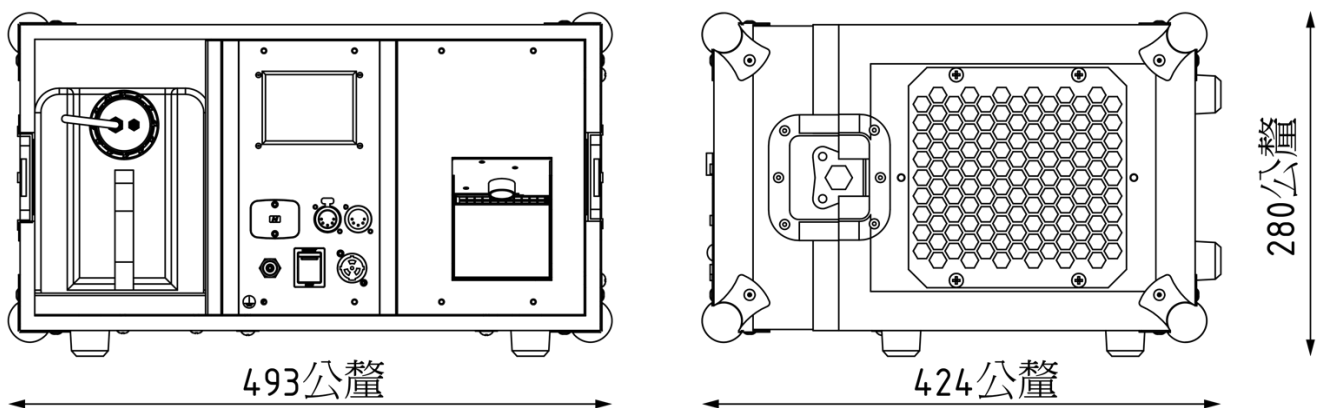

## 17. 保固聲明

本公司保證我們的商品在一年內沒有材料和製作缺陷。我們在本保證下的義務和責任僅限於在原廠或當地授權經銷商進行的維修或更換。我們對不當使用或用於非專門設計目的以外之用途不承擔任何責任。本保固不適用於以任何方式在原廠或當地授權經銷商外修理、改動或組裝的任何商品，以便我們判斷影響其性能，沒有受到誤用、疏忽或事故的影響，也沒有違反我們的任何商品操作印刷說明。本公司對於從我們這邊購買的商品不會允許也不對於使用、銷售或修理任何產品有關的任何類型的任何損失或損害承擔責任。

## Appendix I – Grounding Instruction

This appliance must be grounded. In the event of malfunction or breakdown, grounding provides a path of least resistance for electric current to reduce the risk of electric shock. This appliance is equipped with a cord having an equipment-grounding conductor and a grounding plug. The plug must be plugged into an appropriate outlet that is properly installed and grounded in accordance with all local codes and ordinances.

**DANGER** – Improper connection of the equipment-grounding conductor can result in a risk of electric shock. The conductor with insulation having an outer surface that is green with or without yellow stripes is the equipment-grounding conductor. If repair or replacement of the cord or plug is necessary, do not connect the equipment-grounding conductor to a live terminal. Check with a qualified electrician or serviceman if the grounding instructions are not completely understood, or if in doubt as to whether the appliance is properly grounded. Do not modify the plug provided with the appliance – if it will not fit the outlet, have a proper outlet installed by a qualified electrician.

This appliance is for use on a nominal 120 V circuit, and has a grounding plug that looks like the plug illustrated in sketch A in Figure. A temporary adaptor, which looks like the adaptor illustrated in sketches B and C, may be used to connect this plug to a 2-pole receptacle as shown in sketch B if a properly grounded outlet is not available. The temporary adaptor should be used only until a properly grounded outlet can be installed by a qualified electrician. The green colored rigid ear, lug, and the like, extending from the adaptor must be connected to a permanent ground such as a properly grounded outlet box cover. Whenever the adaptor is used, it must be held in place by the metal screw.

