

User Manual



ULTRADRIVE PRO DCX2496

Ultra High-Precision Digital 24-Bit/96 kHz
Loudspeaker Management System

Table of Contents

Thank you	2
Important Safety Instructions	3
Legal Disclaimer	3
Limited Warranty	3
1. Introduction	4
2. Control Elements	4
3. Quick Start.....	6
4. Menu Structure and Editing	6
5. Audio Connections	17
6. Applications	17
7. Specifications	30
8. Block Diagram.....	32
9. Menu Structure	33

Thank you

Thank you very much for expressing your confidence in BEHRINGER products by purchasing the ULTRADRIVE PRO DCX2496—our high-quality digital loudspeaker management system designed specifically for both live and studio applications.

EN Important Safety Instructions



Terminals marked with this symbol carry electrical current of sufficient magnitude to constitute risk of electric shock.

Use only high-quality professional speaker cables with ¼" TS or twist-locking plugs pre-installed. All other installation or modification should be performed only by qualified personnel.



This symbol, wherever it appears, alerts you to the presence of uninsulated dangerous voltage inside the enclosure - voltage that may be sufficient to constitute a risk of shock.



This symbol, wherever it appears, alerts you to important operating and maintenance instructions in the accompanying literature. Please read the manual.



Caution

To reduce the risk of electric shock, do not remove the top cover (or the rear section). No user serviceable parts inside. Refer servicing to qualified personnel.



Caution

To reduce the risk of fire or electric shock, do not expose this appliance to rain and moisture. The apparatus shall not be exposed to dripping or splashing liquids and no objects filled with liquids, such as vases, shall be placed on the apparatus.



Caution

These service instructions are for use by qualified service personnel only. To reduce the risk of electric shock do not perform any servicing other than that contained in the operation instructions. Repairs have to be performed by qualified service personnel.

1. Read these instructions.
2. Keep these instructions.
3. Heed all warnings.
4. Follow all instructions.
5. Do not use this apparatus near water.
6. Clean only with dry cloth.
7. Do not block any ventilation openings. Install in accordance with the manufacturer's instructions.
8. Do not install near any heat sources such as radiators, heat registers, stoves, or other apparatus (including amplifiers) that produce heat.

9. Do not defeat the safety purpose of the polarized or grounding-type plug. A polarized plug has two blades with one wider than the other. A grounding-type plug has two blades and a third grounding prong. The wide blade or the third prong are provided for your safety. If the provided plug does not fit into your outlet, consult an electrician for replacement of the obsolete outlet.

10. Protect the power cord from being walked on or pinched particularly at plugs, convenience receptacles, and the point where they exit from the apparatus.

11. Use only attachments/accessories specified by the manufacturer.



12. Use only with the cart, stand, tripod, bracket, or table specified by the manufacturer, or sold with the apparatus. When a cart is used, use caution when moving the cart/apparatus combination to avoid

injury from tip-over.

13. Unplug this apparatus during lightning storms or when unused for long periods of time.

14. Refer all servicing to qualified service personnel. Servicing is required when the apparatus has been damaged in any way, such as power supply cord or plug is damaged, liquid has been spilled or objects have fallen into the apparatus, the apparatus has been exposed to rain or moisture, does not operate normally, or has been dropped.

15. The apparatus shall be connected to a MAINS socket outlet with a protective earthing connection.

16. Where the MAINS plug or an appliance coupler is used as the disconnect device, the disconnect device shall remain readily operable.



TO BIND MUSIC GROUP BY ANY EXPRESS OR IMPLIED UNDERTAKING OR REPRESENTATION. THIS MANUAL IS COPYRIGHTED. NO PART OF THIS MANUAL MAY BE REPRODUCED OR TRANSMITTED IN ANY FORM OR BY ANY MEANS, ELECTRONIC OR MECHANICAL, INCLUDING PHOTOCOPYING AND RECORDING OF ANY KIND, FOR ANY PURPOSE, WITHOUT THE EXPRESS WRITTEN PERMISSION OF MUSIC GROUP IP LTD.

ALL RIGHTS RESERVED.

© 2013 MUSIC Group IP Ltd.

Trident Chambers, Wickhams Cay, P.O. Box 146, Road Town, Tortola, British Virgin Islands

LIMITED WARRANTY

For the applicable warranty terms and conditions and additional information regarding MUSIC Group's Limited Warranty, please see complete details online at www.music-group.com/warranty.

LEGAL DISCLAIMER

TECHNICAL SPECIFICATIONS AND APPEARANCES ARE SUBJECT TO CHANGE WITHOUT NOTICE AND ACCURACY IS NOT GUARANTEED. BEHRINGER, KLARK TEKNIK, MIDAS, BUGERA, AND TURBOSOUND ARE PART OF THE MUSIC GROUP (MUSIC-GROUP.COM). ALL TRADEMARKS ARE THE PROPERTY OF THEIR RESPECTIVE OWNERS. MUSIC GROUP ACCEPTS NO LIABILITY FOR ANY LOSS WHICH MAY BE SUFFERED BY ANY PERSON WHO RELIES EITHER WHOLLY OR IN PART UPON ANY DESCRIPTION, PHOTOGRAPH OR STATEMENT CONTAINED HEREIN. COLORS AND SPECIFICATIONS MAY VARY FROM ACTUAL PRODUCT. MUSIC GROUP PRODUCTS ARE SOLD THROUGH AUTHORIZED FULLFILLERS AND RESELLERS ONLY. FULLFILLERS AND RESELLERS ARE NOT AGENTS OF MUSIC GROUP AND HAVE ABSOLUTELY NO AUTHORITY

1. Introduction

To operate a loudspeaker system that consists of several speakers for the various frequency bands requires different input signals for the individual loudspeakers. This requires a frequency crossover network that divides the input signal into several frequency bands. For this purpose, the ULTRADRIVE PRO provides up to six outputs.

Multi-way speaker systems are used in many applications—including stereo systems, cinemas, discotheques and concert halls. Due to the high quality demands made by today's consumers, they can even be found in "simple" products such as TV sets. Why?

A single loudspeaker cannot reproduce the entire audible frequency spectrum with the same high quality. If it is connected to a crossover network and only has to reproduce a limited frequency band, the quality will improve considerably in terms of frequency response and dispersion pattern. This also reduces intermodulation distortion in the treble range (due to the diaphragm displacement produced by bass frequencies).

- ◆ This manual first describes the terminology used, so that you understand the unit and its functions. Please read the manual carefully and keep it for future reference.

1.1 Before you get started

1.1.1 Shipment

The ULTRADRIVE PRO was carefully packed in the factory to guarantee safe transport. Nevertheless, we recommend that you carefully examine the packaging and its contents for any signs of physical damage, which may have occurred during transit.

- ◆ If the unit is damaged, please do NOT return it to us, but notify your dealer and the shipping company immediately, otherwise claims for damage or replacement may not be granted.

1.1.2 Initial operation

Be sure that there is enough space around the unit for cooling purposes and, to avoid over-heating, please do not place the DCX2496 on high-temperature devices such as radiators or power amps.

- ◆ Blown fuses must only be replaced by fuses of the same type and rating!

The console is connected to the mains via the supplied cable. It meets the required safety standards.

- ◆ Please make sure that all units have a proper ground connection. For your own safety, never remove or disable the ground conductor from the unit or the AC power cord.

1.1.3 Warranty

Please take time to fill out and return the warranty card within 14 days after the date of purchase. Alternatively, you can use our online registration option available on the world wide web (behringer.com). You will find the serial number on the rear of your mixing console.

1.1.4 Online registration

Please register your new BEHRINGER equipment right after your purchase by visiting <http://behringer.com> and read the terms and conditions of our warranty carefully.

Should your BEHRINGER product malfunction, it is our intention to have it repaired as quickly as possible. To arrange for warranty service, please contact the BEHRINGER retailer from whom the equipment was purchased. Should your BEHRINGER dealer not be located in your vicinity, you may directly contact one of our subsidiaries. Corresponding contact information is included in the original equipment packaging (Global Contact Information/European Contact Information). Should your country not be listed, please contact the distributor nearest you. A list of distributors can be found in the support area of our website (<http://behringer.com>).

Registering your purchase and equipment with us helps us process your repair claims more quickly and efficiently.

Thank you for your cooperation!

1.2 The user's manual

The user's manual is designed to give you both an overview of the controls, as well as detailed information on how to use them. You find a detailed short-description of the most important functions in chapter 3.

2. Control Elements

2.1 Front panel

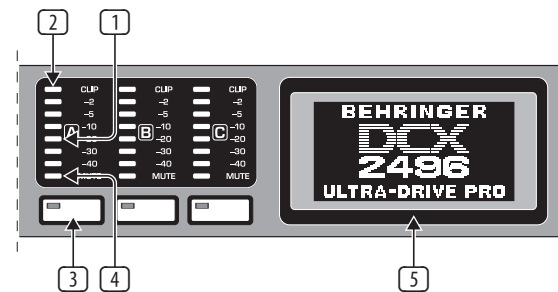

Fig. 2.1: Input LEDs and display

- 1 The DCX2496 features three 6-segment LED displays (plus CLIP and MUTE LED) for precise level adjustment of input signals A-C.
- 2 If the input stage is overdriven, the **CLIP** LED will indicate that the signal is distorting.
- 3 The bottom LED (#8) is the **MUTE** LED (red), which illuminates when the respective input is muted (see chapter 4.6).
- 4 These are the input channel buttons, which allow you to activate specific functions from the selected menus (e.g. MUTE). Additionally, you can use these buttons to call up the IN A/B/C menus (see chapter 4.3).
- 5 The **DISPLAY** shows all the menus available for preset editing.

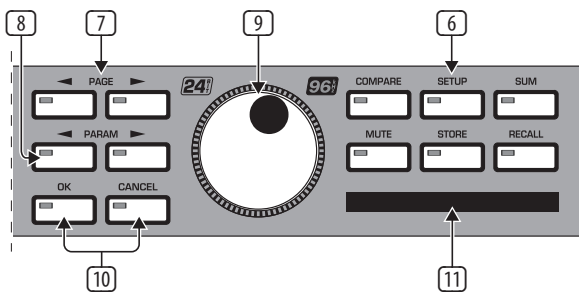

Fig. 2.2: Menu buttons and data wheel

- 6 Use these buttons to call up the DCX2496's menus (e.g. SETUP, RECALL, etc.). The only exception is the **COMPARE** button, which allows you to compare the edits made with the previously selected presets. When COMPARE is active, no value changes can be entered.
 - 7 The **PAGE** buttons select single pages from one menu.
 - 8 Individual parameters can be selected with the **PARAM** buttons.
 - 9 The data wheel allows you to edit the selected parameters.
 - 10 With the **OK** and **CANCEL** buttons you can either confirm or cancel any settings made.
 - 11 The PCMCIA card slot is used to exchange files between your DCX2496 and a PC card with a flash memory.
- ◆ Please only use "5 V ATA Flash Card" PC cards (min. 4 MB). Even though the memory capacity of the medium can be selected freely, you can only store a maximum of 60 presets.

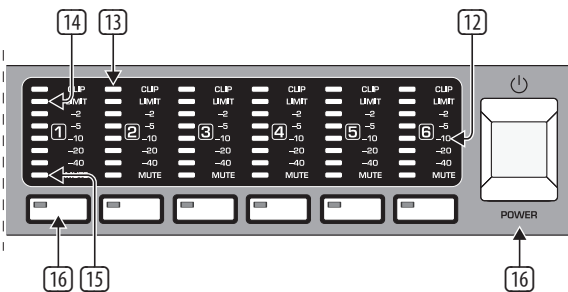

Fig. 2.3: Output LEDs

- 12 Outputs 1-6 each have a six 5-segment LED display (plus MUTE, CLIP and LIMIT LED) showing the respective output levels.
- 13 Like the input stages, the output stages should not be overdriven, i.e. the **CLIP** LED should not illuminate.
- 14 The **LIMIT** LED illuminates when the limiter for the corresponding output has been activated and is operating.
- 15 The bottom LED indicator (#8) is the **MUTE** LED, which illuminates as soon as the corresponding output is muted (see chapter 4.6).
- 16 Output channel buttons, with which you can enter the outputs 1-6 (see chapter 4.5) or mute or reactivate individual outputs in MUTE mode (4.6).
- 17 Use the **POWER** switch to put your DCX2496 into operation. The **POWER** switch should always be in the "Off" position when you are about to connect your unit to the mains.

2.2 Rear panel

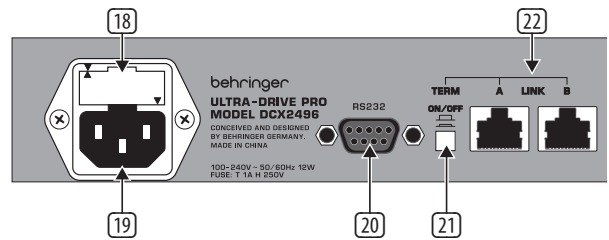

Fig. 2.4: Mains connector and RS-232/RS-485 interface

- 18 This is the **FUSE HOLDER** of your DCX2496. Blown fuses must be replaced by a fuse of the same type and rating.
 - 19 The mains connection is an **IEC** receptacle. An appropriate power cord is included.
 - 20 The 9-pin **RS-232** interface allows you to connect your DCX2496 to a computer. This enables you to save and load files, update the DCX2496 operating software, or remotely control one or several ULTRADRIVE PRO units from a PC. Free editor software can be downloaded at behringer.com.
 - 21 When you have daisy-chained several ULTRADRIVE PRO via the **LINK** connectors (see 22), please press the **TERM** switch on the first and last unit of the chain, to avoid data reflections and transmission errors.
- ◆ **General rule:** As soon as one device in the chain is integrated into the system via only one of the **LINK** connectors, the **TERM** switch must be pressed (**ON**). Detailed information on this can be found in chapter 4.2.6 "Miscellaneous".
- 22 Use the **LINK** connectors A and B (**RS-485** network interface) and a commercially available network cable to daisy-chain several ULTRADRIVE PROs.

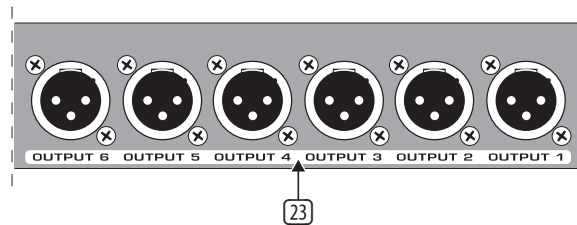

Fig. 2.5: Output connectors

- 23 Balanced **XLR** output connectors for output channels 1-6. Connect your power amps here.

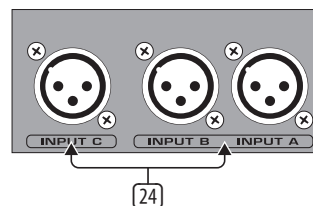

Fig. 2.6: Input connectors

- 24 Balanced **XLR** input connectors A, B and C are used for connecting input signals. Input A can also be used for digital AES/EBU input signals. Input C can be used for line signals or for connecting a measuring microphone. If **AUTO ALIGN** has been enabled in the **SETUP** menu (see chapter 4.2.2), input C will be set for mic levels automatically. Additionally, phantom power for the measuring microphone will be switched on.

3. Quick Start

This chapter is for those who cannot wait to use their new DCX2496 in a practical application. You will find a description of how you can explore your DCX2496 and its versatile and intuitive features below. This chapter is just a starting point for future excursions. So, please read the entire user's manual to take full advantage of all your DCX2496's features and functions.

Please work your way through the following six chapters (3.1 to 3.6), one after the other. Here we go!

3.1 Selecting an output configuration

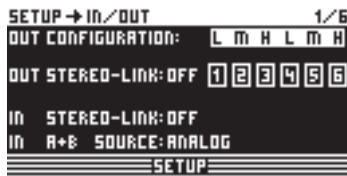

Fig. 3.1: Setup → In/Out

Press the SETUP button to call up the SETUP menu. On the first menu page, select an output configuration (**OUT CONFIGURATION**) to determine which outputs are used for which frequency ranges. One mono and three stereo configurations are available.

The mono configuration allows you to split the input signal into six different frequency ranges. The stereo configurations allow a maximum of three different frequency ranges per stereo side. The abbreviations L, M and H stand for Low, Mid and High Speaker. For more information see chapter 4.2.1 "IN/OUT".

3.2 Setting crossover frequencies

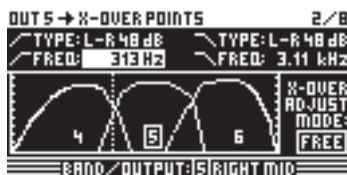

Fig. 3.2: Out → X-Over Points

In order to assign dedicated frequency bands to the output channels, you have to define the crossover frequencies (X-Over) for each of them. The crossover frequencies determine the upper and lower limits of a frequency band, which allows you to clearly separate the outputs from each other in terms of frequency.

Press the corresponding OUT button (1-6) and select menu page 2/8 using the PAGE buttons. With the parameters **FREQ** and **TYPE** you can define the slope of the crossover frequency and also select a filter type. When the parameter X-OVER ADJUST MODE is set to "LINK", any changes to the crossover frequency will also shift the neighboring frequency ranges. For more information see chapter 4.5.2 "X-OVER POINTS".

3.3 Muting input/output channels (Mute)



Fig. 3.3: Mute → Select

Press the MUTE button to enter the MUTE menu. Here you can mute the inputs and outputs of the DCX2496. On this page you can mute or activate individual channels by pressing the channel buttons (IN A/B/C and OUT 1-6), or all inputs/outputs by pressing the PARAM and OK or CANCEL buttons. Thus, you can monitor each frequency band, either individually or together with a neighboring band, to allow perfect editing of the isolated frequency range. To quit the MUTE menu press MUTE a second time. For more detailed information see chapter 4.6 "MUTE menu".

3.4 Storing presets



Fig.: 3.4: Store → Internal/Card

Use the STORE button to save your presets. In this menu you can store either in the internal memory (INT) or on a PC card (CARD). More information on the STORE function can be found in chapter 4.8 "STORE menu".

3.5 Recalling presets



Fig. 3.5: Recall → Internal/Card

Press the RECALL button to load presets from the internal memory or a memory card. Select either **INT** or **CARD** (PCMCIA memory card), then enter the preset you wish to recall. We included some typical presets, which you can use as a basis for your own applications. For further information see chapter 4.7 "RECALL menu".

3.6 Restoring the factory presets

If you wish to restore the ULTRADRIVE PRO's factory presets, press and hold both PAGE buttons on the front panel switching on the unit. The DCX2496 prompts you to confirm (OK) or CANCEL. Press OK to erase the internal memory and restore the factory presets.

♦ Please note that restoring the factory presets will irrevocably erase all edited presets.

4. Menu Structure and Editing

This chapter describes all functions, operating steps and parameter pages in full detail. While working with your DCX2496, please keep the user's manual on hand, and use it as a reference in case of problems.

4.1 General operating structure and display presentation

When you switch on your ULTRADRIVE PRO DCX2496, the display shows a graphic with the current routing of the unit, i.e. how inputs and outputs are linked to each other.

Use the buttons to the left of the output LED displays (SETUP, MUTE etc.) to enter the various menus. Most of them include several pages, which you can select with the PAGE buttons. The PARAM button selects individual parameters from one page, the data wheel edits them. Confirm new settings with OK, or cancel your selection with CANCEL. This operating structure is the same for all menus so it will not be repeated in each section of the manual.

The menu name is shown at the top-left of the display. Next to this, and separated by an arrow, is the name of the current page (e.g. SETUP → IN/OUT). The page number of the corresponding menu is shown on the right-hand side (e.g. 1/6 = page 1 of 6).

The bottom line also shows the menu name (e.g. SETUP). For buttons IN A-C and OUT 1-6 (below the input/output LED displays), the menus for the corresponding inputs/outputs are listed (IN A, OUT 3 etc.). In addition, the output display also indicates the name of the output (e.g. SUBWOOFER, RIGHT MID etc.).

4.2 SETUP menu

Use the SETUP menu to make basic adjustments necessary for the operation of your ULTRADRIVE PRO. Press the SETUP button to display the first page of this menu.

4.2.1 IN/OUT

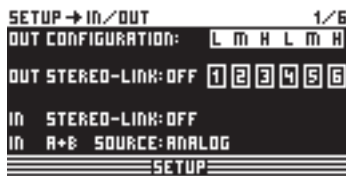

Fig. 4.1: Setup → In/Out

The parameter **OUT CONFIGURATION** selects the general operating mode; in MONO mode input A is the preset signal source for all outputs. In STEREO mode, three configurations are available. Please use inputs A and B in these modes. The display shows the OUT channels (L = LOW, M = MID and H = HIGH).

The stereo 3-way configuration LMHLMH has input A routed to outputs 1, 2 and 3, and input B routed to outputs 4, 5 and 6. The stereo 3-way configuration LLMMHH routes input A to outputs 1, 3 and 5, and input B to outputs 2, 4 and 6. The 2-way configuration LHLHLH uses all three inputs; here, A can be routed to outputs 1 and 2, B to outputs 3 and 4, and C to outputs 5 and 6. This application is used for 3 x 2-way speaker systems or triple bi-amping (see chapter 6.3).

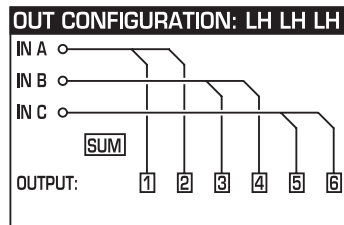
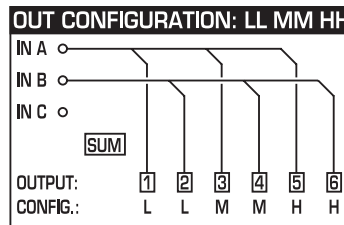
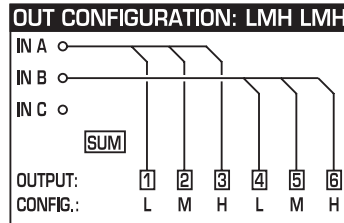
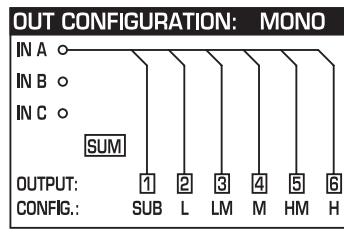

Fig. 4.2: Output configuration

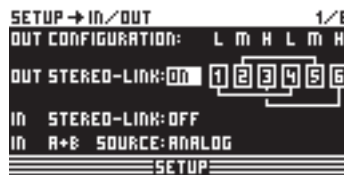

Fig. 4.3: Setup → In/Out

With the **OUT STEREO-LINK** function you can determine whether processing with EQs, limiter, etc. is effective on the linked outputs, or whether the settings for each output can be made independently. When this function is enabled (ON), linking several outputs to each other, the display will show small connecting lines between the individual outputs.

The following link options (output configurations) are available:

1. MONO (no stereo links)

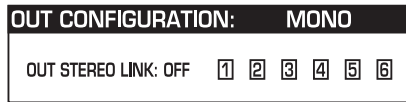

Fig. 4.4: Output configuration MONO

2. L(1) M(2) H(3) L(4) M(5) H(6)

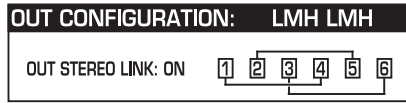

Fig. 4.5: Output configuration LMHLMH

Link: L(1) > L(4) / M(2) > M(5) / H(3) > H(6)

3. L(1) L(2) M(3) M(4) H(5) H(6)

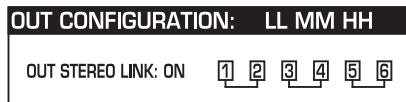

Fig. 4.6: Output configuration LLMMHH

Link: L(1) > L(2) / M(3) > M(4) / H(5) > H(6)

4. L(1) H(2) L(3) H(4) L(5) H(6)

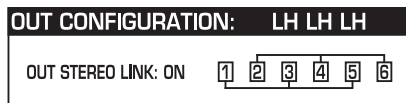

Fig. 4.7: Output configuration LHLHLH

Link: L(1) > L(3) > L(5) / H(2) > H(4) > H(6)



Fig. 4.8: Setup => In/Out

When Out Stereo Link is enabled, the unit warns you that all settings for the linked outputs will be lost, because they will be overwritten with the values of the output to be selected.

Any further changes to the parameters of a specific output will be transferred directly to the linked output. However, any edits made to a LONG DELAY value (see chapters 4.2.2 and 4.5.5) will not be transferred to the other output. This parameter can be adjusted specifically for each output. SHORT DELAY settings (see chapters 4.2.2 and 4.5.5) will be transferred as long as Out Stereo Link is on.

◆ In the MONO configuration, the Out Stereo Link function cannot be activated.

OUT Configuration	MONO 123456	LINK-Activation
OUT Stereo Link	OFF	not available
SHORT Delay Link (Chassis)	1 → 2 → 3 → 4 → 5 → 6 Sb → L → LM → M → HM → H	activated by enabling "OUT STEREO-LINK" on SETUP-page 1/6
LONG Delay Link (Loudspeakers)	1 → 2 → 3 → 4 → 5 → 6 Sb → L → LM → M → HM → H	activated by enabling "LINK" on OUT-page 8/8

OUT Configuration	LMH LMH 123 456	LINK-Activation
OUT Stereo Link	1 → 4 2 → 5 3 → 6 L → L M → M H → H	activated by enabling "OUT STEREO-LINK" on SETUP-page 1/6
SHORT Delay Link (Chassis)	1 → 4 2 → 5 3 → 6 L → L M → M H → H	activated by enabling "OUT STEREO-LINK" on SETUP-page 1/6
LONG Delay Link (Loudspeakers)	1 → 2 → 3 4 → 5 → 6 L → M → H L → M → H	activated by enabling "LINK" on OUT-page 8/8

OUT Configuration	LL MM HH 12 34 56	LINK-Activation
OUT Stereo Link	1 → 2 3 → 4 5 → 6 L → L M → M H → H	activated by enabling "OUT STEREO-LINK" on SETUP-page 1/6
SHORT Delay Link (Chassis)	1 → 2 3 → 4 5 → 6 L → L M → M H → H	activated by enabling "OUT STEREO-LINK" on SETUP-page 1/6
LONG Delay Link (Loudspeakers)	1 → 2 → 3 4 5 → 6 L → L M → M H → H	activated by enabling "LINK" on OUT-page 8/8

OUT Configuration	LH LH LH 12 34 56	LINK-Activation
OUT Stereo Link	1 → 3 → 5 2 → 4 → 6 L → L → L H → H → H	activated by enabling "OUT STEREO-LINK" on SETUP-page 1/6
SHORT Delay Link (Chassis)	1 → 3 → 5 2 → 4 → 6 L → L → L H → H → H	activated by enabling "OUT STEREO-LINK" on SETUP-page 1/6
LONG Delay Link (Loudspeakers)	1 → 2 3 → 4 5 → 6 L → H → L H → L → H	activated by enabling "LINK" on OUT-page 8/8

Tab. 4.1: Survey of all OUT LINK configurations



Fig. 4.9: Setup => In/Out

The inputs can also be linked using the parameter **IN STEREO LINK**. Thus, all settings of one input can be transferred to another input, or to all inputs.



Fig. 4.10: Setup => In/Out

When this function is On, the display provides a warning note that shows both the new link to be activated and the name of the inputs that will be overwritten (black field). Use the data wheel to edit the link to be activated (black field). The values of input A will be transferred to the following inputs.

Possible setting				
Newlink	OFF	A + B	A + B + C	A + B + C + SUM
Overwritten settings	(empty)	B	B+C	B+C+SUM

Tab. 4.2: In Stereo Link

When you edit a setting of any input, while a link is activated, all edits are directly transferred to the linked inputs. In the case of the IN STEREO LINK function, this also includes the DELAY values (see chapter 4.3.2).

Use the parameter **IN A + B SOURCE** to select the type of input signals: ANALOG or AES/EBU (digital: via input A only).

4.2.2 DLY-CORR./AUTO-ALIGN



Fig. 4.11: Setup → Dly-Corr./Auto-Align

As the speed of sound depends on the air temperature, the parameter **DELAY CORRECTION** on this SETUP page can be used to adjust the DCX2496 to the ambient temperature, ensuring proper delay characteristics at all times. The available value range is from -20°C to 50°C (-4°F to 122°F) and will be taken into account only as long as DELAY CORRECTION is ON.

With the **AUTO ALIGN** function you can delay the output signal automatically by a certain amount, so as to eliminate phase cancellations caused by speaker alignment. For example, when the diaphragms of several speakers are not in the same phase it leads to cancellations due to arrival time differences. Identical signals are radiated from different positions, so that wave crests coincide with wave troughs. If only one of these signals is delayed, this misalignment can be compensated.

If the arrival time differences are smaller, a short signal delay will be enough to eliminate them (SHORT DELAY). However, if the speaker cabinets are placed several meters away from each other, not only can phase cancellations occur but so can audible run-time differences. To remove these, you'll have to use considerably higher delay values (LONG DELAY). The LONG DELAY calculation, however, works only with a minimum distance of four meters.

If, for example, a speaker is connected with incorrect polarity, AUTO ALIGN will detect and—if POLARITIES is on—correct this error automatically.

Use the parameters **SHORT DELAY**, **LONG DELAY** and **POLARITIES** for the automatic correction of output signals. As soon as at least one parameter is set to YES, pressing OK will take you to another sub-menu. If not (all parameters set to NO), you will be warned that the process cannot be executed.



Fig. 4.12: Setup → Dly-Corr./Auto-Align

In the AUTO-ALIGN sub-menu you can mute or open all outputs. Be sure that at least two outputs are open (UNMUTE OUTPUTS TO ALIGN), otherwise no delay values can be calculated, and a warning message will be displayed.



Fig. 4.13: Setup → Dly-Corr./Auto-Align

If at least two or more outputs have been opened and OK has been pressed, the cursor will jump to ADJUST NOISE LEVEL and you can hear some test noise. Use the data wheel to adjust the test noise. The level will be read at the outputs. Press OK to trigger the measuring process. The DCX2496 calculates the run-time differences, phase shift and polarity. The OUTs are automatically adjusted to the optimum delay values calculated. This process cannot be executed if the test noise level is too low.



Fig. 4.14: Setup → Dly-Corr./Auto-Align

4.2.3 COPY

Use the COPY function to copy parameter settings to other pages. For example, you can transfer the EQ or gain settings from one channel to another, which saves you a lot of time.

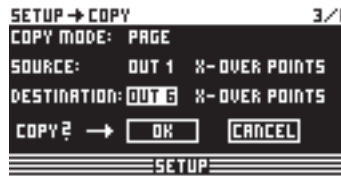

Fig. 4.15: Setup → Copy

The parameter **COPY MODE** determines whether only single pages (PAGE) or the complete channel settings (WHOLE CHANNEL) will be copied. Select PAGE mode with the PARAM button and then select the source channel (**SOURCE**) plus the SOURCE PAGE to be transferred to another channel. If you select just one page, the channel to be overwritten (DESTINATION PAGE) will appear automatically under the parameter **DESTINATION**. Please enter the channel to which the data should be copied to (DESTINATION CHANNEL).

Both the source and destination Channel can be selected using the data wheel or by pressing the corresponding channel button (IN A-C, OUT 1-6 and SUM).



Fig. 4.16: Setup → Copy

EN

Press OK or CANCEL to subsequently copy further pages in the same way.

- ◆ Only similar pages with identical parameters can be copied. If you select a SOURCE PAGE that is not available in the DESTINATION CHANNEL, the display will read NOT AVAILABLE under DESTINATION PAGE.

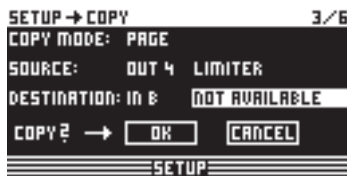

Fig. 4.17: Setup → Copy

If you set COPY MODE to WHOLE CHANNEL, you can copy the complete channel settings to another channel. Use SOURCE to select the channel to be copied (SOURCE-CHANNEL), then define the channel to be overwritten (DESTINATION). The process is the same as in PAGE mode.

So-called “cross copying” (copying of different channels, for example output 1 to input A), allows the copying of only those pages that can be transferred 1:1 to another channel. Any other pages will not be overwritten.

Previously locked pages (see chapter 4.2.4) cannot be overwritten. A corresponding message is displayed.

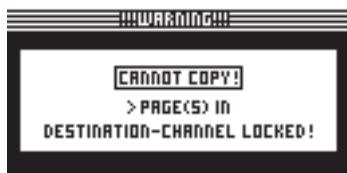

Fig. 4.18: Setup → Copy

4.2.4 PAGE LOCK

In this menu you can lock individual parameter pages, preventing them from being edited without first entering a password. This is useful for P.A. rental companies, for example, who want to make sure that certain “harmful” pages with necessary fixed settings cannot be accessed by the user.



Fig. 4.19: Setup → Page Lock

In the PAGE LOCK menu you can either lock single pages or all pages. In this case, you need a password to edit the pages. The parameter PAGE LOCK is set to OFF by default. As long as it is not ON, you can skip this page and move on to the next.



Fig. 4.20: Setup → Page Lock

To lock a parameter page you must activate the PAGE LOCK function (ON). The unit will prompt you to enter a password. Use the data wheel to enter a password with a maximum of 8 characters, and confirm your selection with OK.

- ◆ CAUTION: Please make a note of your password. It is impossible to unlock parameter pages without the correct password!



Fig. 4.21: Setup → Page Lock

Now, the parameter SELECT PAGES is displayed, enabling you to select all the pages to be locked. Use the IN/OUT/SUM/SETUP buttons to call up a menu, the data wheel to select the page of your choice and the OK button to activate the PAGE LOCK function.

The data wheel also allows you to scroll through a list of all pages, from which you can select the ones you wish to lock. **This is the only way to call up the ALL PAGES function that lets you lock all pages in one operation. To unlock all pages at once, select ALL PAGES and press CANCEL.** As before, the selected pages must be confirmed and locked with OK. Locked pages are displayed with a closed lock symbol. If a page is unlocked, the lock symbol is open. Use the CANCEL button to unlock a previously locked page.

- ◆ The OK and CANCEL functions cannot be selected in the display with the cursor. They can only be activated with the corresponding buttons on the front panel.

Use the CHECK function for an overview of all locked pages. The locked pages from the list now appearing can be selected with the data wheel. This function is located at the bottom right of the display and must be selected with the cursor.

When you call up a locked page, you will at first notice no difference. Only when you try to edit a parameter, will the display prompt you to enter your password. Entering the correct password and confirming it with OK will take you back to the page, now ready for editing.

To activate PAGE LOCK again, go to the PAGE LOCK page (4/6) and enter your password again. Now, all settings are available, i.e. you can activate or deactivate PAGE LOCK completely by selecting the line “PAGE LOCK: ON” with the cursor and setting this parameter to ON or OFF with the data wheel.

4.2.5 GLOBAL LOCK

This function allows you to lock all parameter pages if you want to make sure that nobody can edit your settings while you’re away during a break in a live performance, for example.



Fig. 4.22: Setup → Global Lock

On this SETUP page you can activate the GLOBAL LOCK function (ON), enter a password, then confirm with OK. Now, if you try to edit any parameter, the display will prompt you to enter your password. The process follows the same logic as the PAGE LOCK routine.



Fig. 4.23: Setup → Global Lock

◆ Activating PAGE LOCK and/or GLOBAL LOCK automatically locks all STORE and RECALL pages.

CAUTION: If you have locked individual pages with PAGE LOCK and deactivated the GLOBAL LOCK function with the correct password, you can not yet make any changes to the corresponding page. You must first unlock this page in the PAGE LOCK menu. When using the GLOBAL LOCK feature, we recommend that you unlock all pages in the PAGE LOCK menu (UNLOCK ALL).

4.2.6 MISCELLANEOUS



Fig. 4.24: Setup → Miscellaneous

On this page, the current version of your DCX2496 operating software is shown in the top right corner of the display (e.g. VERSION: 1.0). This is just a message and cannot be selected. Additionally, this menu provides five user settings. Firstly, you can adapt the **CONTRAST** of the display to ambient conditions. Secondly, you can assign a **DEVICE ID** to your DCX2496, allowing you to daisy-chain several units via the rear panel RS-485 network interface (LINK A and B). The first unit is connected to a PC either via one of the LINK interfaces (RS-485) or via the RS-232 interface.

The **PORT** parameter provides three different modes for the PC remote control:

1. PC (RS-232)



Fig. 4.25: Setup → Miscellaneous

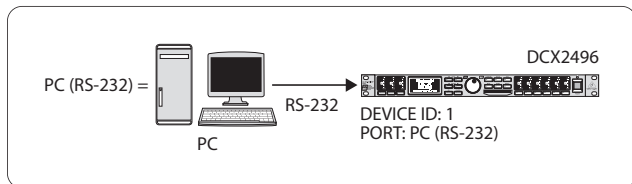

Fig. 4.26: PC (RS-232) mode

Use this setting if you want to connect only one DCX2496 to your computer via the RS-232 interface. It is impossible to daisy-chain several units in this mode.

2. LINK (RS-485)



Fig. 4.27: Setup → Miscellaneous

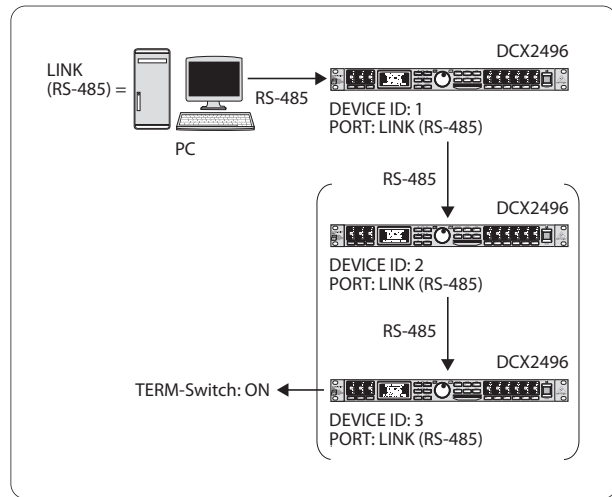

Fig. 4.28: LINK (RS-485) mode

Please use this mode when several ULTRADRIVE PROs are linked to each other via the network interfaces LINK A and B and the first unit in the chain is connected to a computer via the RS-485 interface. The last unit in the chain must have a termination (TERM switch on rear panel = ON). The RS-232 interface is not used in this configuration.

3. PC -> LINK



Fig. 4.29: Setup → Miscellaneous

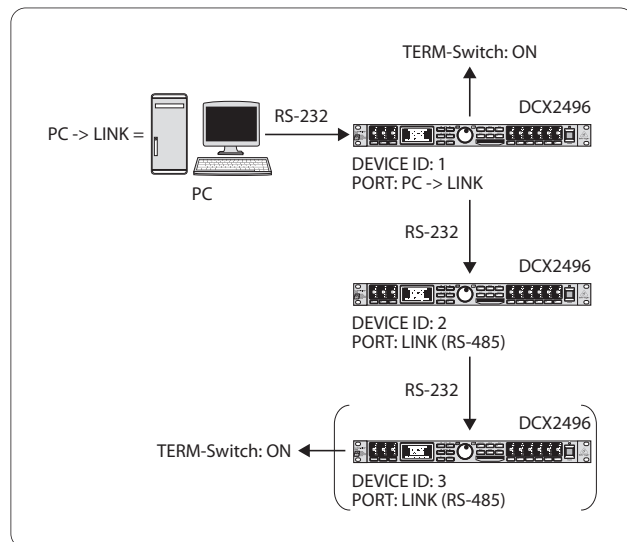

Fig. 4.30: PC -> LINK mode

Please use this mode on the first unit when several ULTRADRIVE PROs are linked to each other via LINK A and B, and the first unit in the chain is connected to a computer via the RS-232 interface. In this configuration, the last AND the first unit in the chain must have their TERM switch ON, since both are integrated into the system via only one LINK interface.

- ◆ **General rule: Whenever one device within a chain has been connected to the system via only one LINK interface, its TERM switch must be pressed (ON) to avoid data reflections and hence transmission errors. In PC (RS-232) mode this switch is not needed because the LINK interfaces are not used.**

The parameter **DELAY UNIT** determines the units of both measurement and temperature used for the delay settings in the corresponding menus. You can choose between m / mm / °C° and ft / in / F°. When you change from meters/millimeters to feet/inch, the temperature will be changed automatically from °Celsius to °Fahrenheit. These settings cannot be made independently of each other.

The **MUTE OUTS WHEN POWER ON** function is used to protect connected equipment such as power amps and loudspeakers. When it is on (YES), all outputs of the ULTRADRIVE PRO are muted during power-up. To restore the output configuration of your presets, you will have to activate the respective outputs individually or call up the preset again using RECALL (see chapter 4.7). Using RECALL to switch from one preset to another automatically mutes all outputs, **as soon as a preset has a different output configuration**. However, if the output configurations are the same, the muted outputs of the new preset will be loaded.

When MUTE OUTS WHEN POWER ON is disabled (NO), the last output configuration used will be recalled during power-up.

4.3 IN A/B/C menu

On these pages you can define the EQ, delay and similar values for the individual input signals, and hence optimize the overall sound.

4.3.1 GAIN

Press one of the buttons IN A, IN B or IN C to enter the INPUT menu of the corresponding input. On the first page, you can adjust the input gain for the signal (**GAIN**). The setting range is from -15 to +15 dB.

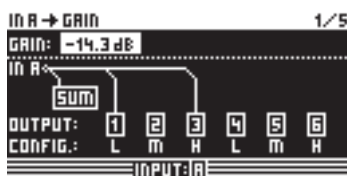

Fig. 4.31: In A → Gain

Below this parameter you can see a graphic representation of the current IN-OUT configuration (**OUTPUT CONFIG**). Additionally, the display shows whether or not the input is used for the SUM signal (see chapter 4.4). **This is just a message. You cannot edit anything here!** OUT configurations are shown on the SETUP page 1/6. The input source selection for SUM and for the various OUTs is determined on page 1 in the corresponding menus (SUM, OUT).

4.3.2 DELAY/NAME



Fig. 4.32: In A → Delay/Name

You can delay either the IN A, B or C signal to compensate for arrival time differences—resulting from offset stereo signals or so-called “delay lines” (“delay towers”). Activate the function with **DELAY (ON)** and select the delay time of your choice with **DISTANCE/TIME**. The values DISTANCE and TIME are linked to each other, i.e. both values are edited simultaneously when you turn the data wheel. **IN A (B/C) NAME** allows you to enter a name with a maximum of 8 characters for the input signal selected.

4.3.3 EQ



Fig. 4.33: In A → EQ

On this page you can process the sound of the input signals with the help of various equalizer settings.

The EQ parameter determines whether this function is generally ON or OFF. In the adjacent **NR** field you can select the number of EQs. There are various filters available, which can be used and edited. Their number depends on the current processor capacity, which is shown as a percentage next to the number of the filter. The free capacity of the processor is directly dependent upon the number and type of the filter selected (e.g. >FREE: 33%).

Use **TYPE** to define the filter type you wish to use. You can choose from low-pass (LP), high-pass (HP) and band-pass (BP) filters. Description:

The low-pass filter raises (positive gain) or lowers (negative gain) the level of the frequency band below the adjusted frequency. The high-pass filter raises (positive gain) or lowers (negative gain) the level of the frequency band above the adjusted frequency. Use TYPE to set a slope of 6 or 12 dB/oct. for the high-pass or low-pass filter, or to determine the quality (Q) of the band-pass filter.

The band-pass filter raises or lowers the level of the frequency range around the adjusted frequency. The quality parameter Q determines the width of the resulting bell-shaped filter curve.

The **FREQ** parameter controls the cutoff frequency, at which the filter starts working. In the case of the low-pass and high-pass filters, the cutoff frequency is the point, at which low and/or high frequencies are processed. The entire frequency spectrum ranges from 20 Hz to 20 kHz.

Use the **GAIN** parameter to define the degree of boost/cut applied to a specific frequency band. The setting range is from -15 to +15 dB.

- ◆ **When you set GAIN to 0 dB, the corresponding filter is inoperative! This means that you cannot select a new type. Only when this value is higher or lower than 0 dB, will the filter be activated, and you can select a new filter type. Please note that two or more filters are used for one frequency range when LINK is active. Consequently, the processor performance will decrease.**

With the **Q** parameter you can set both the quality of the band-pass filter and the amount of interaction with adjacent frequency ranges around the center frequency. The higher this value, the lesser the influence on neighboring frequencies. This function is available only for the band-pass filters; its range is adjustable from 0.1 to 10.

The number of filters available depend on the processing power (>FREE) available. Filters can be allocated to either the inputs or outputs in any proportion. The more filters are activated, the lower the processing power and vice versa.

4.3.4 DYNAMIC EQ (FILTER)

As the DYNAMIC EQ is a highly complex module, its parameters are allocated to two pages—the FILTER and the DYNAMICS parameters pages.

The DYNAMIC EQ influences a specific frequency range of the signal, depending on the volume level. It can either boost or cut this frequency range, depending on the gain setting made by the user. If the gain control is set to lower the respective frequency range in level, and if a preset THRESHOLD is exceeded, the EQ modifies the sound by reducing the gain of the frequency range. The amount of gain reduction applied is defined by the RATIO value. When the signal drops below threshold again, the frequency range is “smoothed out” again, i.e. the DYNAMIC EQ stops processing the signal.

When you define a certain boost with the GAIN control, the gain of the frequency range is raised depending on the volume level. When the level of the selected frequency range drops below a preset THRESHOLD, the range is boosted by a certain amount (RATIO). As soon as the threshold is exceeded again, the DYNAMIC EQ stops processing the signal.



Fig. 4.34: In A → Dynamic EQ (→ Filter)

The complete DYNAMIC EQ (FILTER) page corresponds to the EQ page in terms of operation and to the parameters in terms of number and type. Exception: Only one filter is selectable.

4.3.5 DYNAMIC EQ (DYNAMICS)

On this page you can edit both the threshold and the operating mode of the compressor and/or expander (volume-dependent sound processing).



Fig. 4.35: In A → Dynamic EQ (→ Dynamics)

The **THRESHOLD** parameter defines a threshold, activating the filter function once that threshold is exceeded. If the filter has been set to reduce the gain on the DYNAMIC EQ (FILTER) page (GAIN < 0), this frequency range will be cut, as soon as it exceeds the threshold.

However, if the filter has been set to raise the gain (GAIN > 0), the frequency range is boosted, as soon as its level drops below the threshold. The threshold setting range is from -60 to 0 dB.

Next, you can use the **RATIO** parameter to define the amount of gain boost/cut. RATIO adjusts the level balance between the input and output signals. Available settings range from 1.1 : 1 (minimum boost/cut) to ∞ : 1 (maximum boost/cut).

ATTACK defines how fast the DYNAMIC EQ reacts to signals exceeding or falling below THRESHOLD, and can be set from 1 to 200 milliseconds.

RELEASE controls the recovery time needed by the EQ to stop processing the signal, once it has exceeded or fallen below THRESHOLD (depends on the GAIN setting). Available RELEASE times are from 20 to 4,000 milliseconds.

	Settings
TYPE	BP
FREQ	1.00 kHz
GAIN	+15 dB > continuous line 0 dB > broken line -15 dB > dotted line
Q	0.1
THRESHOLD	-40 dB
RATIO	∞ : 1

Tab. 4.3: Band-pass settings with extreme values (results in fig. 4.36)

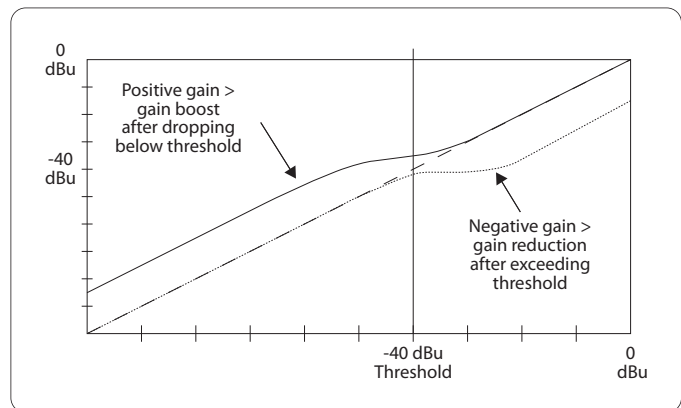

Fig. 4.36: Filter curves with gain above/below threshold

4.4 SUM menu

In addition to its inputs A-C, the ULTRADRIVE PRO DCX2496 provides an internal source signal that can be composed of these three input signals. This SUM signal can be edited at any time, much like any other input signal, so that you have a maximum of four separate source signals available.

4.4.1 INPUT/GAIN

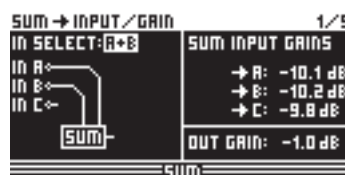

Fig. 4.37: Sum → Input/Gain

In this menu, the parameter **IN SELECT** allows you to define a combination of two inputs forming the SUM signal. Available options are: IN A + IN B, IN A + IN C and IN B + IN C. Of course, you can also use just one input signal as your SUM signal (IN A, IN B or IN C), by doubling one of the inputs. **It is impossible, however, to form a SUM signal composed of all input signals!**

If no additional source signal is required, set IN SELECT to OFF. The current SUM configuration is shown graphically below this parameter.

In the top left corner of the display you can use **SUM INPUT** Gains to adjust the input signal of the inputs A-C. The signal controlled here is taken directly from post-input converters—not post-EQ or post-Dynamics. Therefore, it is not necessary to re-adjust the input gain. The SUM INPUT GAINS setting range is from -15 to +15 dB.

With the **OUT GAIN** parameter you can control the internal output level of the sum signal. This signal is also taken pre-EQ, pre-Dynamics, etc. and is then routed to output channels 1-6. The gain setting also ranges from -15 to +15 dB. Thus, you can use one parameter to quickly adjust all inputs together in their adjusted balance at the same time.

The following SUM pages are 100% identical to the IN A/B/C pages 2/5 to 5/5 (see chapters 4.3.2 to 4.3.5)!

4.5 OUT 1-6 menu

Press one of the OUT 1-6 buttons to enter the OUTPUT menu of the respective output. Here, you can set the IN-OUT configuration, X-OVER POINT or, as with the input signals, the EQ and DYNAMIC EQ parameters.

4.5.1 GENERAL



Fig. 4.38: Out 5 → General

On the first page of this menu, the parameter **INPUT SOURCE** allows you to choose the input signal feeding the selected output. Available options are the inputs A-C and the additional SUM signal. If a STEREO-LINK configuration has been previously selected in the SETUP menu (see chapter 4.2.1. IN/OUT), input A will automatically be routed to the LEFT CHANNEL outputs, and input B to the RIGHT CHANNEL outputs. However, these preset configurations can be edited as desired.

The **OUT 1(-6) GAIN** parameter controls the volume level of the respective output channel (also pre-EQ, pre-DYNAMIC EQ, etc.). The setting range is from -15 to +15 dB. Just as the inputs, the output levels should be set properly to avoid distortion.

The third parameter, **OUT 1-6-NAME** can be used to assign specific names to the outputs. In contrast to the DCX2496 inputs, you cannot enter single characters here, but you may choose from a list of preset names (e.g. LEFT LOW-MID, RIGHT HI-MID, SUBWOOFER etc.). Depending on the output configuration (e.g. LMHLMH) and the output selected, the system assigns a default name. This name can be changed at any time by using the data wheel to select a different name from the list.

Output-configuration	OUT 1	OUT 2	OUT 3	OUT 4	OUT 5	OUT 6
LMHLMH	Left Low	Left Mid	Left Hi	Right Low	Right Mid	Right Hi
LLMMHH	Left Low	Right Low	Left Mid	Right Mid	Left Hi	Right Hi
LHLHLH	Left Low	Left Hi	Center Low	Center Hi	Right Low	Right Hi
MONO	Sub-woofer	Low	Low-Mid	Mid	Hi-Mid	Hi

Tab. 4.4: Default output names, depending on output configuration

4.5.2 X-OVER POINTS

On this page, you can define the cutoff frequencies and filter curves for the individual outputs, which are displayed graphically for one stereo side and over the entire frequency range. Use the OUT buttons 1-6 to select the output to be processed. A frame around the selected OUT number highlights your selection.

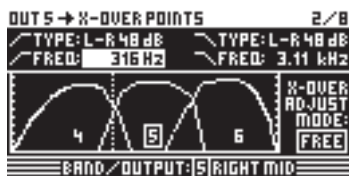

Fig. 4.39: Out 5 → X-Over Points

Use the **TYPE** parameter in the top left corner of the display to define the type of curve at the lower (left) slope. To define the upper (right) slope, use the **TYPE** parameter in the top right corner of the display. Both parameters are marked by a curve symbol.

You can choose from three different types of filters:

1. **Butterworth** (with a slope of either 6, 12, 18, 24 or 48 dB/oct)
 2. **Bessel** (with a slope of either 12 or 24 dB/oct.)
 3. **Linkwitz-Riley** (with a slope of either 12, 24 or 48 dB/oct.)
- ◆ With higher slopes, the number of filters goes down (see EQ page 3/6, display >FREE<). For each 12 dB increase in slope, you will lose 1-2 EQs.

The **FREQ** parameter in the top left corner of the display selects the lower (left) cutoff frequency for one output. With the same parameter on the right-hand side you can determine the upper (right) cutoff frequency. These parameters, too, are marked by a curve symbol.

The **X-OVER ADJUST MODE**, when set to "FREE", allows you to enter all TYPE and FREQ values, independent of one another. When set to "LINK", you can couple the X-Over filters of adjacent outputs. Though your entries are retained, they will be proportionally shifted with each parameter change. When you shift the upper cutoff frequency of OUT 1 in the LMHLMH configuration for test purposes, the lower cutoff frequency of OUT 2 will be shifted as well.

The following pages 3/8 to 5/8 (EQ, DYNAMIC EQ (FILTER) and DYNAMIC EQ (DYNAMICS)) are 100% identical to the IN pages 3/5 to 5/5!

4.5.3 LIMITER

To protect your power amplifiers and loudspeakers, the ULTRADRIVE PRO DCX2496 features a limiter for each of the six outputs. Use this device to suppress harmful level peaks.

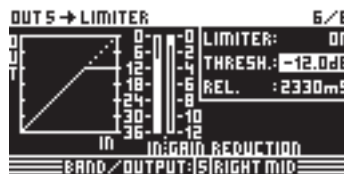

Fig. 4.40: Out 5 → Limiter

Use the **LIMITER** parameter to switch this function ON or OFF. The corresponding **THRESHOLD** parameter determines (similarly to the DYNAMIC EQ) the LIMITER threshold (-24 to 0 dB). **RELEASE** controls the recovery time that elapses between the point when the signal drops below THRESHOLD and the deactivation of the LIMITER function (20 to 4,000 ms).

4.5.4 POLARITY/PHASE

Any phase errors at the outputs (cancellation of specific frequency ranges) may be corrected here.

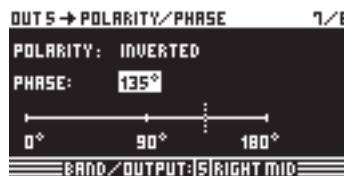

Fig. 4.41: Out 5 → Polarity/Phase

The **POLARITY** parameter determines whether the phase of an output signal is **INVERTED** or not (**NORMAL**)—just as if you had inverted the polarity of your speakers. Use the **PHASE** parameter to adjust the precise phase position **at the upper X-OVER frequency** of the currently selected output. This fine adjustment is necessary when two output signals are not perfectly displayed by 0° or 180° with regard to each other.

4.5.5 DELAY

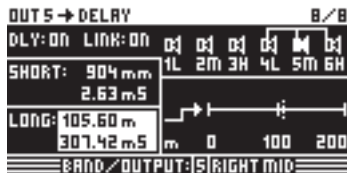

Fig. 4.42: Out 5 → Delay

The **DLY** parameter in the top left corner of the display switches the **DELAY** function ON or OFF. With the **LINK** function you can couple several output DELAYS, so that you only have to adjust one DELAY for a whole stack of speakers. **However, this applies to LONG DELAY values only.** SHORT DELAY values can be adjusted separately and independently of the LINK function, and can be linked to each other in the **SETUP** menu (page 1/6), using the parameter **OUT STEREO LINK**.

The parameters **SHORT** and **LONG** allow you to define the DELAY values of your choice. The setting range for the **SHORT** Delay is from 0 to 4,000 ms (= 0.00 to 11.64 ms) and the **LONG** Delay can be adjusted from 0.00 to 200.00 ms (= 0.00 to 582.24 ms).

With the **LINK** function activated, all **LONG DELAY** changes at one output are transferred to the corresponding output (L > M > H of one stereo side)—irrespective of the selected output configuration (e.g. LMHLMH).

◆ If the **LINK** function is activated for one output, it will be switched on for **ALL** other outputs as well.

When you have set all DELAY values for the outputs and then activated the **LINK** function for one of them, the **LONG DELAY** values are **NOT** transferred to the linked outputs. This happens only when you edit any parameters that change the values of the linked outputs proportionally. The current DELAY values are still not copied, but rather the linked output values follow the changes.

The output links are shown graphically, with the currently selected **OUT** channel displayed as an inverted loudspeaker, in the top right-hand corner of the display. Below are the DELAY times shown on a timeline.

4.6 MUTE menu



Fig. 4.43: Mute → Select

On this page, you can mute individual or all input/output channels. Use the parameters **MUTE ALL OUTS** and **MUTE ALL INS** to disable (OK) or de-mute (CANCEL) the inputs/outputs of the DCX2496 in one go. To mute or de-mute individual channels, please use the respective input/output buttons (e.g. **OUT 2**, **IN A**, **SUM**, etc.). The lower part of the display only shows the status of the channel and does not allow for any selection.

MUTE settings of any type can be made exclusively on this page. As soon as an input/output has been muted, the bottom red LED above the corresponding input/output button lights up.

Press **MUTE** again or select another menu to quit the **MUTE** menu. Pressing the **IN** or **OUT** buttons has no effect.

4.7 RECALL menu

The increasing popularity of portable computer systems such as notebooks and laptop computers has prompted consumers to ask for portable and exchangeable storage media to give them a certain amount of flexibility. In the late 80's a consortium of manufacturers developed a design, connection and software standard for memory cards called **PCMCIA** (**P**ersonal **C**omputer **M**emory **C**ard **I**nternational **A**ssociation). **PCMCIA** cards have also become the media of choice in audio engineering, allowing the user to store data externally via **PCMCIA** card slots. Today, the cards are usually referred to as **PC** cards.

Your **ULTRADRIVE PRO DCX2496** has a **PCMCIA** card slot on the front panel, allowing you to store your presets easily, without having to use the internal memory of the device. Use the **RECALL** menu to recall previously stored presets (see chapter 4.8)—from the card or from the internal memory.



Fig. 4.44: Recall → Internal/Card

In the upper display line, the parameter **CURRENT NR** indicates the current preset. If the preset has been edited but not yet stored, an arrow plus "EDITED" appears below this line. Now, if you try to load a new preset, the unit warns you that the current preset has not been saved yet. If you continue to load a new preset, all settings will be lost.



Fig. 4.45: Recall → Internal/Card

If you wish to store the current preset before loading a new one, cancel **RECALL** and change to the **STORE** menu (see chapter 4.8).

The parameter **RECALL NR** allows you to select the **BANK**, from which to load a preset (**INT** or **CARD**) and the **NUMBER** of the preset. Both values are shown in the large right-hand window. Use the data wheel to select a preset (1 - 60). Confirm your selection with **OK** to return to the previously selected menu (before entering **RECALL**).

◆ "Empty" presets (without a name) cannot be **RECALLED**.

4.8 STORE menu

Use this menu to store previously created presets in the internal memory or on a **PCMCIA** card.

◆ Only use "5 V ATA Flash Card" **PC** cards. Though the memory capacity of the storage medium can be selected freely, it is impossible to store more than 60 presets. If you need more memory capacity you can store your presets externally on a **PC** (data dump via **RS-232** or **LINK RS-485** interface).

4.8.1 INTERNAL/CARD



Fig. 4.46: Store → Internal/Card

In this menu, **STORE TO** selects the bank to which the preset is stored: INTERNAL or CARD. The window on the right-hand side lists the presets already stored in the internal memory or on a PCMCIA card. You can allocate a memory location to the preset, give it a **NAME** and overwrite an existing configuration or select an unused memory location. If you want to overwrite an existing preset, then confirm your command with OK. The display will prompt you to confirm once again. Press OK to confirm, or CANCEL to quit.



Fig. 4.47: Store → Internal/Card

If the preset to be overwritten was previously locked in the PRESET LOCK menu (see chapter 4.8.4), the process cannot be completed; a corresponding message is displayed.



Fig. 4.48: Store → Internal/Card

If you save to an unused preset location, the store command will be executed directly, i.e. without further prompts.

- ◆ Please note that you have to assign a name to each preset. Presets without a proper name cannot be saved.

AUTO-STORE

Your DCX2496 features an **AUTO-STORE** function. This means that all settings are saved automatically, once every few seconds, to a temporary, non-volatile memory. For example, if there is a power failure while you're editing, at least the last few edits (before the last auto-store operation) are available directly from the auto-store memory. This function cannot be disabled.

4.8.2 DELETE/FORMAT



Fig. 4.49: Store → Delete/Format

On the next menu page you can erase presets from the internal memory or an external memory card. Similar to the previous page, just use **DELETE** to select the BANK (CARD or INT), then, in the right-hand window, mark the preset to be deleted. When you press OK, the display prompts you to confirm your selection.



Fig. 4.50: Store → Delete/Format

Press OK to delete the preset. Locked presets cannot be deleted.



Fig. 4.51: Store → Delete/Format

Additionally, this menu page allows you to format a memory card. If CARD was selected in the DELETE menu, and the FORMAT CARD function is enabled, the lower display line changes from PUSH OK TO DELETE to PUSH OK TO FORMAT.



Fig. 4.52: Store → Delete/Format

When you confirm with OK, the preset warns you that formatting will erase all existing presets on the card.



Fig. 4.53: Store → Delete/Format

Confirm formatting with OK. Press CANCEL to quit.

- ◆ **ATTENTION: Formatting will also erase locked presets!**

4.8.3 COPY

On the third page of the STORE menu you can copy presets within one bank or from the internal memory (INT) to a PCMCIA CARD, and vice versa.



Fig. 4.54: Store → Copy

SOURCE selects the memory from which to copy (SOURCE BANK), while **DESTINATION** determines the DESTINATION BANK. Below, you can select the SOURCE PRESET and the DESTINATION PRESET. The display indicates both the number, name and status (LOCKED/UNLOCKED) of the preset.



Fig. 4.55: Store → Copy

- ◆ **Locked DESTINATION PRESETS cannot be overwritten. In this case, the display informs you that the process cannot be completed. Since SOURCE PRESETS will not get lost during the copying process, it does not matter whether they are locked or not.**

When all settings have been made and confirmed with OK, the DESTINATION PRESET is directly overwritten and the display indicates the name of the new preset. Locked SOURCE PRESETS are stored as unlocked presets. To lock them, go to the next page of the STORE menu (PRESET-LOCK). You can also unlock locked DESTINATION PRESETS there.



Fig. 4.56: Store → Copy

Additionally, you can copy all presets in one operation, by selecting ALL PRESETS in both SOURCE and DESTINATION PRESETS. Prior to that, all presets in the destination memory must be unlocked. When you confirm with OK, the displays warns you that all DESTINATION PRESETS will be overwritten.



Fig. 4.57: Store → Copy

Press OK to complete the process, or CANCEL to quit.

- ◆ **It is impossible to copy a bank to the same memory location (e.g. ALL INTERNAL PRESETS to ALL INTERNAL PRESETS).**

4.8.4 PRESET-LOCK



Fig. 4.58: Store → Preset-Lock

The last page of the STORE menu allows you to LOCK or UNLOCK your presets. **SELECT** selects the corresponding bank (INT or CARD), the right-hand window displays the preset. Use ALL PRESETS to select all presets. Press OK to lock the preset, or CANCEL to unlock it.

Here, you can unlock a DESTINATION PRESET you wish to overwrite, or lock recently copied presets.

5. Audio Connections

The BEHRINGER ULTRADRIVE PRO DCX2496 has standard electronically balanced inputs and outputs. The circuit design has an automatic hum suppression with balanced signals and is able to operate, without problem, even at highest levels. Externally-induced mains hum etc. is thus efficiently suppressed. The servo-function, also automatic, recognizes the connection of unbalanced pin assignments and changes the nominal level internally so that there is no difference in level between the input and output signals (6 dB correction).

- ◆ **Please ensure that only qualified persons install and operate the device. During installation and operation the user must have sufficient contact to earth. Electrostatic discharges might affect the operation of the unit.**

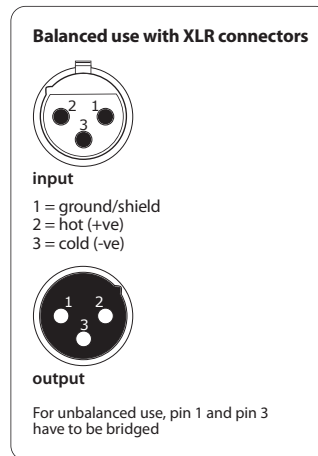

Fig. 5.1: XLR connections

6. Applications

On the following pages we present the most useful applications for your ULTRADRIVE PRO, using a few practical examples. For each example there is an appropriate preset available, which you can use as a starting point for your own set-ups.

Please note that these presets provide only basic outline settings that must be adapted to meet your specific requirements in terms of loudspeaker, amplifier and room acoustics!

The application examples are arranged in three groups:

1. **Classic setups (chapters 6.1 – 6.6)**
2. **Special applications: zoning / delay lines / surround (chapters 6.7 – 6.9)**
3. **Large-scale applications requiring two DCX (chapters 6.10 – 6.12)**

6.1 Stereo tri-amp operation

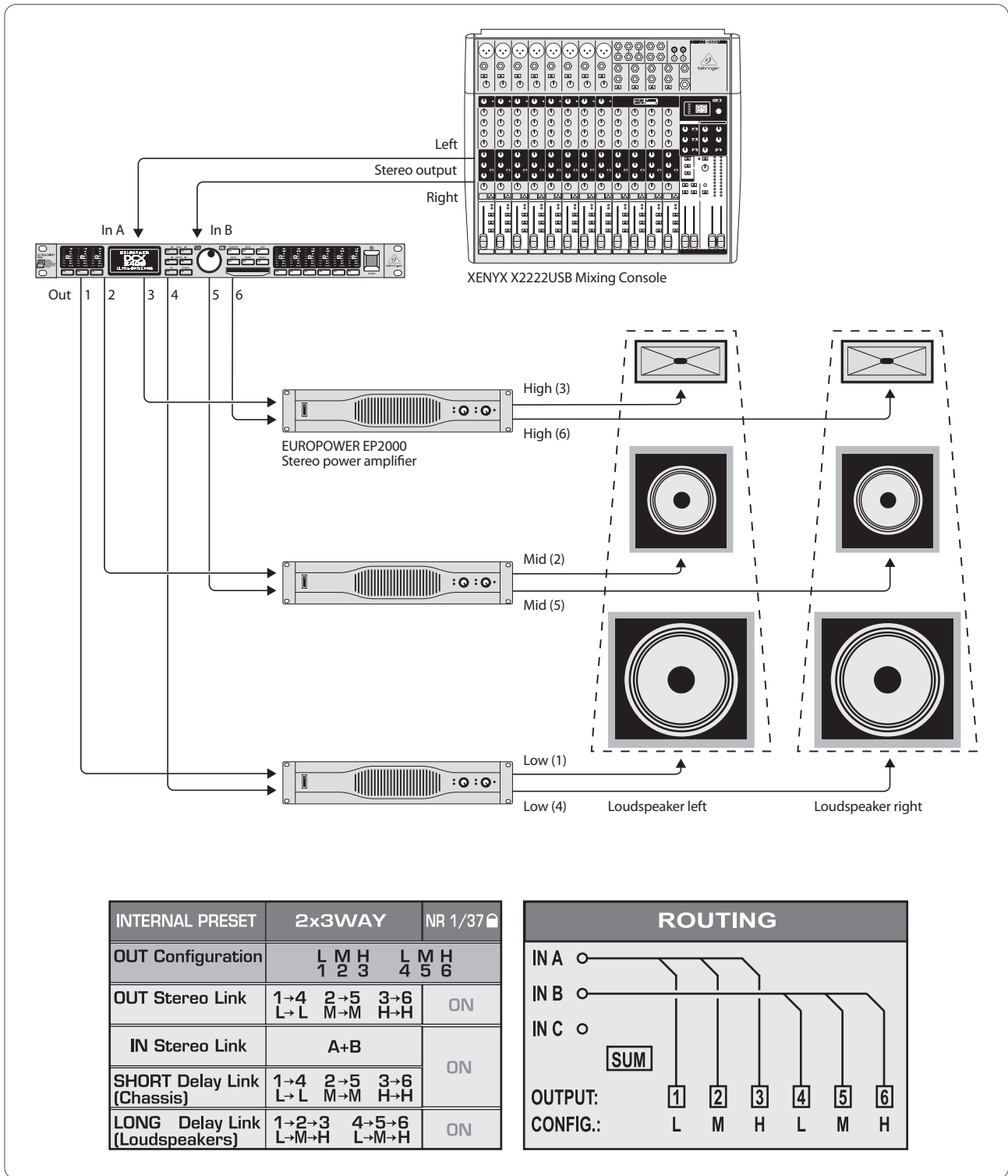

Fig. 6.1: Stereo 3-way operation

Stereo Tri-Amp operation is one of the most popular applications. The stereo input signals (In A+B) are split up into three frequency bands per stereo side and then reproduced using the 6 outputs. This ensures the best possible use of your 3-way sound reinforcement system, since the individual drivers reproduce only those frequency ranges for which they are ideally suited. Intermodulation distortion is thus effectively minimized.

6.2 Stereo bi-amp operation plus mono subwoofer

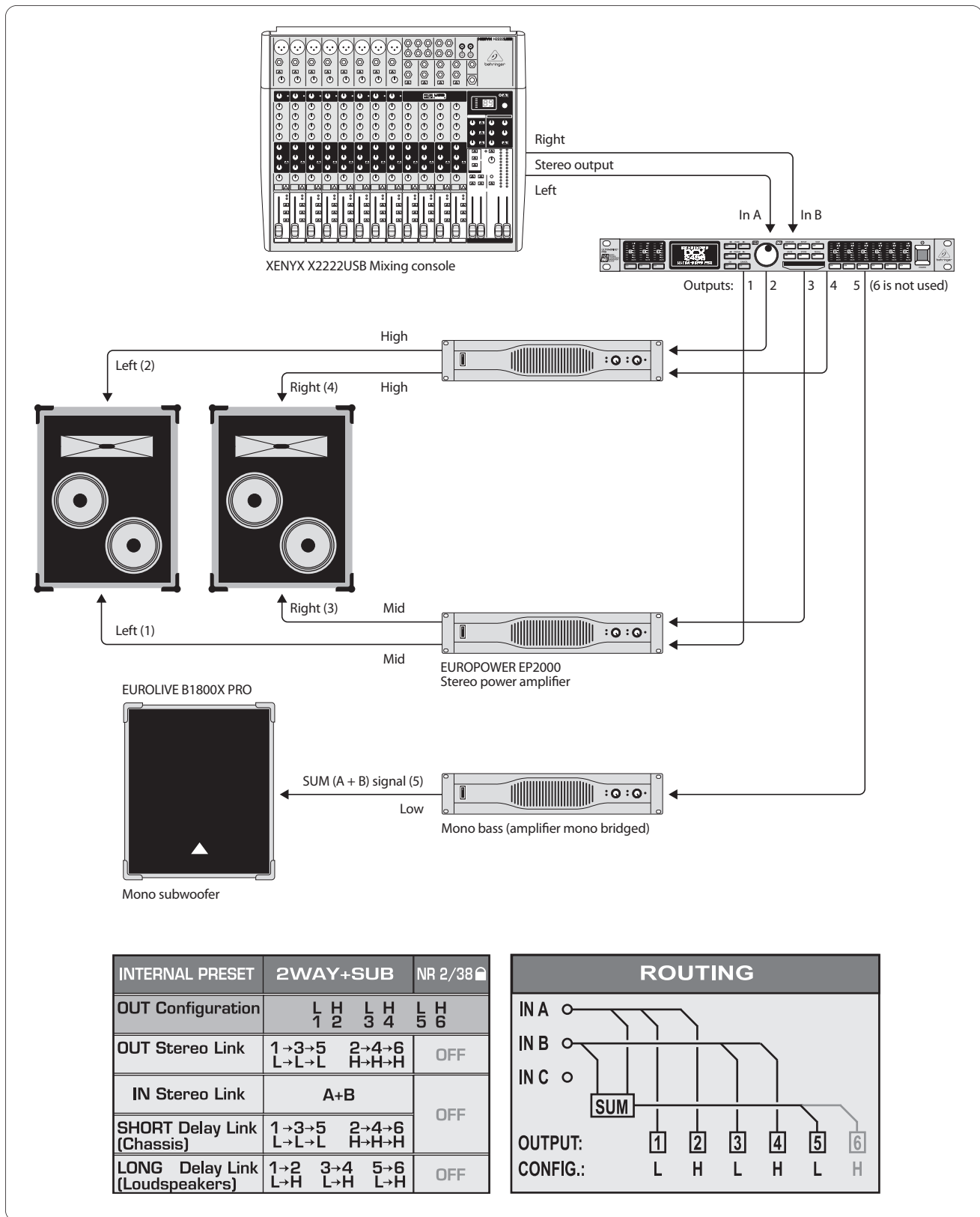

Fig. 6.2: Stereo 2-way operation plus subwoofer

Each driver (speaker diaphragm) of the two 2-way speaker cabinets is controlled separately to ensure optimum reproduction of treble and mid-range frequencies. The bass is reproduced by a mono subwoofer, which is driven by a power amp in mono-bridged mode. The sub-woofer receives its signal from the DCX's "SUM" input, which is limited to bass frequencies and is the sum of mix signals In A+B. The unused input C and output 6 could be used for a mono delay line, for example.

EN 6.3 3x bi-amp operation (LCR/Triple Bi-Amping)

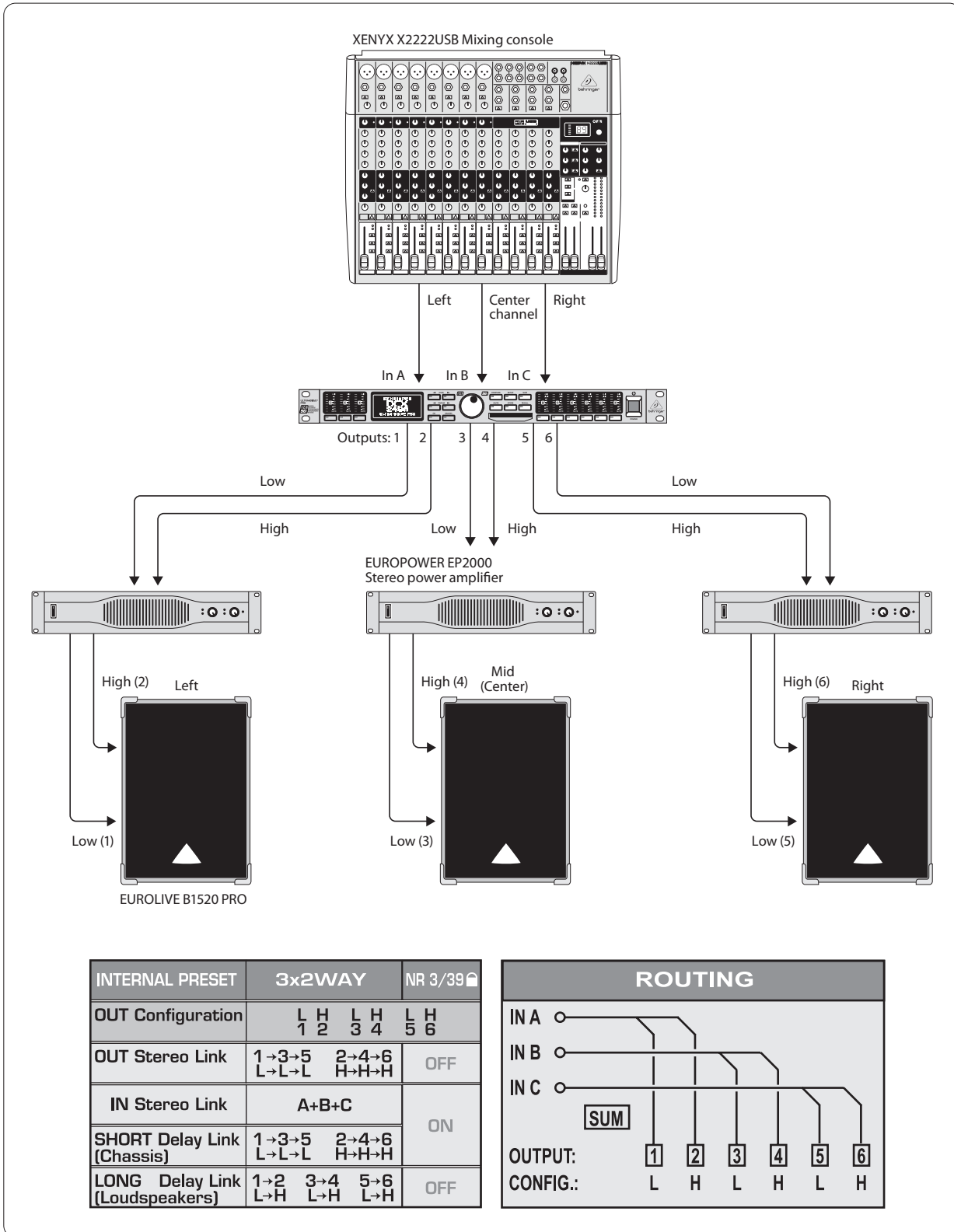

Fig 6.3: 3x2-way operation [LCR/Triple Bi-Amping]

Three 2-way speakers driven from three inputs. Such a setup is used for stage monitors or in cinemas, where, in most cases, the two stereo cabinets (completely to the left and right) are used to play back music and effects, while the center cabinet reproduces voices. Hence the name L-C-R, which stands for "Left-Center-Right".

6.4 Stereo operation plus mono subwoofer

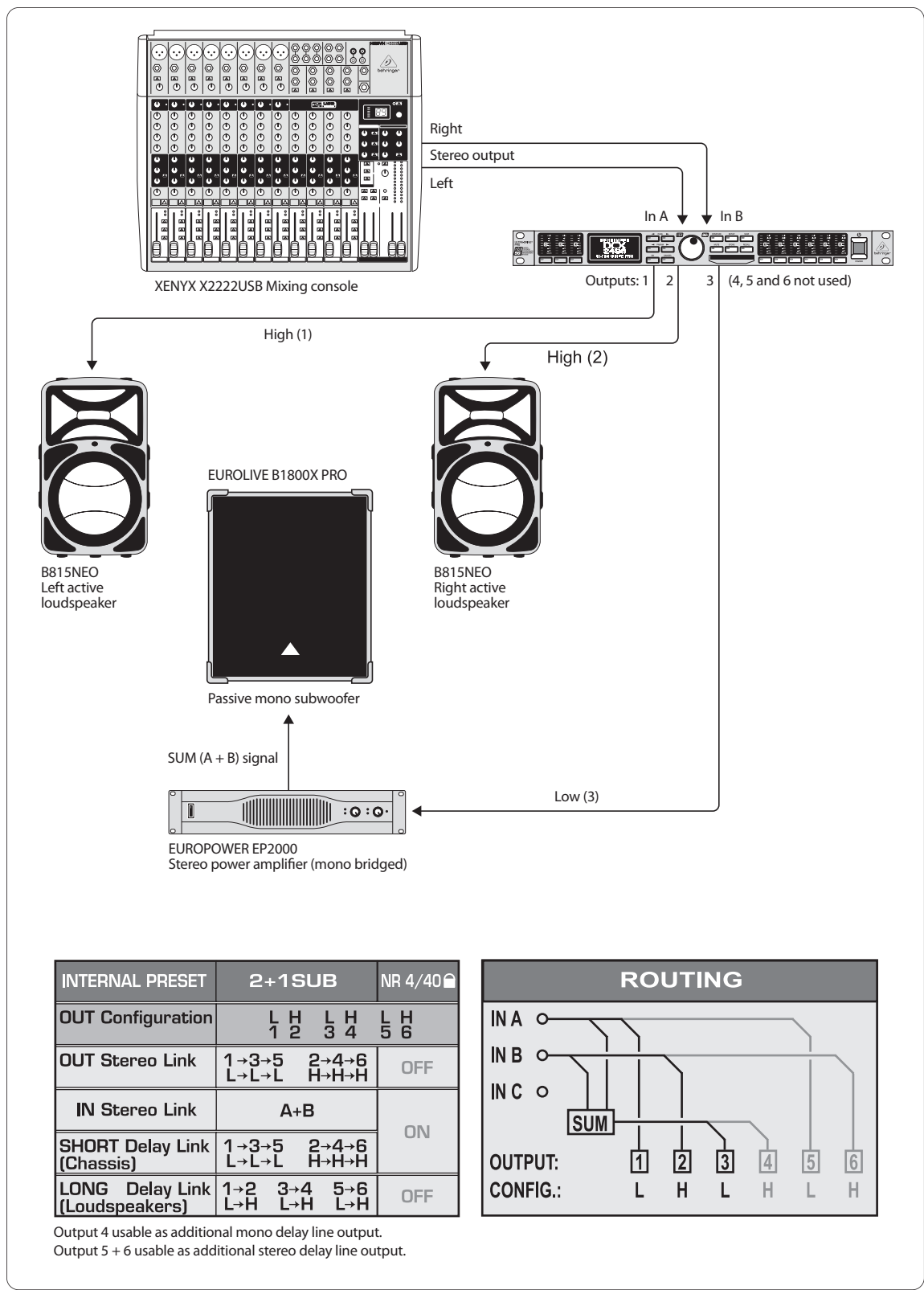

Fig. 6.4: Stereo operation plus mono subwoofer

A full-range stereo signal is sent to two active speaker cabinets for stereo reproduction. There is no need for a dedicated frequency separation because the crossover and amplifier in the active speaker are perfectly adapted to each other. However, to achieve more power in the bass, low frequencies are cut off in the active cabinets and routed to a subwoofer. The power amp is set to mono-bridged mode and the SUM signal derived from In A+B is sent to the subwoofer. Outputs 4 to 6 can be used as mono or stereo delay lines.

6.5 Stereo operation plus 2 subwoofers

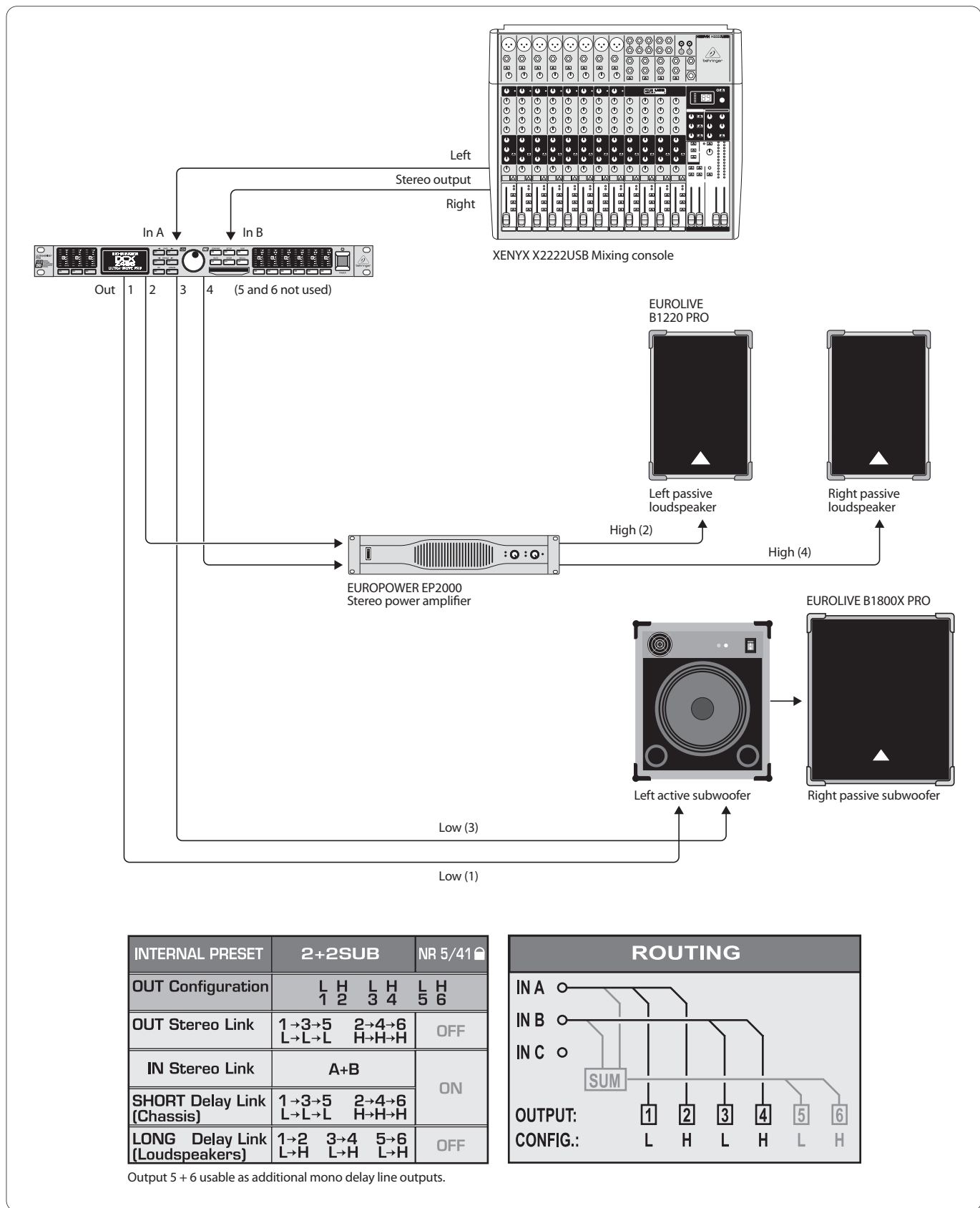

Fig. 6.5: Stereo operation plus 2 woofer cabinets

Only two frequency ranges (Low and High) are used on each stereo side. The two passive speaker cabinets for the higher frequencies are limited towards the bass end and are fine-tuned in their sound with the DCX's internal equalizer. The stereo bass signal is first sent to the active woofer, which also provides the passive woofer cabinet with sufficient power for the right-hand low-frequency channel. The unused outputs 5 and 6 can be used as mono delay lines.

6.6 Stereo bi-amp operation plus subwoofer and additional monitor

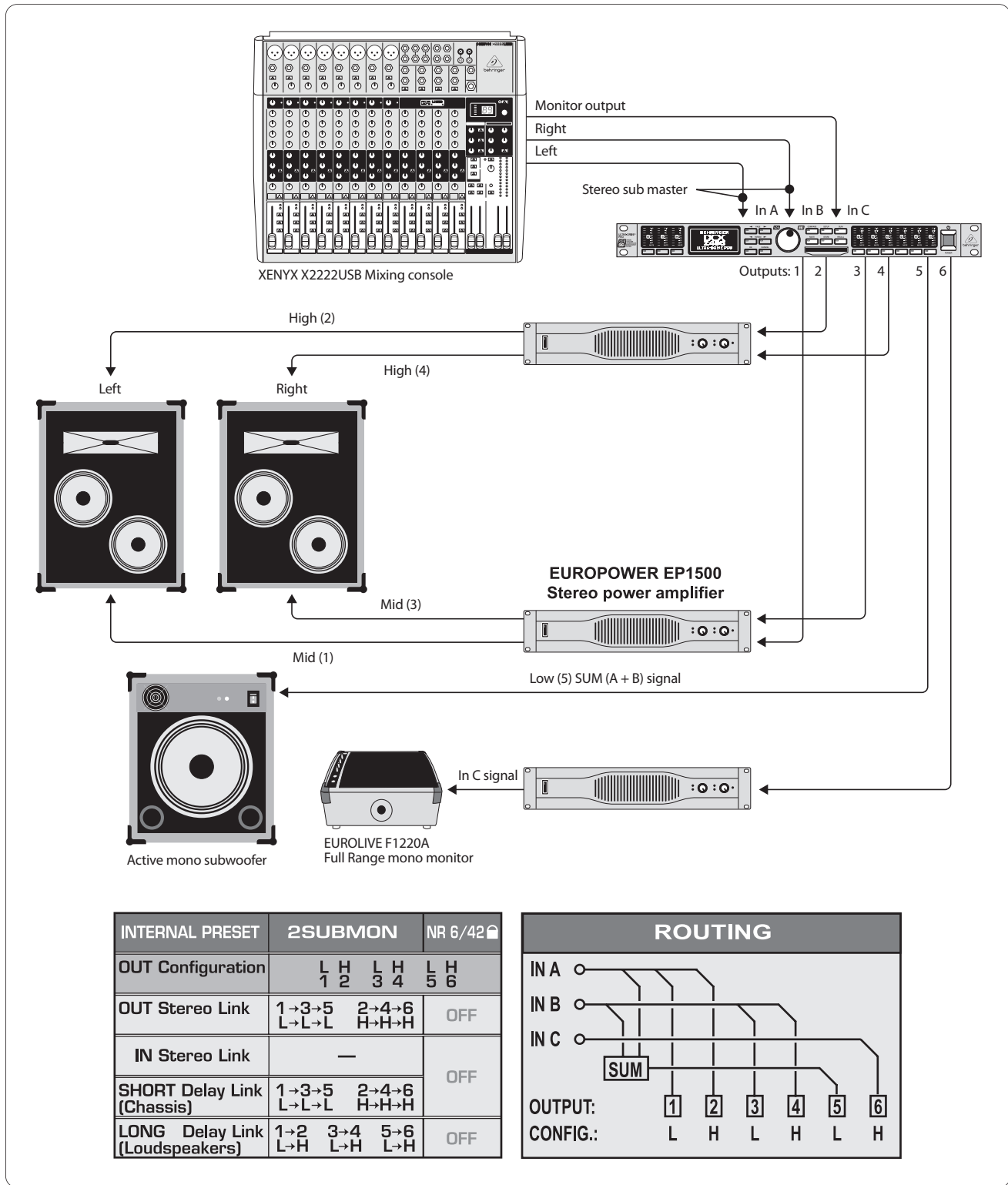

Fig. 6.6: Stereo 2-way operation plus subwoofer and additional monitor

Inputs A+B carry the stereo signal optimized for the two 2-way speakers. The woofer signal is derived from the sum signal of A+B, limited in its frequency range and routed to the active sub-woofer. A separate signal from the mixing console (aux/subgroup) for a separate speaker can be processed via In C. In our example, this is a full-range stage monitor with its own amplifier able to playback a dedicated monitor mix for the singer, drummer or other performers.

6.7 Mono 6-zone distribution mode

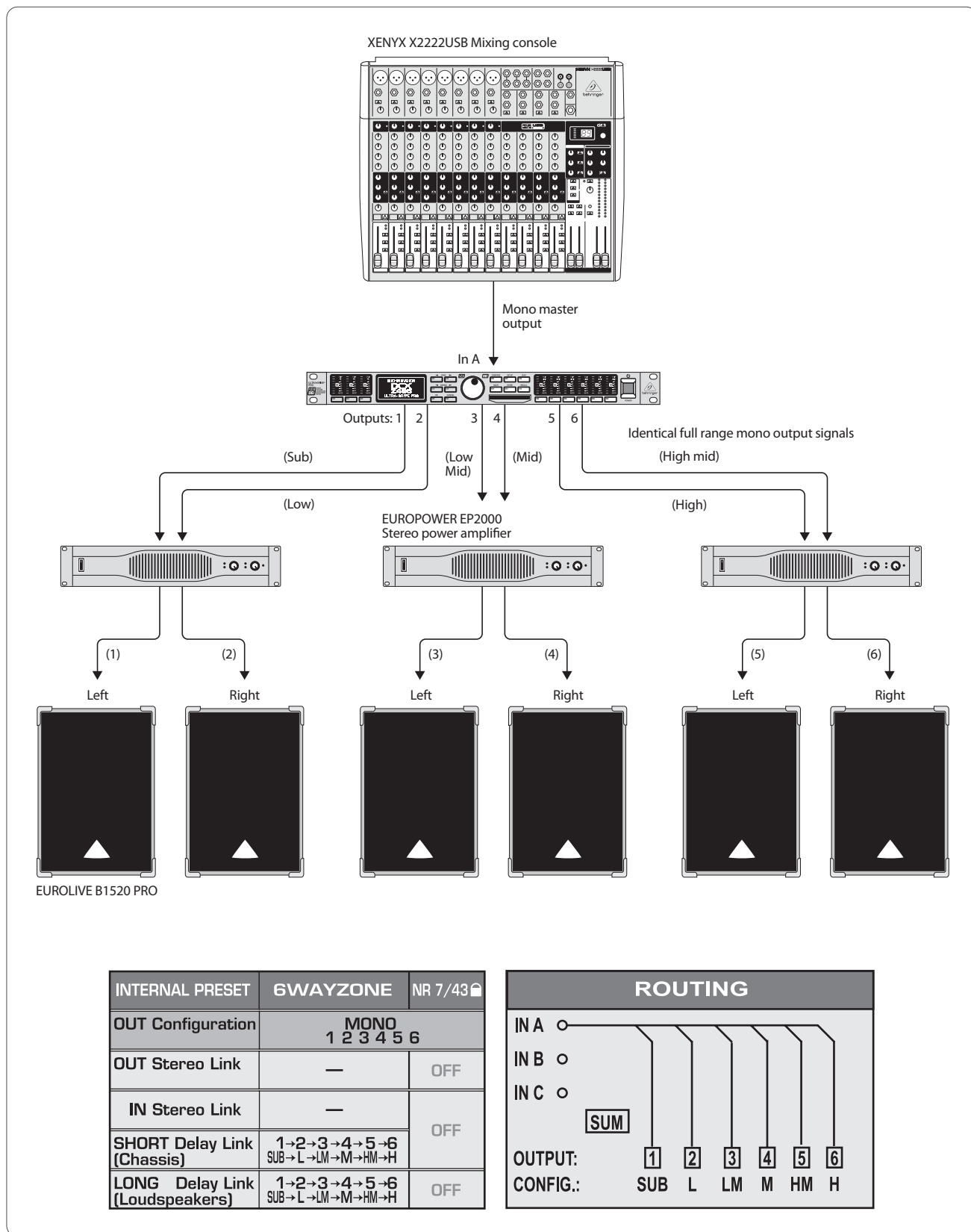

Fig. 6.7: Mono 6-way “Zoning” (signal distribution mode)

In this special-purpose application, the ULTRADRIVE PRO is not used as a frequency crossover but rather as a signal distributor, for dedicated EQing plus individual delays and separate volume settings for each output. The monophonic mix signal is split up and sent to six equal outputs. It can be used for a variety of applications requiring the transmission of music or speech over large distances or to several rooms or rooms consisting of several compartments. Examples are large discotheques, multi-room clubs/pubs/bars, shopping malls, restaurants, hotels, lobbies, trade show and conference halls, railway stations, churches/cathedrals and even at home where you can use the DXC2496 to play back music in every room.

6.8 Stereo 3-zone delay line

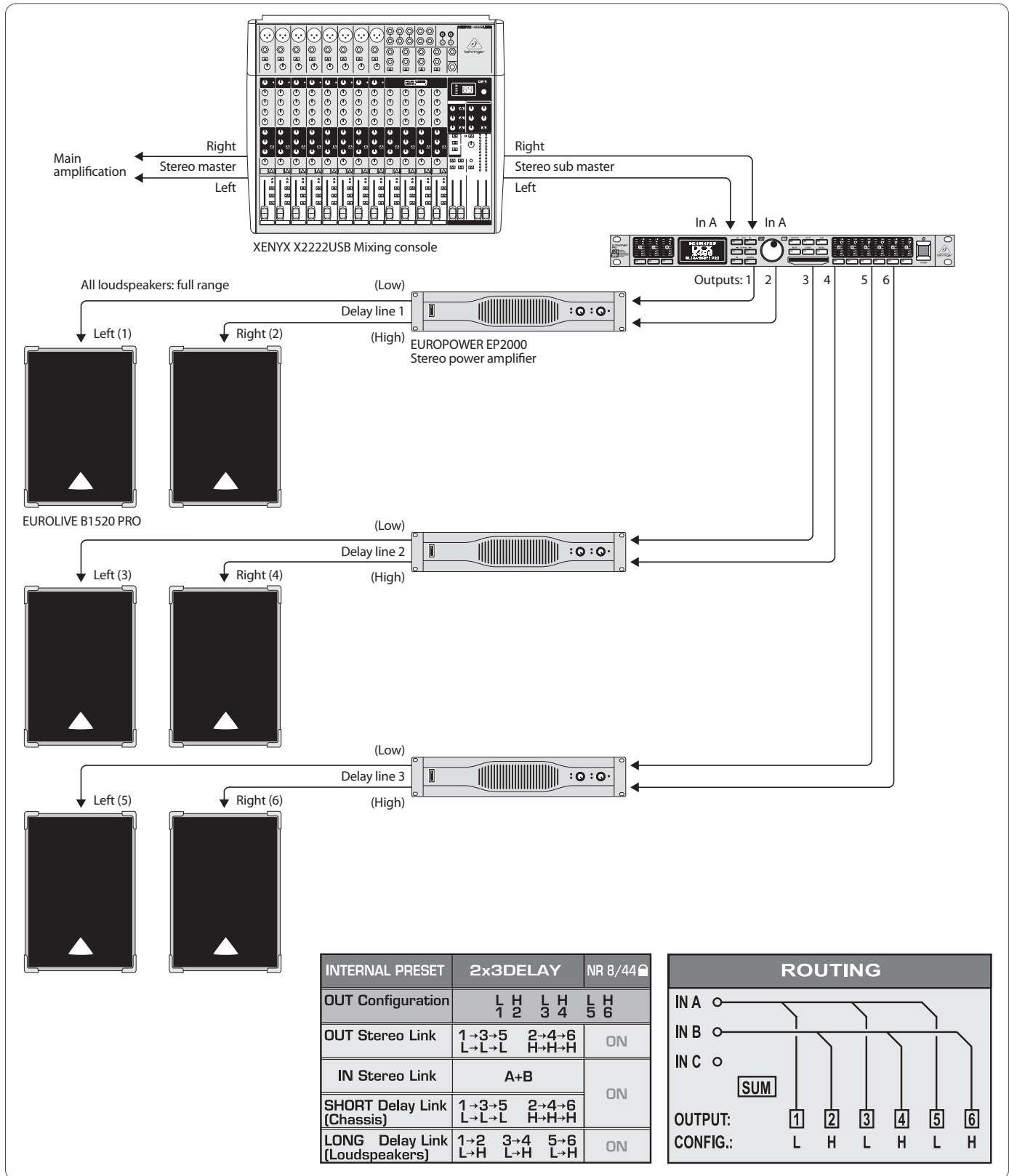

Fig. 6.8: Triple stereo delay line

In this application, the ULTRADRIVE PRO is not used as a crossover network. Instead, it produces stereo delay lines, i.e. stereo speaker cabinets delayed in time with regard to each other. All pairs of cabinets are supplied with the same full-range stereo input signal A+B. Then, these pairs can be placed at regular distances away from the stage, as is often the case at big open-air concerts. The farther away the original signal (usually the music played on stage) is, the more audible the delay between speaker signal (close to the listener) and original signal (far away) becomes. The DCX2496 allows you to make up for the resulting echoes by adding specific delay times to the speaker signals. This allows the audience to feel as if they were “part of it” even though they may be far away from the stage—and this without any annoying echoes.

6.9 3.0 Channel surround

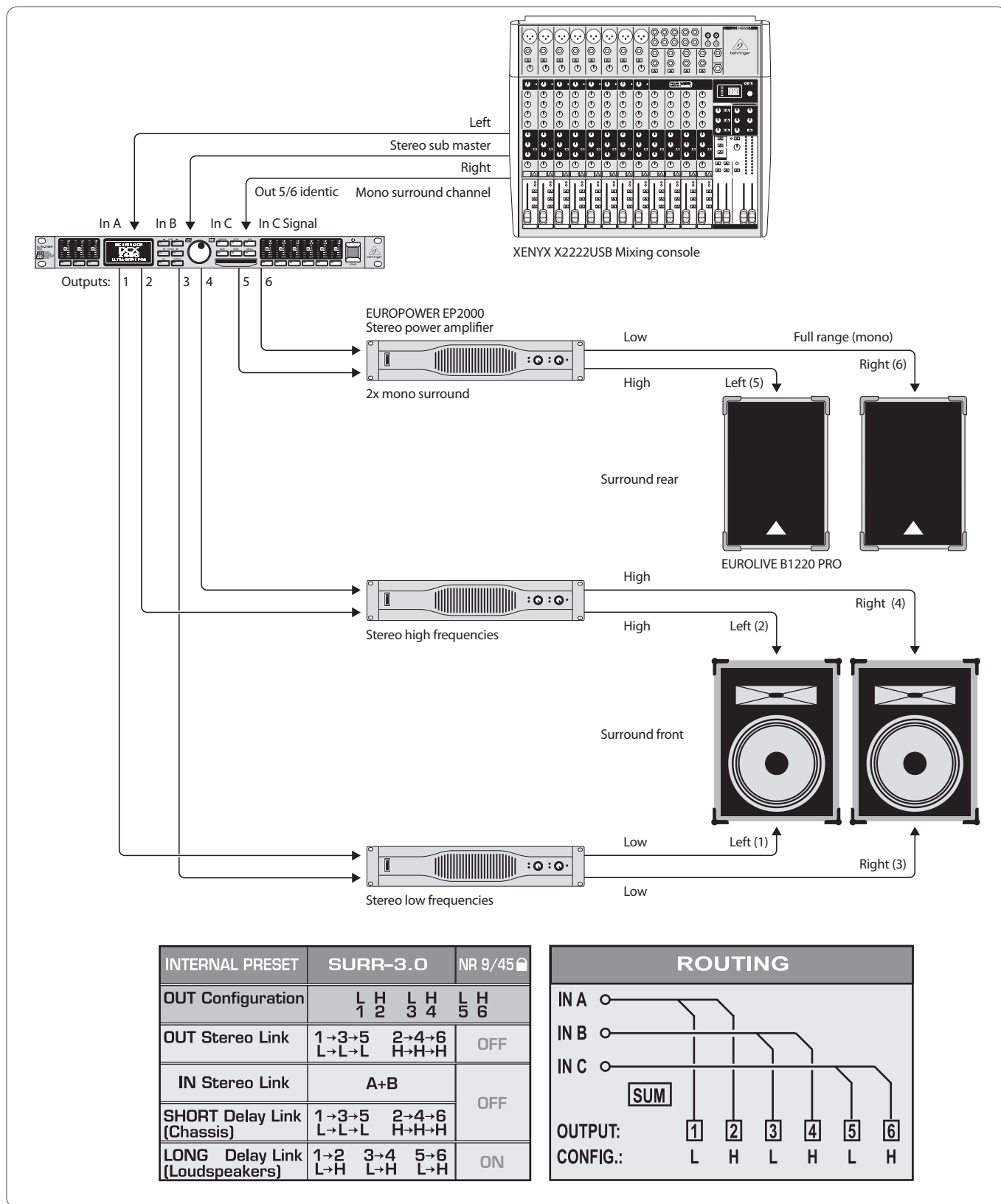

Fig. 6.9: Surround 3.0

With this 3-channel configuration your audience experiences a live surround sound that comes close to the popular “Dolby Surround” sound format. The 2-way front speakers carry the main stereo signal from inputs A+B. A separate mono surround signal is supplied via In C, which is reproduced by two rear (or side) full-range speakers. The surround signal can be a delayed signal derived from the stereo sum signal, it can be processed with reverb or any other effect, or it can even provide a separate sound. Using this configuration, your surround music performances, slide shows, silent-movies or video shows will be a real experience—the sound of ocean waves lapping onto the shore or space ships flying through outer space—all embedded into “atmo” sounds floating around the room.

6.10 Stereo 4-way bridged system plus 2 monitors

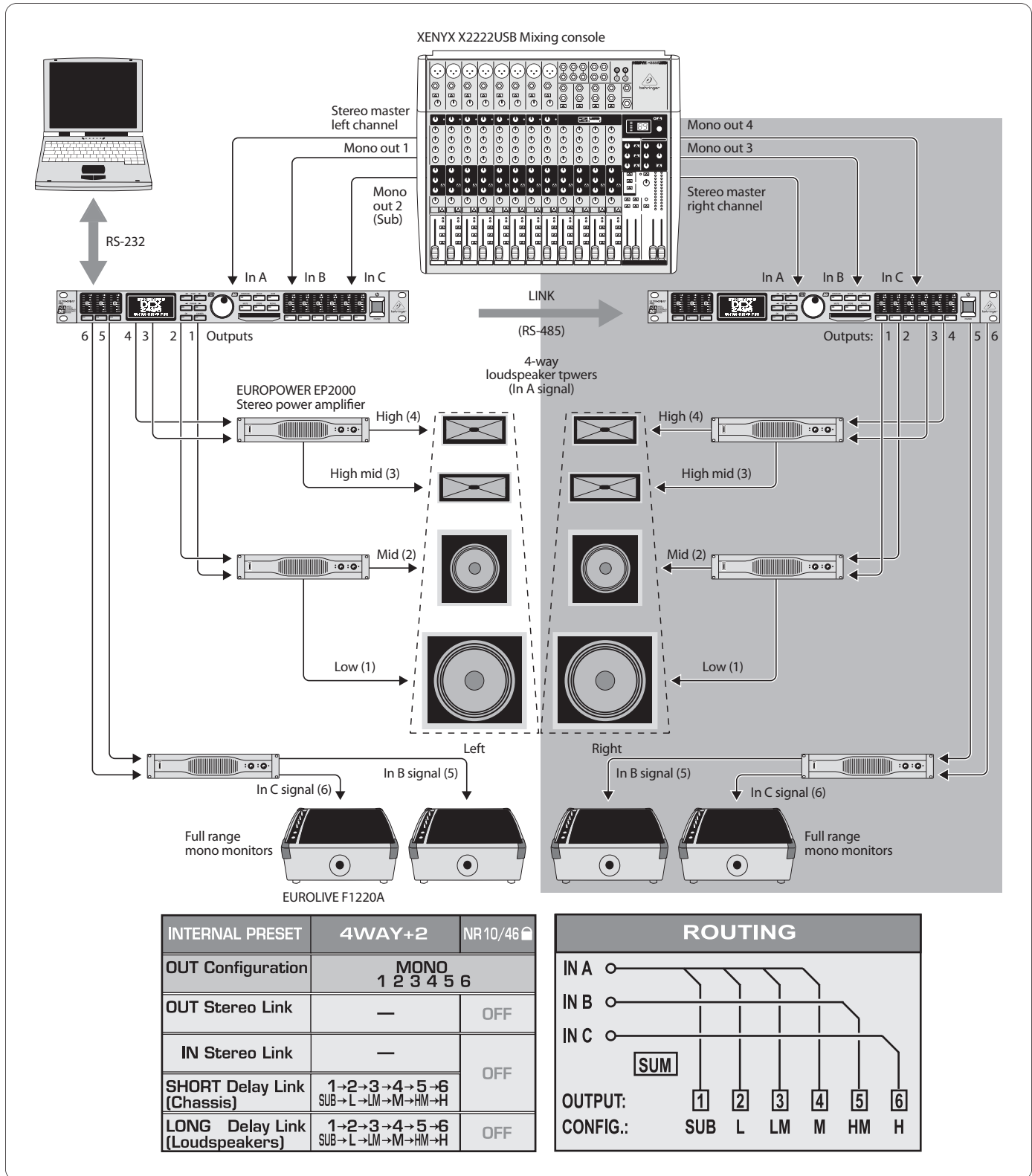

Fig. 6.10: 4-way mono-bridged operation plus 2 monitors (per stereo side)

This application uses one ULTRADRIVE PRO for each stereo side. When both units are coupled to each other via the LINK jacks, and one of them is additionally connected to a notebook/PC, you can use the computer to remotely control both devices with our free CrossOverRemote Software.

In this example, each DCX2496 is supplied with one side of the main stereo signal (In A). Two additional mono signals are routed from the console to inputs B and C. Two power amps each are used for the 4-way paths of each P.A. stack, while the third power amp drives two full-range stage monitors. This allows for building a stereo 4-way system that gives the musicians four on-stage monitors that can be “accessed” individually.

EN 6.11 5-way mono operation plus 1 additional mono signal

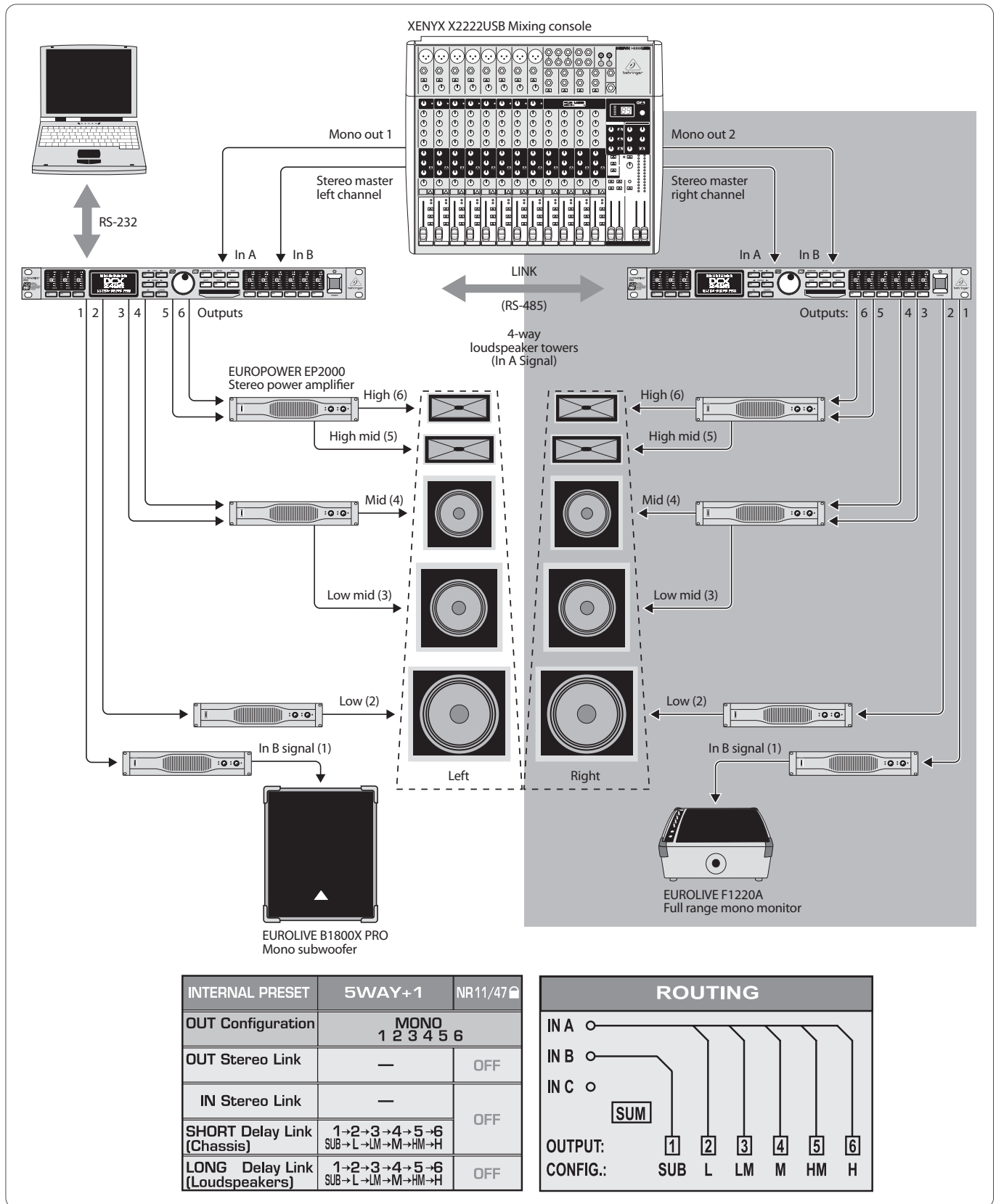

Fig. 6.11: 5-way mono operation plus 1 additional mono signal (per stereo side)

Again, two ULTRADRIVE PROs can be remotely controlled from a notebook/PC by using our free CrossOverRemote Software.

This set-up is similar to the one described in chapter 6.10. Here, however, even five frequency-optimized ways per stereo side are transmitted. The subwoofer has a separate mono-bridged power amp, just like the sixth channel, which can be used independently and is controlled from the separate B input. In our example, one of these mono channels is used for an individual subwoofer, while the the mono channel of the second ULTRADRIVE PRO drives a full-range stage monitor.

6.12 5.1 Surround operation

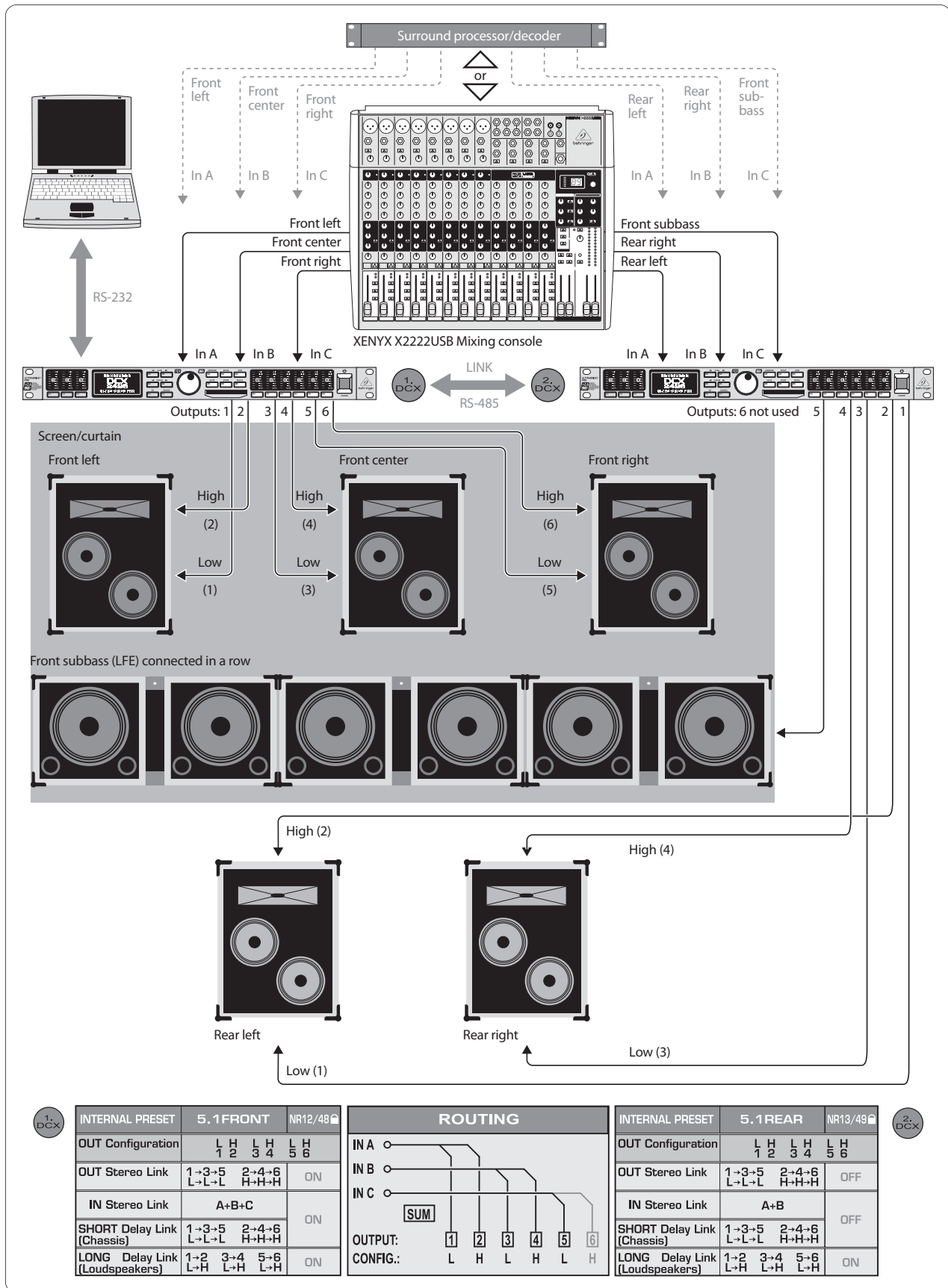

Fig. 6.12: Surround 5.1

(To be continued on next page...)

With two DCX2496 units you can even realize today's most popular surround format: 5.1. In addition to the speaker cabinets and power amps (or active speakers as in the simplified illustration shown here), all you need is a surround decoder to play back pre-produced 5.1 material such as DVDs, or a mixing console with six outputs (e.g. stereo out plus four subgroups). In the latter case, you can create highly sophisticated surround mixes even without a special surround sound decoder.

The preset "5.1 FRONT" has been optimized for the L-C-R front speakers with 2 speaker ways each (see also chapter 5.3). The three signals required "Front-Left, Front-Center, Front-Right" are routed via the three inputs (A, B, C) to the first DCX2496.

On the second DCX2496, the preset "5.1 REAR" should be used as a starting point. It supplies the two rear surround speakers (also 2-way systems) plus the monophonic sub-bass channel ("LFE" = "Low Frequency Enhanced") with the input signals "Rear-Left, Rear-Right and Sub-bass", using connectors In A, B, C. The sixth output of the second ULTRADRIVE PRO is not used in this application, but is left available for additional effects or as a mono delay line.

7. Specifications

Analog Inputs (A, B, C)

Type	electronically balanced
Connector	XLR
Max. input level	+22 dBu
Input impedance	approx. 20 k Ω at 1 kHz
Crosstalk	-72 dB @ 0 dBu In

Digital Input (A)

Connector	XLR
Format	S/PDIF or AES/EBU
Input level	0.3 to 10 Vpp
Input impedance	approx. 110 Ω
Sampling frequency	32 to 96 kHz
Special feature	Sample Rate Converter

Microphone Input (C)

Type	electronically balanced
Connector	XLR
Max. input level	-23 dBu
Input impedance	approx. 470 Ω at 1 kHz
Phantom supply	+15 V

Analog Outputs (1, 2, 3, 4, 5, 6)

Type	electronically balanced
Connector	XLR
Max. output level	+22 dBu
Output impedance	approx. 160 Ω at 1 kHz
Crosstalk	-100 dB @ 10 dBu In

System Data

Sampling frequency	96 kHz
Signal delay	< 1 ms Analog input to analog output
Frequency response	10 Hz to 35 kHz (-1 dB) typ.
Dynamic range	109 dB (analog input \rightleftharpoons analog output)
Input noise	-90 dBu (@ +22 dBu \rightleftharpoons 112 dB)
Output noise	-90 dBu (@ +22 dBu \rightleftharpoons 112 dB)
THD+N Ratio	0,007% @ 0 dBu In, Gain 1 0,004% @ 10 dBu In, Gain 1

Converters**A/D Converter**

Resolution	24-Bit Delta-Sigma AKM
Oversampling	64x
Dynamic range	112 dB typ.

D/A Converter

Resolution	24-Bit Delta-Sigma AKM
Oversampling	64x
Dynamic range	112 dB typ.

Serial Interface**RS-232**

Type	9-pin sub-D connector
Transmission type	115200 bauds, 8 data bits, 1 stop bit, no parity

RS-485 (2x)

Type	RJ-45 connector
Transmission type	115200 bauds, 8 data bits, 1 stop bit, no parity

Power Supply**Mains Voltage**

USA/Canada	120 V~, 60 Hz
Europe/U.K./Australia	230 V~, 50 Hz
Japan	100 V~, 50 - 60 Hz
General export model	100 - 240 V~, 50 - 60 Hz
Power consumption	approx. 12 W
Fuse	100 to 240 V~: T 1 A H
Mains connector	Standard IEC receptacle
DIMENSIONS (H x W x D)	1 ¾ x 19 x 8 ½" 44.5 x 482.6 x 217 mm
WEIGHT	approx. 3 kg
SHIPPING WEIGHT	approx. 4.2 kg

BEHRINGER makes every effort to ensure the highest standard of quality. Necessary modifications are carried out without notice. Thus, the specifications and design of the device may differ from the information given in this manual.

8. Block Diagram

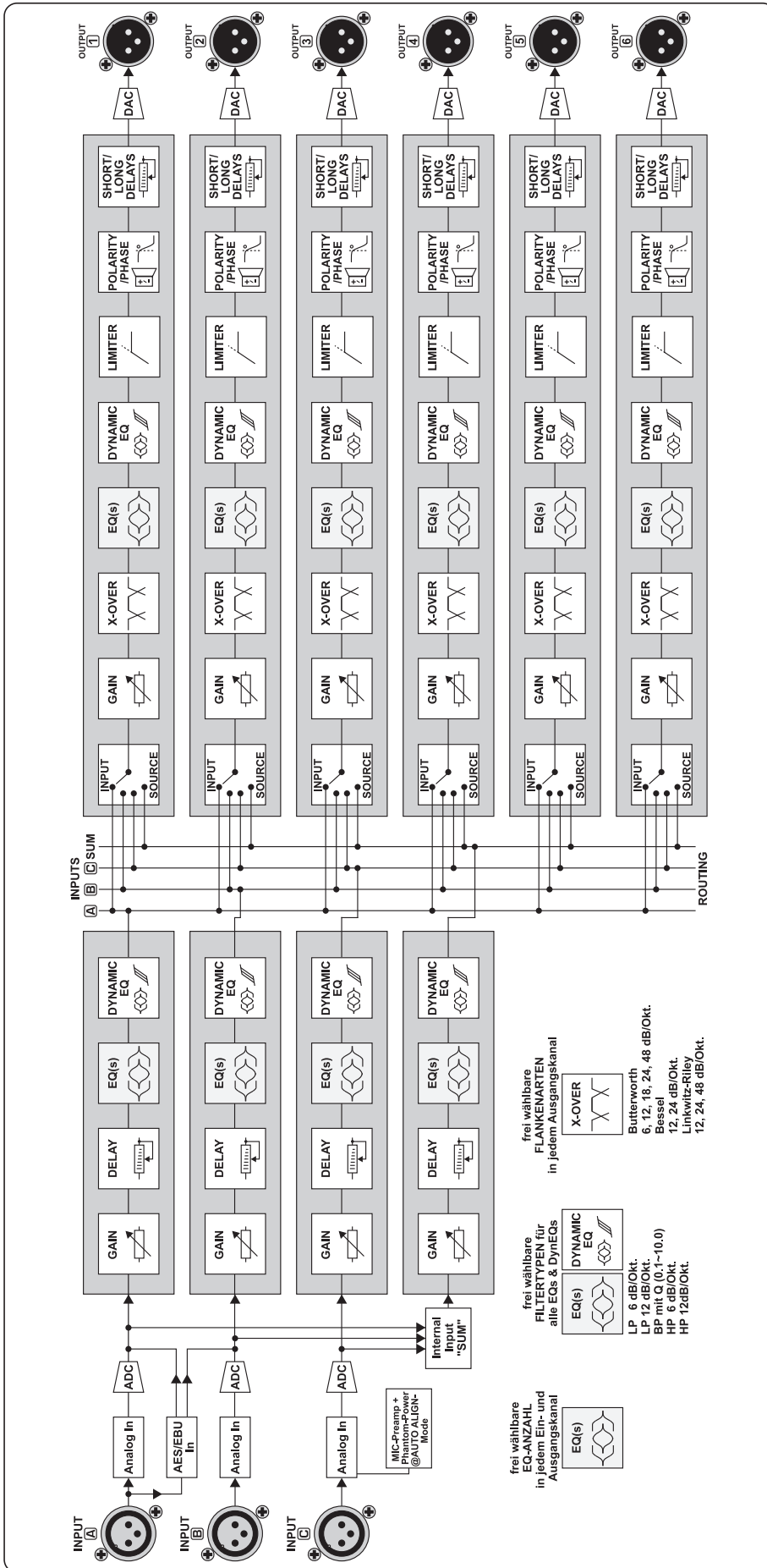

9. Menu Structure

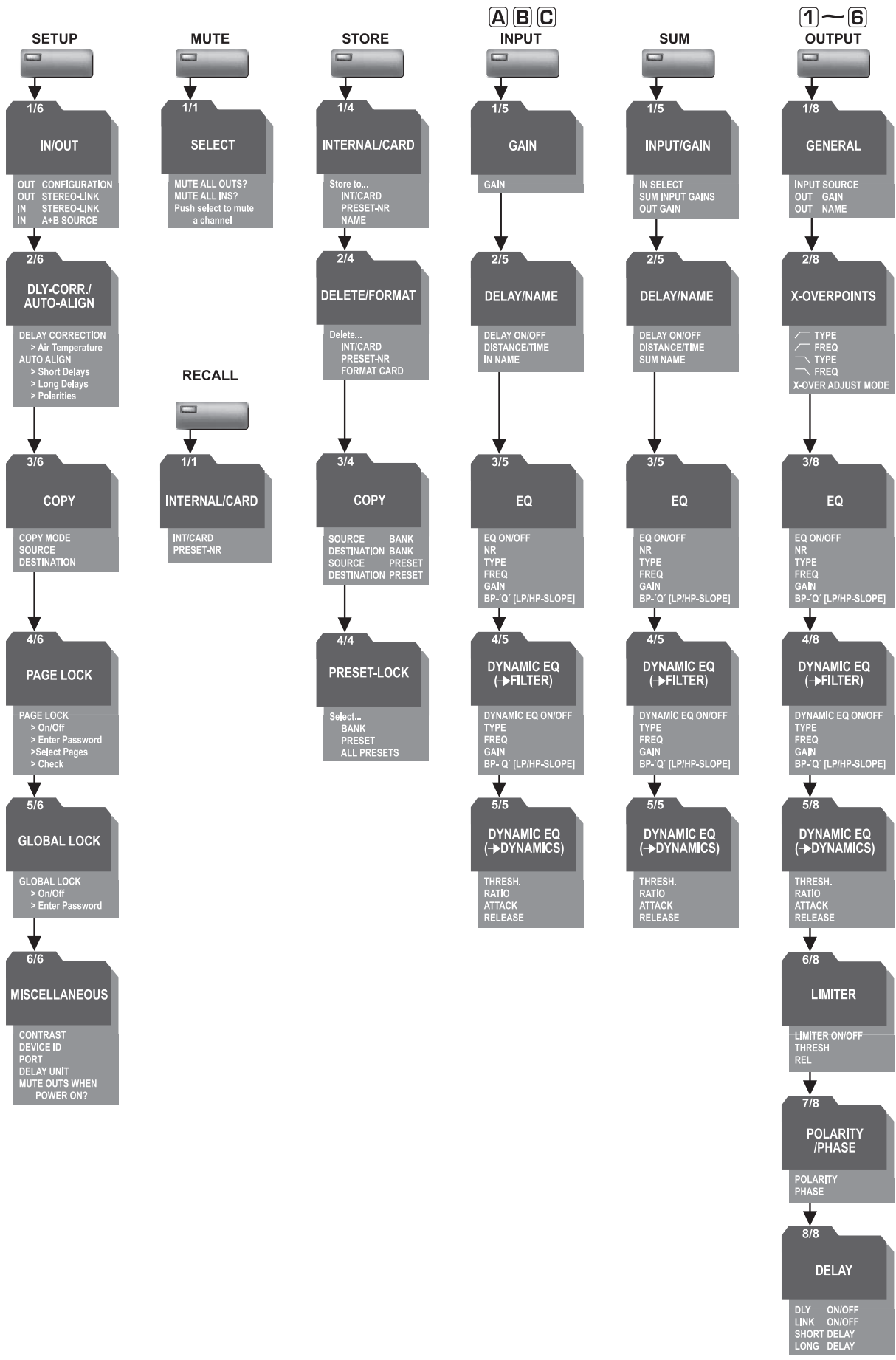

FEDERAL COMMUNICATIONS COMMISSION COMPLIANCE INFORMATION



Responsible Party Name: **MUSIC Group Services US Inc.**
Address: **18912 North Creek Parkway,
Suite 200 Bothell, WA 98011,
USA**
Phone/Fax No.: **Phone: +1 425 672 0816
Fax: +1 425 673 7647**

ULTRADRIVE PRO DCX2496

complies with the FCC rules as mentioned in the following paragraph:

This equipment has been tested and found to comply with the limits for a Class B digital device, pursuant to part 15 of the FCC Rules. These limits are designed to provide reasonable protection against harmful interference in a residential installation. This equipment generates, uses and can radiate radio frequency energy and, if not installed and used in accordance with the instructions, may cause harmful interference to radio communications. However, there is no guarantee that interference will not occur in a particular installation. If this equipment does cause harmful interference to radio or television reception, which can be determined by turning the equipment off and on, the user is encouraged to try to correct the interference by one or more of the following measures:

- Reorient or relocate the receiving antenna.
- Increase the separation between the equipment and receiver.
- Connect the equipment into an outlet on a circuit different from that to which the receiver is connected.
- Consult the dealer or an experienced radio/TV technician for help.

This device complies with Part 15 of the FCC rules. Operation is subject to the following two conditions:

- (1) this device may not cause harmful interference, and
- (2) this device must accept any interference received, including interference that may cause undesired operation.

Important information:

Changes or modifications to the equipment not expressly approved by MUSIC Group can void the user's authority to use the equipment.



We Hear You