

## User's Guide



# Hammerfall<sup>®</sup> DSP System

## HDSP 9632

**DVD**

24 Bit / 192 kHz

*ready*

**TotalMix<sup>™</sup>**



**SyncAlign<sup>®</sup>**

**ZLM<sup>®</sup>**

**SyncCheck<sup>®</sup>**

**SteadyClock<sup>™</sup>**



PCI Busmaster Digital I/O System  
2 + 8 + 2 Channels SPDIF / ADAT / Analog Interface  
24 Bit / 192 kHz Digital Audio  
24 Bit / 192 kHz Stereo Analog Monitor  
MIDI I/O

---

▶ **General**

<b>1</b>	<b>Introduction</b> .....	6
<b>2</b>	<b>Package Contents</b> .....	6
<b>3</b>	<b>System Requirements</b> .....	6
<b>4</b>	<b>Brief Description and Characteristics</b> .....	6
<b>5</b>	<b>Hardware Installation</b> .....	7
<b>6</b>	<b>Hardware – Connectors</b>	
6.1	External Connectors .....	7
6.2	Internal Connectors.....	8
<b>7</b>	<b>Accessories</b> .....	9
<b>8</b>	<b>Warranty</b> .....	9
<b>9</b>	<b>Appendix</b> .....	10

▶ **Driver Installation and Operation - Windows**

<b>10</b>	<b>Driver and Firmware</b>	
10.1	Driver Installation .....	14
10.2	Driver Update .....	14
10.3	Deinstalling the Drivers .....	14
10.4	Firmware Update.....	15
<b>11</b>	<b>Configuring the HDSP 9632</b>	
11.1	Settings Dialog .....	15
11.2	Settings Dialog – DDS .....	18
11.3	Clock Modes – Synchronization.....	19
<b>12</b>	<b>Operation and Usage</b>	
12.1	Playback.....	21
12.2	DVD Playback (AC-3 / DTS) .....	22
12.3	Notes on WDM .....	23
12.4	Multi-client Operation .....	24
12.5	Digital Recording .....	25
12.6	Analog Recording.....	26
<b>13</b>	<b>Operation under ASIO 2.0</b>	
13.1	General .....	26
13.2	Known Problems .....	26
<b>14</b>	<b>Operation under GSIF</b> .....	27
<b>15</b>	<b>Using more than one Hammerfall DSP</b> .....	28
<b>16</b>	<b>DIGICheck</b> .....	28
<b>17</b>	<b>Hotline – Troubleshooting</b>	
17.1	General .....	29
17.2	Installation .....	30
<b>18</b>	<b>Diagrams</b>	
18.1	Channel Routing ASIO 96 kHz .....	31
18.2	Channel Routing WDM 96 kHz .....	32

---

▶ **Driver Installation and Operation - Mac OS X**

<b>19</b>	<b>Driver and Flash Update</b>	
19.1	Driver Installation .....	34
19.2	Driver Update .....	34
19.3	Flash Update.....	34
<b>20</b>	<b>Configuring the HDSP 9632</b>	
20.1	Settings Dialog.....	35
20.2	Settings Dialog – DDS .....	37
20.3	Clock Modes – Synchronization .....	38
<b>21</b>	<b>Mac OS X FAQ</b>	
21.1	Round about Driver Installation .....	40
21.2	MIDI doesn't work .....	40
21.3	Supported Sample Rates.....	41
21.4	Repairing Disk Permissions.....	41
21.5	PCI Compatibility .....	41
21.6	Various Information.....	41
<b>22</b>	<b>Hotline – Troubleshooting</b> .....	42
<b>23</b>	<b>Diagram: Channel Routing at 96 kHz</b> .....	43

▶ **Connections and TotalMix**

<b>24</b>	<b>Analog Connections</b>	
24.1	Line Inputs .....	46
24.2	Line Outputs.....	47
24.3	Phones.....	47
<b>25</b>	<b>Digital Connections</b>	
25.1	ADAT .....	48
25.2	SPDIF.....	48
25.3	MIDI.....	49
<b>26</b>	<b>Word Clock</b>	
26.1	Word Clock Input and Output .....	50
26.2	Technical Description and Background.....	51
26.3	Cables and Termination.....	52
26.4	General Operation.....	52
<b>27</b>	<b>TotalMix: Routing and Monitoring</b>	
27.1	Overview .....	53
27.2	The User Interface .....	55
27.3	Elements of a Channel .....	56
27.4	Tour de TotalMix .....	56
27.5	Submix View .....	56
27.6	Mute and Solo .....	58
27.7	Quick Access Panel .....	59
27.8	Presets .....	59
27.9	Monitor Panel .....	61
27.10	Preferences.....	61
27.11	Editing the Names.....	62
27.12	Hotkeys .....	63
27.13	Menu Options.....	64
27.14	Level Meter .....	65

---

<b>28</b>	<b>TotalMix: The Matrix</b>	
28.1	Overview .....	66
28.2	Elements of the Matrix View .....	66
28.3	Usage .....	66
28.4	Advantages of the Matrix .....	67
<b>29</b>	<b>TotalMix Super-Features</b>	
29.1	ASIO Direct Monitoring (Windows only) .....	67
29.2	Selection and Group based Operation .....	68
29.3	Copy Routings to other Channels .....	68
29.4	Delete Routings .....	68
29.5	Recording a Subgroup (Loopback) .....	69
29.6	Using external Effects Devices .....	70
<b>30</b>	<b>TotalMix MIDI Remote Control</b>	
30.1	Overview .....	71
30.2	Mapping .....	71
30.3	Setup .....	72
30.4	Operation .....	72
30.5	Simple MIDI Control .....	73
30.6	Loopback Detection .....	74

▶ **Technical Reference**

<b>31</b>	<b>Tech Info</b> .....	76
<b>32</b>	<b>Technical Specifications</b>	
32.1	Analog .....	77
32.2	Digital .....	78
32.3	Digital Inputs .....	78
32.4	Digital Outputs .....	79
32.5	MIDI .....	79
<b>33</b>	<b>Technical Background</b>	
33.1	Lock and SyncCheck .....	80
33.2	Latency and Monitoring .....	81
33.3	DS – Double Speed .....	82
33.4	QS – Quad Speed .....	83
33.5	AES/EBU – SPDIF .....	83
33.6	Noise Level in DS / QS Mode .....	84
33.7	SteadyClock .....	84
<b>34</b>	<b>Diagrams</b>	
34.1	Block Diagram HDSP 9632 .....	85
34.2	Connector Pinouts .....	86
34.3	Overview Channels and Expansion Boards .....	87

---

## User's Guide



# HDSP 9632

### ► General

---

## 1. Introduction

Thank you for choosing the RME Hammerfall DSP system. This unique audio system is capable of transferring analog and digital audio data directly to a computer from practically any device. The latest Plug and Play technology guarantees a simple installation, even for the inexperienced user. The numerous unique features and well thought-out configuration dialog puts the Hammerfall DSP at the very top of the range of computer-based audio interfaces.

The package contains drivers for Windows 2000 SP4, Windows XP, Vista /64 and Mac OS X PPC and Intel.

Our high-performance philosophy guarantees maximum system performance by executing as many functions as possible not in the driver (i.e. the CPU), but directly within the audio hardware.

## 2. Package Contents

Please check your Hammerfall DSP system's package contains each of the following:

- HDSP 9632 PCI card
- Quick Info guide
- RME Driver CD
- Digital adapter cable (phono / phono to D-type 9 pin)
- Analog adapter cable (phono / phono / TRS / MIDI to D-type 15 pin)
- Internal cable (2-core)
- 1 optical cable (TOSLINK)

## 3. System Requirements

- Windows 2000 SP4, Windows XP, Mac OS X (10.28 or higher)
- PCI Interface: a free PCI rev. 2.1 Busmaster slot

## 4. Brief Description and Characteristics

- Hammerfall design: 0% (zero!) CPU load, even using all 32 ASIO channels
- All settings can be changed in real-time
- Analog, ADAT and SPDIF I/Os can be used simultaneously
- 8 buffer sizes/latencies available: 1.5 / 3 / 6 / 12 / 23 / 46 / 93 / 186 ms
- 4 channels 96 kHz/24 bit record/playback via ADAT optical (S/MUX)
- Clock modes slave and master
- Automatic and intelligent master/slave clock control
- Unsurpassed Bitclock PLL (audio synchronization) in ADAT mode
- TotalMix for latency-free submixes and perfect ASIO Direct Monitoring
- SyncAlign guarantees sample aligned and never swapping channels
- SyncCheck tests and reports the synchronization status of input signals
- 1 x MIDI I/O, 16 channels high-speed MIDI
- DIGICheck DSP: Level meter in hardware, peak- and RMS calculation
- SteadyClock: Jitter-immune, super-stable digital clock
- TotalMix: 512 channel mixer with 40 bit internal resolution
- Optional word clock input and output

---

## 5. Hardware Installation



Before installing the PCI card, please make sure the computer is switched off and the power cable is disconnected from the mains supply. Inserting or removing a PCI card while the computer is in operation can cause irreparable damage to both motherboard and card!

1. Disconnect the power cord and all other cables from the computer.
2. Remove the computer's housing. Further information on how to do this can be obtained from your computer's instruction manual.
3. Important: Before removing the HDSP 9632 from its protective bag, discharge any static in your body by touching the metal chassis of the PC.
4. Prior to installation: Connect the HDSP 9632 card to any Expansion Board (if present) using the supplied flat ribbon cable. Please read the Expansion Board's manual for more details.
5. Insert the HDSP 9632 firmly into a free PCI slot, press and fasten the screw.
6. If present, insert the Expansion Board(s) and fasten the screw(s).
7. Replace the computer's housing.
8. Reconnect all cables including the power cord.

## 6. Hardware - Connectors

### 6.1 External Connectors

The bracket of the HDSP 9632 has one **ADAT optical** input and output, a **9-pin** and a **15-pin D-type** socket. The included **breakout cable** provides all the analog and digital connections.

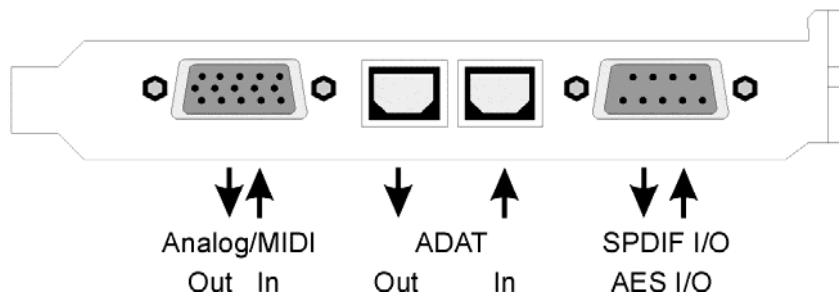

The **ADAT I/O** can also be used as **optical SPDIF I/O**, if set up accordingly in the Settings dialog.

The 9-pin **digital** breakout cable has two **RCA** connectors as coaxial **SPDIF I/O**. The **red** phono socket is the **output**. The breakout cable BO968 (option) has the same RCA connectors, but adds an **XLR AES/EBU** input and output.

The 15-pin **analog** breakout cable has four **RCA** connectors (stereo analog I/O), a 1/4" **TRS** jack (headphones), and two 5-pin **DIN** connectors (MIDI I/O). Using the optional analog XLR breakout cable BO9632-XLRMKH, the HDSP 9632 offers **balanced Line** inputs and outputs via female and male **XLR** connectors.

#### Optional HDSP 9632 Word Clock Module

The expansion board *HDSP 9632 Word Clock Module* provides one word clock input and two word clock outputs. A green LED signals the **LOCK** state of the word clock input stage. A small push switch allows to activate 75 Ohm termination for the word clock input. The yellow LED is lit when termination is active.

#### Optional Analog Expansion Boards AI4S-192 and AO4S-192

These expansion boards increase the number of available channels by four balanced analog inputs and outputs respectively. Thus the HDSP 9632 turns into an I/O solution with eight channels ADAT, two channels SPDIF and six channels analog, a sum of 16 channels in and out. Although not being limited to 96 kHz, the name '19232' did not convince anyone at RME.

---

## 6.2 Internal Connectors

### CD / AEB / SYNC IN

This internal digital input can be used with both SPDIF and ADAT.

#### SPDIF

- Connection to an internal CD-ROM drive with digital audio output. Allows for a direct transfer of digital audio data within the computer.
- Connection to SYNC OUT of another card. This internal SPDIF connection can be used to synchronize multiple cards with sample accuracy, and without the need for an external connection. The card of which SYNC OUT is used will be master, the SYNC IN one will be slave. *SPDIF In / Internal* has to be selected in the Settings dialog. Additionally *Pref. Sync Ref* has to be set to *SPDIF In* for this internal connection to work properly. Please note that the external SPDIF- or AES input can no longer be used.

#### ADAT

- Connection to an AEB4-I or AEB8-I. When using these Expansion Boards ST7 must also be connected to the Expansion Boards. The highest sample rate is 48 kHz. Select *AEB / ADAT Int.* in the Settings dialog. In this mode, the optical input can still be used as optical SPDIF input.
- Connection to a TEB (TDIF Expansion Board). The highest sample rate is 96 kHz, the 4-channel *Double Wire mode (S/MUX)* is automatically activated in Double Speed mode. Select *AEB / ADAT Int.* in the Settings dialog.

#### ADAT OUT

This internal ADAT output carries the same audio data as the optical output ADAT1 in ADAT mode. Connecting an AEB4-O or AEB8-O, the highest sample rate is 48 kHz. Connecting a TEB the highest sample rate is 96 kHz, the 4-channel *Double Wire mode (S/MUX)* is automatically activated. The internal ADAT output stays active, even when the optical output is switched into *SPDIF* operation. Please note the label GND for correct polarity.

#### SYNC OUT

This internal SPDIF output carries the same audio data as the external phono output. It can be used to synchronize multiple cards, see above. Please note the label GND for correct polarity.

#### WORD CLOCK MODULE

10-pin connector for a connection of the optional *HDSP 9632 Word Clock Module* via flat ribbon cable.

#### AI4S-192 / AO4S-192

26-pin connector for the optional analog expansion boards, AI4S-192 and AO4S-192. These expansion boards are detected automatically and self-registered by the driver. The additional channels are displayed automatically in TotalMix as well.

#### Blue Jumper

This is no internal input or output. The blue jumper allows to change the card's power-on delay when booting the computer. Factory default is jumper in place. The FPGA of the HDSP 9632 will then be booted about 0.5 seconds after switching on the computer. This provides an effective way to get rid of problems caused by unstable power supplies in the moment of power-on. In case this delay will become a problem some day (very unlikely, and no system known so far), the jumper can be pulled. The delay is then reduced to 30 ms.



---

## 7. Accessories

RME offers several optional components. Additionally parts of the HDSP 9632, like the special breakout cables, are available separately.

Part Number	Description
36003	Optical cable, TOSLINK, 0.5 m (1.6 ft)
36004	Optical cable, TOSLINK, 1 m (3.3 ft)
36006	Optical cable, TOSLINK, 2 m (6.6 ft)
36007	Optical cable, TOSLINK, 3 m (9.9 ft)
36008	Optical cable, TOSLINK, 5 m (16.4 ft)
36009	Optical cable, TOSLINK, 10 m (33 ft)

Standard lightpipe with TOSLINK connectors, RME approved quality.

BO9632	Breakout cable SPDIF (RCA)
BO968	Breakout cable AES (XLR)
BO9632-CMKH	Breakout cable Analog (RCA)
BO9632-XLRMKH	Breakout cable Analog (XLR)

## 8. Warranty

Each individual Hammerfall DSP undergoes comprehensive quality control and a complete test at IMM before shipping. The usage of high grade components allow us to offer a full two year warranty. We accept a copy of the sales receipt as valid warranty legitimation.

If you suspect that your product is faulty, please contact your local retailer. The warranty does not cover damage caused by improper installation or maltreatment - replacement or repair in such cases can only be carried out at the owner's expense.

Audio AG does not accept claims for damages of any kind, especially consequential damage. Liability is limited to the value of the Hammerfall DSP. The general terms of business drawn up by Audio AG apply at all times.

---

## 9. Appendix

RME news, driver updates and further product information are available on our website:

<http://www.rme-audio.com>

Distributor:

Audio AG, Am Pfanderling 60, D-85778 Haimhausen, Tel.: (49) 08133 / 91810

Manufacturer:

IMM Elektronik GmbH, Leipziger Strasse 32, D-09648 Mittweida

### Trademarks

All trademarks, registered or otherwise, are the property of their respective owners. RME, DIGI96, SyncAlign, ZLM, SyncCheck, DIGICheck and Hammerfall are registered trademarks of RME Intelligent Audio Solutions. HDSP 9632, TMS and TotalMix are trademarks of RME Intelligent Audio Solutions. Alesis and ADAT are registered trademarks of Alesis Corp. ADAT optical is a trademark of Alesis Corp. Microsoft, Windows 2000 and Windows XP are registered trademarks or trademarks of Microsoft Corp. Steinberg, Cubase and VST are registered trademarks of Steinberg Media Technologies GmbH. ASIO is a trademark of Steinberg Media Technologies GmbH.

Copyright © Matthias Carstens, 12/2007. Version 1.3

Current driver version: W2k/XP: 3.056, Mac OS X: 1.71

Although the contents of this User's Guide have been thoroughly checked for errors, RME can not guarantee that it is correct throughout. RME does not accept responsibility for any misleading or incorrect information within this guide. Lending or copying any part of the guide or the RME Driver CD, or any commercial exploitation of these media without express written permission from RME Intelligent Audio Solutions is prohibited. RME reserves the right to change specifications at any time without notice.

---

## CE / FCC Compliance

### CE

This device has been tested and found to comply with the limits of the European Council Directive on the approximation of the laws of the member states relating to electromagnetic compatibility according to RL89/336/EWG and RL73/23/EWG.

### FCC

This equipment has been tested and found to comply with the limits for a Class B digital device, pursuant to Part 15 of the FCC Rules. These limits are designed to provide reasonable protection against harmful interference in a residential installation. This equipment generates, uses, and can radiate radio frequency energy and, if not installed and used in accordance with the instructions, may cause harmful interference to radio communications. However, there is no guarantee that interference will not occur in a particular installation. If this equipment does cause harmful interference to radio or television reception, which can be determined by turning the equipment off and on, the user is encouraged to try to correct the interference by one or more of the following measures:

- Reorient or relocate the receiving antenna.
- Increase the separation between the equipment and receiver.
- Connect the equipment into an outlet on a circuit different from that to which the receiver is connected.
- Consult the dealer or an experienced radio/TV technician for help.

### RoHS

This product has been soldered lead-free and fulfils the requirements of the RoHS directive.

### ISO 9001

This product has been manufactured under ISO 9001 quality management. The manufacturer, IMM Elektronik GmbH, is also certified for ISO 14001 (Environment) and ISO 13485 (medical devices).

## Note on Disposal

According to the guide line RL2002/96/EG (WEEE – Directive on Waste Electrical and Electronic Equipment), valid for all european countries, this product has to be recycled at the end of its lifetime.

In case a disposal of electronic waste is not possible, the recycling can also be done by IMM Elektronik GmbH, the manufacturer of the HDSP 9632I.



For this the device has to be sent **free to the door** to:

IMM Elektronik GmbH  
Leipziger Straße 32  
D-09648 Mittweida  
Germany

Shipments not prepaid will be rejected and returned on the original sender's costs.



---

## User's Guide



# HDSP 9632

### ▶ Driver Installation and Operation - Windows

---

## 10. Driver and Firmware

### 10.1 Driver Installation

After the PCI card has been installed correctly (see 5. Hardware Installation), and the computer has been switched on, Windows will recognize the new hardware component and start its 'Hardware Wizard'. Insert the RME Driver CD into your CD-ROM drive, and follow further instructions which appear on your computer screen. The driver files are located in the directory **WDM** on the RME Driver CD.

Windows will install the Hammerfall DSP System driver, and will register the card in the system as a new audio device. After a reboot the HDSP 9632 is ready for use.

In case the warning messages 'Digital signature not found', 'Do not install driver', 'not certified driver' or similar come up: Don't listen to Microsoft, listen to us and continue with the installation.



*In case the Hardware Wizard does not show up automatically after installation of the card, do not attempt to install the drivers manually! An installation of drivers for non-recognized hardware will cause a blue screen when booting Windows!*

### 10.2 Driver Update

RME's driver updates often include a new hdsp.inf file. Also the revision number of the hardware might change (after a flash update). To prevent Windows 2000/XP from using an old hdsp.inf, or to copy some of the old driver files, be sure NOT to let Windows search for the driver! Instead tell Windows what to do.

Under *>Control Panel /System /Device Manager /Sound, Video and Game Controllers /RME Hammerfall DSP /Properties /Driver<* you'll find the 'Update Driver' button. Select **'Install from a list or specific location (advanced)'**, click **'Next'**, select **'Don't search I will choose the driver to install'**, click **'Next'**, then **'Have Disk'**. Now point to the driver update's directory.

This method also allows to install older drivers than the currently installed ones.

### 10.3 Deinstalling the Drivers

A deinstallation of the HDSP's driver files is not necessary – and not supported by Windows anyway. Thanks to full Plug & Play support, the driver files will not be loaded after the hardware has been removed. If desired these files can then be deleted manually.

Unfortunately Windows Plug & Play methods do not cover the additional autorun entries of TotalMix, the Settings dialog, and the registration of the ASIO driver. Those entries can be removed from the registry through a software deinstallation request. This request can be found (like all deinstallation entries) in *Control Panel, Software*. Click on the entry 'RME Hammerfall DSP (WDM)'.

---

## 10.4 Firmware Update

The Flash Update Tool updates the HDSP 9632 to the latest firmware version. It requires an already installed driver.

Start the program **hdsp\_fut.exe**. The Flash Update Tool displays the current revision of the HDSP 9632, and whether it needs an update or not. If so, then please press the 'Update' button. A progress bar will indicate when the flash process is finished. The bar moves slowly first (program), then faster (verify).

If more than one interface card is installed, all cards can be flashed by changing to the next tab and repeating the process.

After the update the PCI card need to be resettet. This is done by powering down and shutting off the PC. A warm boot is not enough!

When the update fails (status: failure), the card's second BIOS will be used from the next cold boot on (Secure BIOS Technology). Therefore the card stays fully functional. The flash process should then be tried again on a different computer.

Note: Because of the changed hardware revision, Windows 2000/XP will start the hardware assistant and wants to install new drivers. Do NOT let Windows search for new drivers, but follow the instructions given in chapter 10.2.

## 11. Configuring the HDSP 9632

### 11.1 Settings Dialog

Configuration of the HDSP system HDSP 9632 is done via its own settings dialog. The panel 'Settings' can be opened:

- by clicking on the hammer symbol in the Task Bar's system tray

The mixer of the Hammerfall DSP Systems (TotalMix) can be opened:

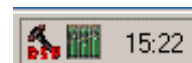

- by clicking on the mixer icon in the Task Bar's system tray

The hardware of the HDSP system offers a number of helpful, well thought-of practical functions and options which affect how the card operates - it can be configured to suit many different requirements. The following is available in the 'Settings' dialog:

- Input selection
- Level of analog I/Os
- Configuration of digital I/Os
- Synchronization behaviour
- State of input and output
- Current sample rate
- Latency

Any changes made in the Settings dialog are applied immediately - confirmation (e.g. by clicking on OK or exiting the dialog) is not required. However, settings should not be changed during playback or record if it can be avoided, as this can cause unwanted noises. Also, please note that even in 'Stop' mode, several programs keep the recording and playback devices open, which means that any new settings might not be applied immediately.

The status displays at the bottom of the dialog box give the user precise information about the current status of the system, and the status of all digital signals.

## Options

*SyncAlign* guarantees synchronous channels when using WDM multitrack software. This option should only be switched off in case the used software does not work correctly with *SyncAlign* activated.

*AEB* activates the internal connector as ADAT input instead of the optical TOSLINK. An expansion board (AEB4-I, AEB8-I, TEB) can be connected here.

## Buffer Size

The setting *Buffer Size* determines the latency between incoming and outgoing ASIO and GSIF data, as well as affecting system stability (see chapter 13/14). Under Windows MME this setting determines the DMA buffer size (see chapter 12.3).

## SyncCheck

*SyncCheck* indicates whether there is a valid signal (Lock, No Lock) for each input (Word Clock, ADAT, SPDIF), or if there is a valid *and* synchronous signal (Sync). The *AutoSync Reference* display shows the input and frequency of the current sync source.

## SPDIF In

Defines the input for the SPDIF signal. 'Optical' relates to the optical TOSLINK input, 'Coaxial' to the RCA socket, 'Internal' to the jumper CD/AEB/SYNC IN, 'AES' to the optional XLR cable.

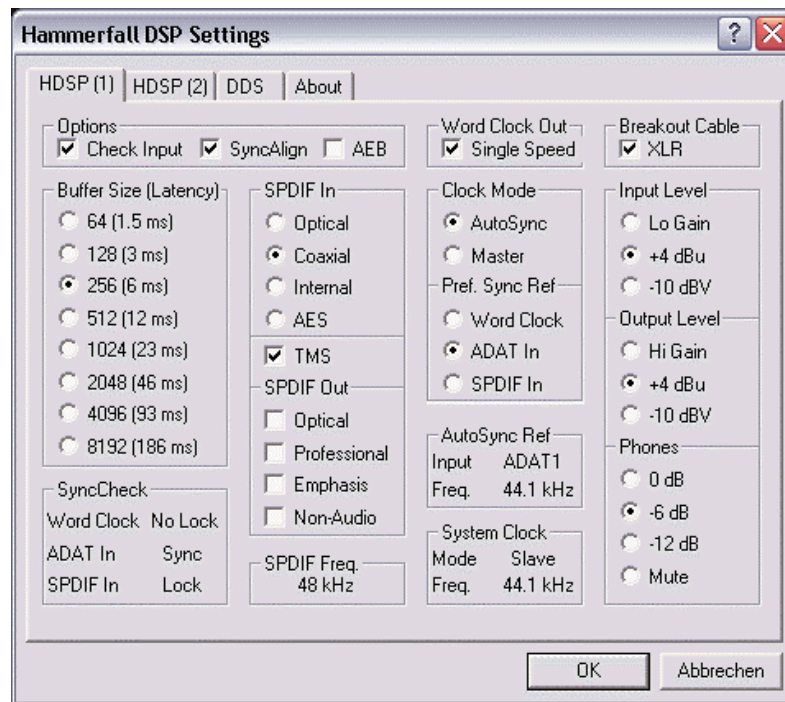

*TMS* activates the transmission of Channel Status data and Track Marker information of the SPDIF input.

## SPDIF Out

The SPDIF output signal is constantly available at the phono plug. After selecting 'Optical' it is also routed to the optical TOSLINK output. For further details about the settings 'Professional', 'Emphasis' and 'Non-Audio', please refer to chapter 25.2.

## SPDIF Freq.

Displays the sample rate of the signal at the SPDIF input.

## Word Clock Out

The word clock output signal usually equals the current sample rate. Selecting *Single Speed* causes the output signal to always stay within the range of 32 kHz to 48 kHz. So at 96 kHz sample rate, the output word clock is 48 kHz.

## Clock Mode

The unit can be configured to use its internal clock source (Master), or the clock source pre-defined via *Pref. Sync Ref* (AutoSync).



### Pref. Sync Ref.

Used to pre-select the desired clock source. If the selected source isn't available, the unit will change to the next available one. The current clock source and sample rate is displayed in the *AutoSync Ref* display.

The automatic clock selection checks and changes between the clock sources Word Clock, ADAT and SPDIF.

### System Clock

Shows the current clock state of the HDSP system. The system is either Master (using its own clock) or Slave (see AutoSync Ref).

### Breakout Cable

Checking 'XLR' lowers the analog Line output level by 6 dB. Using the balanced XLR output cable then results in correct reference levels.

### Input Level

Choice of the reference level and with this of the sensitivity of the analog Line input.

### Output Level

Choice of the reference level and with this of the level at the analog Line output.

### Phones

The volume at the headphone output can be adjusted separately from the Line output. The signal can be lowered by 6 or 12 dB, or completely switched off via Mute.

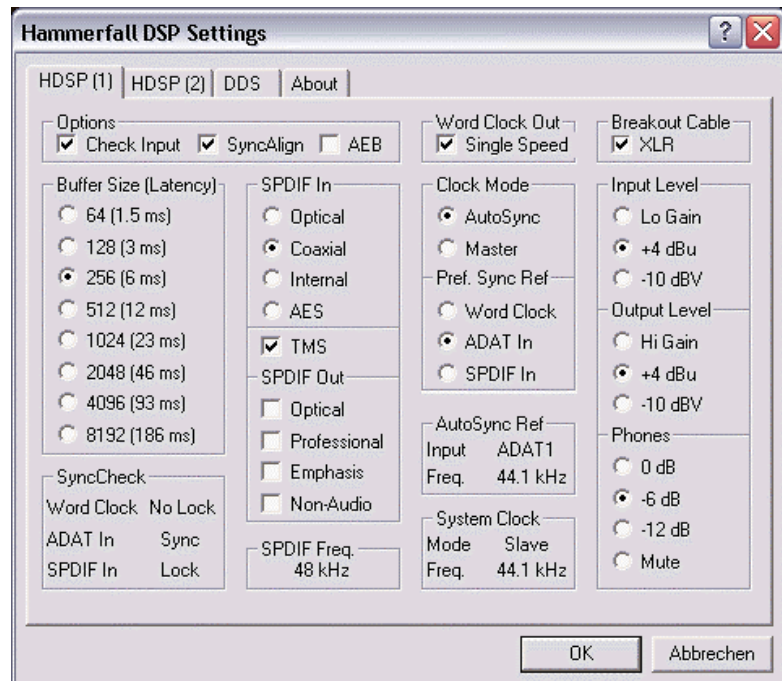

## 11.2 Settings dialog - DDS

Usually soundcards and audio interfaces generate their internal clock (master mode) by a quartz. Therefore the internal clock can be set to 44.1 kHz or 48 kHz, but not to a value in between. SteadyClock, RME's sensational Low Jitter Clock System, is based on a *Direct Digital Synthesizer* (DDS). This superior circuitry can generate nearly any frequency with highest precision.

DDS has been implemented into the HDSP 9632 with regard to the needs of professional video applications, as well as to maximum flexibility. The dialog DDS includes both a list of typical video frequencies (so called pull up/pull down at 0.1% and 4%) and two faders, which allow to freely change the basic sample rate in steps of 1 Hz (!).

 *The DDS dialog requires the HDSP 9632 to be in clock mode Master! The frequency setting will only be applied to this one specific card!*

 *Changing the sample rate in bigger steps during record/playback often results in a loss of audio, or brings up warning messages of the audio software. Therefore the desired sample rate should be set at least coarsely before starting the software.*

### DDS

Activates all settings of this dialog.

#### Value

Shows the sample rate as adjusted in this dialog. The sample rate is defined by the basic setting (Frequency), the multiplier, and the position of the activated fader.

#### Frequency

Sets a fixed basic sample rate, which can be modified by multiplier and fader.

#### Freq. Multiplier

Changes the basic sample rate into Single, Double oder Quad Speed mode.

#### Coarse

Fader for coarse modification of the basic sample rate. Click *Active* to activate it. Minimum step size 1 Hz.

#### Fine

Fader for fine modification of the basic sample rate. Click *Active* to activate it. Minimum step size 1 Hz.

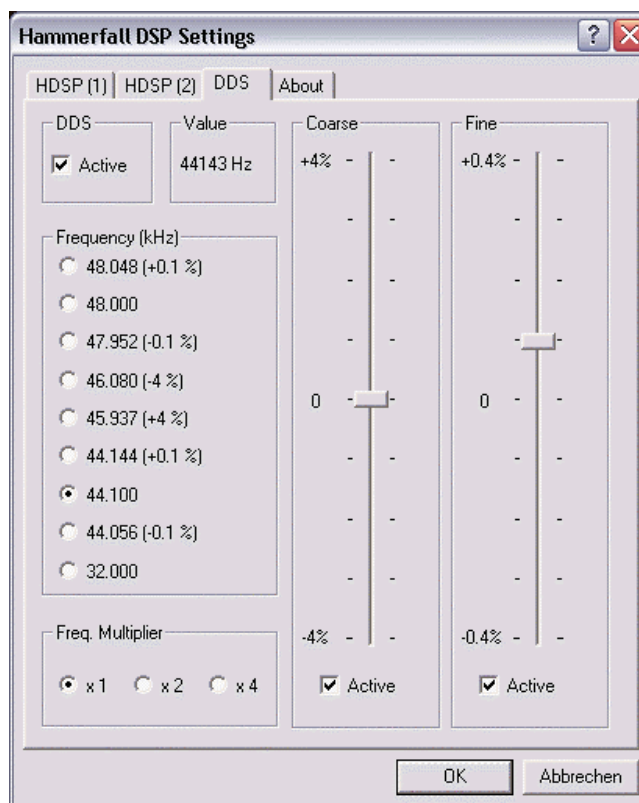

#### Notes on the faders

A mouse click within the fader area, above or below the fader knob, will move the fader with the smallest step size up or down. Holding the Ctrl key while clicking will cause the fader to jump to its center (0).

## Application examples

DDS allows for a simultaneous change of speed and tune during record and playback. From alignment to other sources up to creative effects – everything is possible..

DDS allows to intentionally de-tune the complete DAW. This way, the DAW can match instruments which have a wrong or unchangeable tuning.

DDS allows to define a specific sample rate. This feature can be useful in case the system randomly changes the sample rate – for unknown reasons. It also prevents a change from Double Speed (96 kHz) to Single Speed (48 kHz), which would cause configuration and routing problems by the changed amount of ADAT channels.

## 11.3 Clock Modes - Synchronisation

In the digital world, all devices are either the 'Master' (clock source) or a 'Slave' synchronized to the master. Whenever several devices are linked within a system, there must always be a single master clock. The Hammerfall DSP's intelligent clock control is very user-friendly, being able to switch between clock modes automatically. Selecting **AutoSync** will activate this mode.

In AutoSync mode, the system constantly scans all digital inputs for a valid signal. If this signal corresponds with the current playback sample rate, the card switches from the internal quartz (AutoSync Ref displays 'Master') to a clock generated from the input signal (AutoSync Ref displays 'Slave'). This allows on-the-fly recording, even during playback, without having to synchronize the card to the input signal first. It also allows immediate playback at any sample rate without having to reconfigure the card.

AutoSync guarantees that normal record and record-while-play will always work correctly. In certain cases however, e.g. when the inputs and outputs of a DAT machine are connected directly to the Hammerfall DSP, AutoSync may cause feedback in the digital carrier, so synchronization breaks down. To remedy this, switch the HDSP's clock mode over to 'Master'.

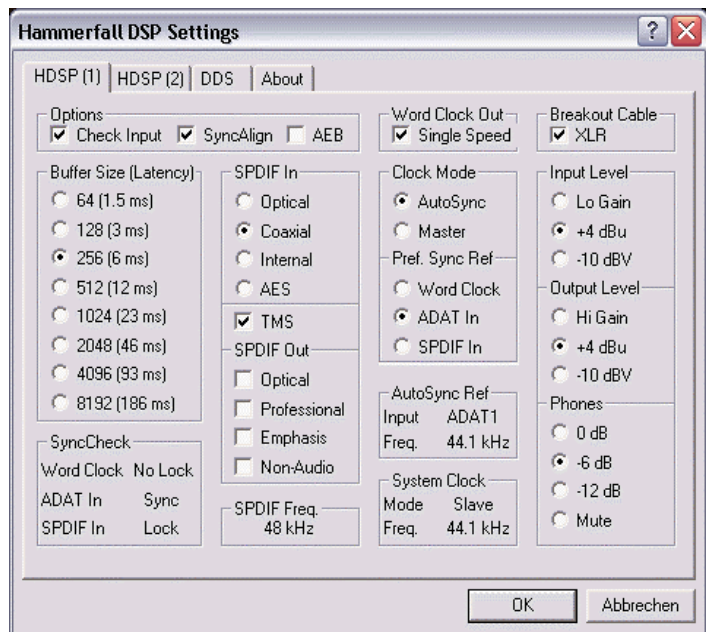

*Remember that a digital system can only have one master! If the HDSP's clock mode is set to 'Master', all other devices must be set to 'Slave'.*

The Hammerfall DSP's ADAT optical input and the SPDIF input operate simultaneously. Because there is no input selector however, the HDSP has to be told which of the signals is the sync reference (a digital device can only be clocked from a *single* source). This is why the system has been equipped with automatic clock source selection, which adopts the first available input with a valid digital signal as the clock reference input. The input currently used as sync reference is shown in the *AutoSync Ref* status field, together with its sample frequency.

---

Via *Pref. Sync Ref* (preferred synchronization reference) a preferred input can be defined. As long as the card sees a valid signal there, this input will be designated as the sync source, otherwise the other inputs will be scanned in turn. If none of the inputs are receiving a valid signal, the card automatically switches clock mode to 'Master'.

To cope with some situations which may arise in studio practice, setting 'Pref Sync Ref' is essential. One example: An ADAT recorder is connected to the ADAT input (ADAT immediately becomes the sync source) and a CD player is connected to the SPDIF input. Try recording a few samples from the CD and you will be disappointed. Few CD players can be synchronized. The samples will inevitably be corrupted, because the signal from the CD player is read with the (wrong) clock from the ADAT i.e. out of sync. In this case, 'Pref Sync Ref' should be temporarily set to SPDIF.

If several digital devices are to be used simultaneously in a system, they not only have to operate with the same sample frequency but also be synchronous with each other. This is why digital systems always need a single device defined as 'master', which sends the same clock signal to all the other ('slave') devices.

RME's exclusive **SyncCheck** technology (first implemented in the Hammerfall) enables an easy to use check and display of the current clock status. The 'SyncCheck' field indicates whether no signal ('No Lock'), a valid signal ('Lock') or a valid *and* synchronous signal ('Sync') is present at each of the digital clock source inputs. The 'AutoSync Ref' display shows the current sync source and the measured frequency.

In practice, SyncCheck provides the user with an easy way of checking whether all digital devices connected to the system are properly configured. With SyncCheck, finally anyone can master this common source of error, previously one of the most complex issues in the digital studio world.

Thanks to its AutoSync technique and lightning fast PLLs, the HDSP is not only capable of handling standard frequencies, but also any sample rate between 28 and 200 kHz. Even the word clock input, which most users will use in varispeed operation, allows any frequency between 28 kHz and 200 kHz.

At 88.2 or 96 kHz: If one of the ADAT inputs has been selected in *Pref Sync Ref*, the sample frequency shown in the field *SPDIF Freq.* differs from the one shown in *AutoSync Ref*. The card automatically switches to S/MUX mode here, because ADAT optical inputs and outputs are only specified up to 48 kHz. Data from/to a single input/output is spread over two channels, the internal frequency stays at 44.1 or 48 kHz. In such cases, the ADAT sample frequency is only half the SPDIF frequency.

## 12. Operation and Usage

### 12.1 Playback

The HDSP system can play back audio data only in supported modes (channels, PCM) and formats (sample rate, bit resolution). Otherwise an error message appears (for example at 22 kHz and 8 bit).

In the audio application being used, HDSP must be selected as output device. This can often be found in the *Options*, *Preferences* or *Settings* menus under *Playback Device*, *Audio Devices*, *Audio* etc.

We strongly recommend switching off all system sounds (via >*Control Panel /Sounds*<). Also HDSP should not be the *Preferred Device* for playback, as this could cause loss of synchronization and unwanted noises. If you feel you cannot do without system sounds, you should consider buying a cheap Blaster clone and select this as *Preferred Device* in >*Control Panel /Multimedia /Audio*<.

The screenshot shows a typical configuration dialog of a (stereo) wave editor. After selecting a device, audio data is sent to an analog or digital (ADAT / SPDIF) port, depending on which has been selected as playback device.

Increasing the number and/or size of audio buffers may prevent the audio signal from breaking up, but also increases latency i.e. output is delayed. For synchronized playback of audio and MIDI (or similar), be sure to activate the checkbox 'Get position from audio driver'.

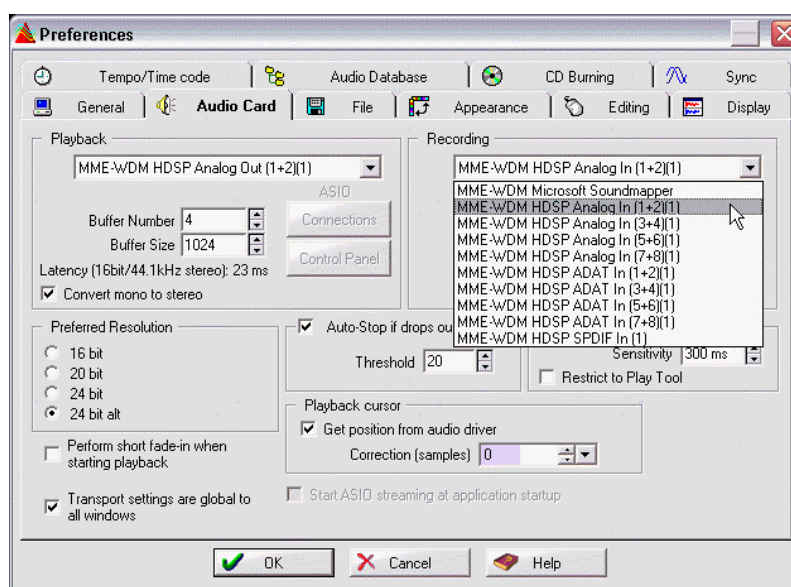

The HDSP system's ADAT optical interface allows sample rates of up to 96 kHz using a standard ADAT recorder. Single-channel data at this frequency requires two ADAT channels, achieved using the *Sample Multiplexing* technique. This reduces the number of available ADAT channels from 8 to 4. Under Windows MME, channels are routed to ADAT devices in double-speed mode as follows:

- Only stereo pairs (1+2) and (3+4) of the ADAT port are available

This kind of implementation allows a problem-free usage of the ADAT port in both Single and Double Speed, as the routing doesn't change. However, the hardware spreads the data differently: Channel 1 is transmitted via channels 1 and 2, channel 2 via 3 and 4 etc.

Please refer to the diagram in chapter 18.2. Routing for record and playback is identical.

---

## 12.2 DVD-Playback (AC-3/DTS) under MME

### AC-3 / DTS

When using popular DVD software player like *WinDVD* and *PowerDVD*, their audio data stream can be sent to any AC-3/DTS capable receiver, using the Hammerfall DSP's SPDIF output. For this to work the SPDIF output wave device has to be selected in *>Control Panel/ Sounds and Multimedia/ Audio<*. Also check 'use preferred device only'.

You will notice that the DVD software's audio properties now allow to use 'SPDIF Out', 'Use SPDIF' or to 'activate SPDIF output'. When selecting these, the software will transfer the non-decoded digital multichannel data stream to the Hammerfall DSP.

This 'SPDIF' signal sounds like chopped noise at highest level. Therefore the HDSP 9632 automatically sets the non-audio bit within the digital data stream, to prevent most SPDIF receivers from accepting the signal, and to prevent any attached equipment from being damaged.

### Multichannel

PowerDVD can also operate as software decoder, sending a DVD's multichannel data stream directly to the analog outputs of the HDSP 9632. Supported are all modes, from 2 to 8 channels, at 16 bit resolution and 48 kHz sample rate. Playback via the ADAT output of the HDSP 9632 is also supported.

For this to work the option *Interleaved* has to be activated in the Settings dialog, an output wave device of the HDSP has to be selected in *>Control Panel/ Sounds and Audio Devices/ Audio<*, and 'Use only default devices' has to be checked. Additionally the loudspeaker setup, found under *>Volume/ Speaker Settings/ Advanced<* has to be changed from *Stereo* to *5.1 Surround*.

PowerDVD's and Win DVD's audio properties now lists several multichannel modes. If one of these is selected, the software sends the decoded analog multichannel data to the HDSP.

The device selected as *Preferred Playback Device* defines the first playback channel.

The typical channel assignment for surround playback is:

- 1 (first chosen playback channel) - Left
- 2 - Right
- 3 - Center
- 4 - LFE (Low Frequency Effects)
- 5 - SR (Surround Right)
- 6 - SL (Surround Left)

Note 1: Setting the card to be used as system playback device is against common sense, as professional cards are not specialized to play back system sounds, and shouldn't be disturbed by system events. To prevent this, be sure to re-assign this setting after usage, or to disable any system sounds (tab Sounds, scheme 'No audio').

Note 2: The DVD player will be synced backwards from the HDSP card. So when using Auto-Sync and/or word clock, the playback speed and pitch follows the incoming clock signal.

---

## 12.3 Notes on WDM

The driver offers a WDM streaming device per stereo pair, like **HDSP 9632 (1+2)**. WDM streaming is Microsoft's current driver and audio system, directly embedded into the operating system. WDM streaming is nearly unusable for professional music purposes, as all data is processed by the so called Kernel Mixer, causing a latency of at least 30 ms. Additionally, WDM can perform sample rate conversions unnoticed, cause offsets between record and playback data, block channels unintentionally and much more. Therefore, for general operation, RME recommend not to use WDM devices.

WDM streaming also replaces the former DirectSound. Synthesizers and Samplers, which achieved latencies below 10 ms using DirectSound, are forced to use WDM in Windows XP, now operating at high latency. Meanwhile most of these programs support ASIO as low latency driver interface.

Several programs do not offer any direct device selection. Instead they use the *playback device* selected in Windows under <Control Panel/ Sounds and Multimedia/ Audio>. Such software often requires the special functions provided by WDM, and therefore will operate better when using a WDM device. Please note that selecting the HDSP to be used as system playback device is against our recommendations, as professional interfaces should not be disturbed by system events.

The program *Sonar* from Cakewalk is unique in many ways. Sonar uses the so called **WDM Kernel Streaming**, bypassing the WDM mixer, thus achieves a similar performance to ASIO.

Because of the driver's multichannel streaming ability (option Interleaved, see chapter 12.4), Sonar not only finds the stereo device mentioned above, but also the 8-channel interleaved devices, and adds the channel number at the end:

HDSP 9632 (1+2) is the first stereo device

HDSP 9632 (3+4) is the next stereo device

HDSP 9632 (1+2) 3/4 are the channels 3/4 of the first 8-channel interleaved device.

We recommend to not use these special interleaved devices. Also note that it is not possible to use one stereo channel twice (the basic and the interleaved device), even with different applications.

---

## 12.4 Multi-client Operation

RME audio interfaces support multi-client operation. This means several programs can be used at the same time. Also all formats (ASIO, WDM, GSIF) can be used simultaneously. The use of multi-client operation requires to follow two simple rules:

- *Multi-client operation requires identical sample rates!*

I.e. it is not possible to use one software with 44.1 kHz and the other with 48 kHz.

- *Different software can not use the same channels at the same time.*

If for example Cubase uses channels 1/2, this playback pair can't be used in Gigasampler/Studio (GSIF) nor under WDM (WaveLab etc.) anymore. This is no limitation at all, because TotalMix allows any output routing, and with this a playback of multiple software via the same hardware outputs. Note that the inputs can be used simultaneously, as the driver sends the data to all applications at the same time.

### ASIO Multi-client

RME audio interfaces support ASIO multi-client operation. It is possible to use more than one ASIO software at the same time. Again the sample rate has to be identical, and each software has to use its own playback channels. Once again the same inputs can be used simultaneously.

RME's sophisticated tool *DIGICheck* is an exception to this rule. It operates like an ASIO host, using a special technique to access playback channels already occupied. Therefore DIGICheck is able to analyse and display playback data from any software, no matter which format the software uses.

### Multi-Client and Multi-Channel using WDM

The WDM streaming devices of our driver can operate as usual stereo devices, or as 8-channel devices. The option **Interleaved** in the Settings dialog determines the current mode.

*Interleaved not active:* The WDM devices operate as usual stereo devices. The multi-client operation works as described above with WDM, ASIO and GSIF.

*Interleaved active:* The WDM devices can also be used as 8-channel devices. Unfortunately the Kernel Mixer, active with any WDM playback, then always occupies and blocks 8 channels at once, even when WaveLab or the Media Player perform just a stereo playback (2 channels). So:



*If any stereo pair within an 8-channel group is used, the whole 8-channel group is blocked. As a result, no second stereo pair of this group can be used, neither with ASIO nor GSIF.*

The eight 8-channel groups are channels 1 to 8 and 9 to 16.

Starting ASIO or GSIF playback on any of the stereo pairs of an 8-channel group prior to starting a WDM playback will prevent the Kernel Mixer from opening the 8-channel device, as two of its channels are already in use. The Kernel Mixer then automatically reverts to open a stereo device for a stereo playback.



---

## 12.5 Digital Recording

Unlike analog soundcards which produce empty wave files (or noise) when no input signal is present, digital I/O cards always need a valid input signal to start recording.

To take this into account RME included a comprehensive I/O signal status display (showing sample frequency, lock and sync status) in the Settings dialog.

The sample frequency shown in the Settings dialog (see chapter 11, screenshot Settings) is useful as a quick display of the current configuration (the box itself and all connected external equipment). If no sample frequency is recognized, it will read 'No Lock'.

This way, configuring any suitable audio application for digital recording is simple. After selecting the required input, Hammerfall DSP displays the current sample frequency. This parameter can then be changed in the application's audio attributes (or similar) dialog.

The screenshot to the right shows a typical dialog used for changing basic parameters such as sample frequency and resolution in an audio application.

Any bit resolution can be selected, providing it is supported by both the audio hardware and the software. Even if the input signal is 24 bit, the application can still be set to record at 16-bit resolution. The lower 8 bits (and therefore any signals about 96dB below maximum level) are lost entirely. On the other hand, there is nothing to gain from recording a 16-bit signal at 24-bit resolution - this would only waste precious space on the hard disk.

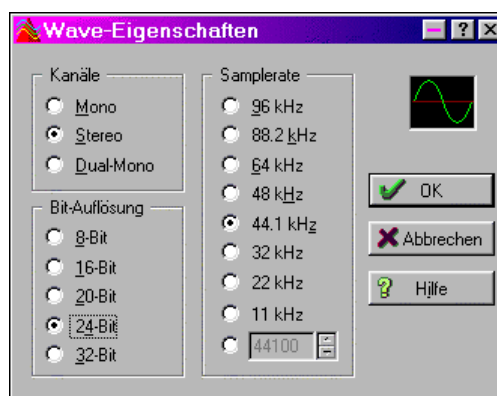

It often makes sense to monitor the input signal or send it directly to the output. This can be done at zero latency using **TotalMix** (see chapter 27).

An *automated* control of real-time monitoring can be achieved by Steinberg's ASIO protocol with our ASIO 2.0 drivers and all ASIO 2.0 compatible programs. When 'ASIO Direct Monitoring' has been switched on, the input signal is routed in real-time to the output whenever a recording is started (punch-in).

**Note:** Under MME the feature 'Check Input' prevented recordings done at wrong sample rates. Under WDM this functionality is limited. With Check Input activated Windows will automatically (and without notice) perform a sample rate conversion. With Check Input deactivated the recording will simply be performed with the wrong sample rate, with a detuned playback later on. Therefore Check Input has been removed from the Settings dialog of the WDM driver.

---

## 12.6 Analog Recording

For recordings via the analog inputs the corresponding record device has to be chosen (HDSP Analog (x+x)).

The input sensitivity of the analog inputs can be adjusted via the Settings dialog to meet the most often used studio levels, see chapter 24.1.

## 13. Operation under ASIO 2.0

### 13.1 General

Start the ASIO software and select **ASIO Hammerfall DSP** as the audio I/O device. The 'ASIO system control' button opens the HDSP's Settings dialog (see chapter 11 / 20, Configuration).

Hammerfall DSP supports *ASIO Direct Monitoring* (ADM). Please note that currently Nuendo, Cubase and Logic either do not support ADM completely or error-free.

At a sample rate of 88.2 or 96 kHz, the ADAT optical input and output operate in S/MUX mode, so the number of available channels is reduced from 8 to 4.

In case of a drift between audio and MIDI, or in case of a fixed deviation (MIDI notes placed close before or behind the correct position), the settings in Cubase/Nuendo have to be changed. At the time of print, the best settings are the use of emulated MIDI driver/ports, and the activation of the option 'Use System Timestamp'.

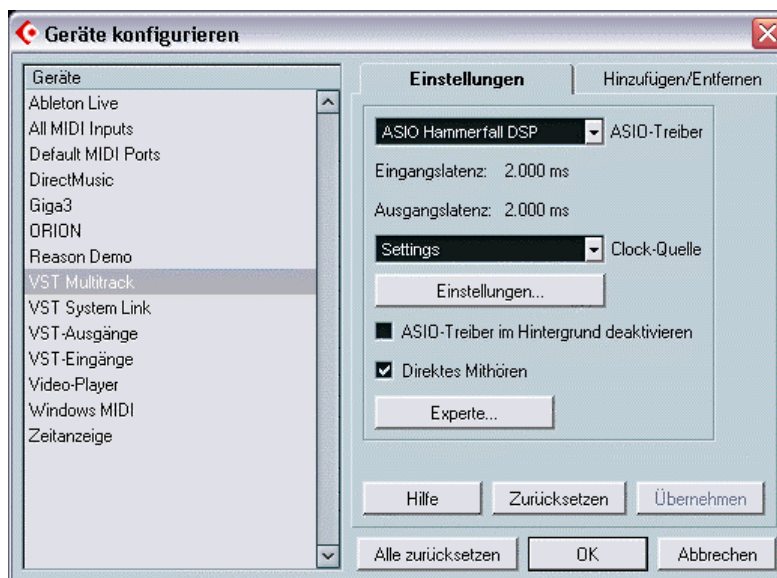

### 13.2 Known Problems

If a computer does not provide sufficient CPU-power and/or sufficient PCI-bus transfer rates, then drop outs, crackling and noise will appear. We recommend to deactivate all PlugIns to verify that these are not the reason for such effects.

Additional hard disk controllers, both on-board and PCI based, often violate the PCI specs. To achieve the highest throughput they hog the PCI bus, even in their default setting. Thus when working with low latencies heavy drop outs (clicks) are heard. Try to solve this problem by changing the default setting of the controller (for example by reducing the 'PCI Bus Utilization').

Another common source of trouble is incorrect synchronization. ASIO does not support asynchronous operation, which means that the input and output signals not only have to use the same sample frequency, but also have to be in sync. All devices connected to the Hammerfall DSP must be properly configured for Full Duplex operation. As long as SyncCheck (in the Settings dialog) only displays *Lock* instead of *Sync*, the devices have not been set up properly!

When using more than one HDSP system, all units have to be in sync, see chapter 15. Else a periodically repeated noise will be heard.

---

## 14. Operation under GSIF (Gigasampler Interface)

### Windows 2000/XP

The GSIF interface of the Hammerfall DSP allows direct operation with Gigastudio, with up to 18 channels, 96 kHz and 24 bit. The new GSIF 2.1 is also supported with both audio and MIDI.

Gigastudio requires a lot of the computer's calculation power. An optimum performance is achieved with a stand-alone GSIF PC. However, when using the Hammerfall DSP, the latency is always the same as the one selected for ASIO operation. This can cause performance problems on slower machines when using GSIF and ASIO at the same time.

Please note that the W2k/XP driver fully supports multi-client operation, including the combination WDM/ASIO. So for example Cubase, Gigastudio and Sonar can be used simultaneously, provided each of these programs uses its own audio channels exclusively. For example ASIO could use channels 1/2 and Gigastudio (with GSIF) channels 3/4 simultaneously, and so on.



*Simultaneous operation of GSIF and ASIO requires to use different channels. For example, if Cubase uses tracks 1/2 these tracks can not be used by Gigastudio.*

### Common Problems

Please note that Gigastudio is running unexpectedly in the background (thus blocking its assigned audio channels), as soon as the Gigastudio MIDI ports are used – even when Gigastudio itself hasn't been started. This causes a lot of confusion, as the driver seems to behave completely buggy, and the user does not recognize the simple reason for it – for example simultaneous operation of ASIO and GSIF on the same channels.

If Gigastudio starts up properly, loads gig files too, but won't play at all even when using the virtual keyboard: Go to *Hardware/Routing* and select a valid MIDI input port. Note that blank is not valid, but <none> is.

---

## 15. Using more than one Hammerfall DSP

The current drivers support operation of up to three Hammerfall DSP systems. All cards of the HDSP and HDSPe systems share the same driver, therefore can be used simultaneously in any combination. Please note that only one *ADAT Sync In* can be used (of course). All units have to be in sync, i.e. have to receive valid sync information either via word clock or by using AutoSync and feeding synchronized signals.

- If one of the HDSP systems is set to clock mode Master, all others have to be set to clock mode AutoSync, and have to be synced from the master, for example by feeding word clock. The clock modes of all units have to be set up correctly in their Settings dialog.
- If all units are fed with a synchronous clock, i.e. all units show *Sync* in their Settings dialog, all channels can be used at once. This is especially easy to handle under ASIO, as the ASIO driver presents all units as one.

Note: TotalMix is part of the hardware of each HDSP system. Up to three mixers are available, but these are separated and can't interchange data. Therefore a global mixer for all units is not possible.

## 16. DIGICheck

The DIGICheck software is a unique utility developed for testing, measuring and analysing digital audio streams. Although this Windows software is fairly self-explanatory, it still includes a comprehensive online help. DIGICheck 4.52 operates as multi-client ASIO host, therefore can be used in parallel to any software, be it MME, ASIO or GSIF, with both inputs and outputs (!). The following is a short summary of the currently available functions:

- **Level Meter.** High precision 24-bit resolution, 2/8/18 channels. Application examples: Peak level measurement, RMS level measurement, over-detection, phase correlation measurement, dynamic range and signal-to-noise ratios, RMS to peak difference (loudness), long term peak measurement, input check. Oversampling mode for levels higher than 0 dBFS. Vertical and horizontal mode. Slow RMS and RLB weighting filter. Supports visualization according to the K-system.
- **Hardware Level Meter for Input, Playback and Output.** As above, received pre-calculated directly from the HDSP system hardware with near zero CPU load.
- **Spectral Analyser.** World wide unique 10-, 20- or 30-band display in analog bandpass-filter technology. 192 kHz-capable!
- **Vector Audio Scope.** World wide unique Goniometer showing the typical afterglow of an oscilloscope-tube. Includes Correlation meter and level meter.
- **Totalyser.** Spectral Analyser, Level Meter and Vector Audio Scope in a single window.
- **Bit Statistics & Noise.** Shows the true resolution of audio signals as well as errors and DC offset. Includes Signal to Noise measurement in dB and dBA, plus DC measurement.
- **Channel Status Display.** Detailed analysis and display of SPDIF and AES/EBU Channel Status data.
- **Global Record.** Long-term recording of all channels at lowest system load.
- **Completely multi-client.** Open as many measurement windows as you like, on any channels and inputs or outputs!

To install DIGICheck, go to the **\DIGICheck** directory on the RME Driver CD and run *setup.exe*. Follow the instructions prompted on the screen.

DIGICheck is constantly improved. The latest version is always found on our website [www.rme-audio.de](http://www.rme-audio.de), section **Downloads/Add-Ons**.

---

## 17. Hotline – Troubleshooting

### 17.1 General

The newest information can always be found on our website [www.rme-audio.com](http://www.rme-audio.com), section FAQ, Latest Additions.

*The input signal cannot be monitored in real-time*

- ASIO Direct Monitoring has not been enabled, and/or monitoring has been disabled globally (for example in TotalMix).

*The 8 ADAT channels don't seem to work*

- The optical output has been switched to *SPDIF*. The ADAT playback devices are still usable by routing and mixing them in TotalMix to other outputs.

*Playback works, but record doesn't*

- Check that there is a valid signal at the input. If so, the current sample frequency is displayed in the Settings dialog.
- Check whether the HDSP system has been selected as recording device in the audio application.
- Check whether the sample frequency set in the audio application ('Recording properties' or similar) matches the input signal.
- Check that cables/devices have not been connected in a closed loop. If so, set the system's clock mode to Master.

*Crackle during record or playback*

- Increase the number and size of buffers in the 'Settings' dialog or in the application.
- Try different cables (coaxial or optical) to rule out any defects here.
- Check that cables/devices have not been connected in a closed loop. If so, set the system's clock mode to 'Master'.
- Increase the buffer size of the hard disk cache.
- Activate Busmaster mode for the hard disks.
- In case of a recently done BIOS update of the motherboard: Probably 'Load BIOS Defaults' was loaded instead of 'Load Setup Defaults'. This sets the 'PCI Latency Timer' to 0 (default: 32).

*Low Latency ASIO operation under Windows 2000/XP on single CPU systems:*

- To use ASIO at lowest latencies under Windows 2000/XP even when only having one CPU, the system performance has to be optimized for background tasks. Go to *>Control Panel/System/Advanced/Performance Options<*. Change the default 'Applications' to 'Background tasks'. The lowest usable latency will drop from 23 ms to around 3 ms.

---

## 17.2 Installation

Hammerfall DSP is found in the Device Manager (>*Settings/ Control Panel/ System*<), category 'Sound-, Video- and Gamecontroller'. A double click on ' HDSP 9632' starts the properties dialog. Choosing 'Resources' shows Interrupt and Memory Range.

The newest information on hardware problems can always be found on our website [www.rme-audio.com](http://www.rme-audio.com), section FAQ, Hardware Alert: about incompatible hardware.

*The dialog 'New hardware component found' does not appear:*

- Check whether the PCI interface is correctly inserted in the PCI slot.

*The card and drivers have been installed correctly, but playback does not work:*

- Check whether the Hammerfall DSP appears in the Device Manager. If the ' Hammerfall DSP' device has a yellow exclamation mark, then there is an address or interrupt conflict.
- Even if there is no yellow exclamation mark, it is worth checking the 'Resources' tab anyway.

## 18. Diagrams

### 18.1 Channel Routing ASIO at 96 kHz

This diagram shows the signal paths in ASIO double speed mode (88.2 / 96 kHz). The devices available via the ASIO driver have been designed to avoid conflicts in normal operation. Record and playback are identical.

Device: The device name in the audio application      SR: Sample Rate  
 Device name code: Channel in ASIO host, interface, HDSP 9632, card number

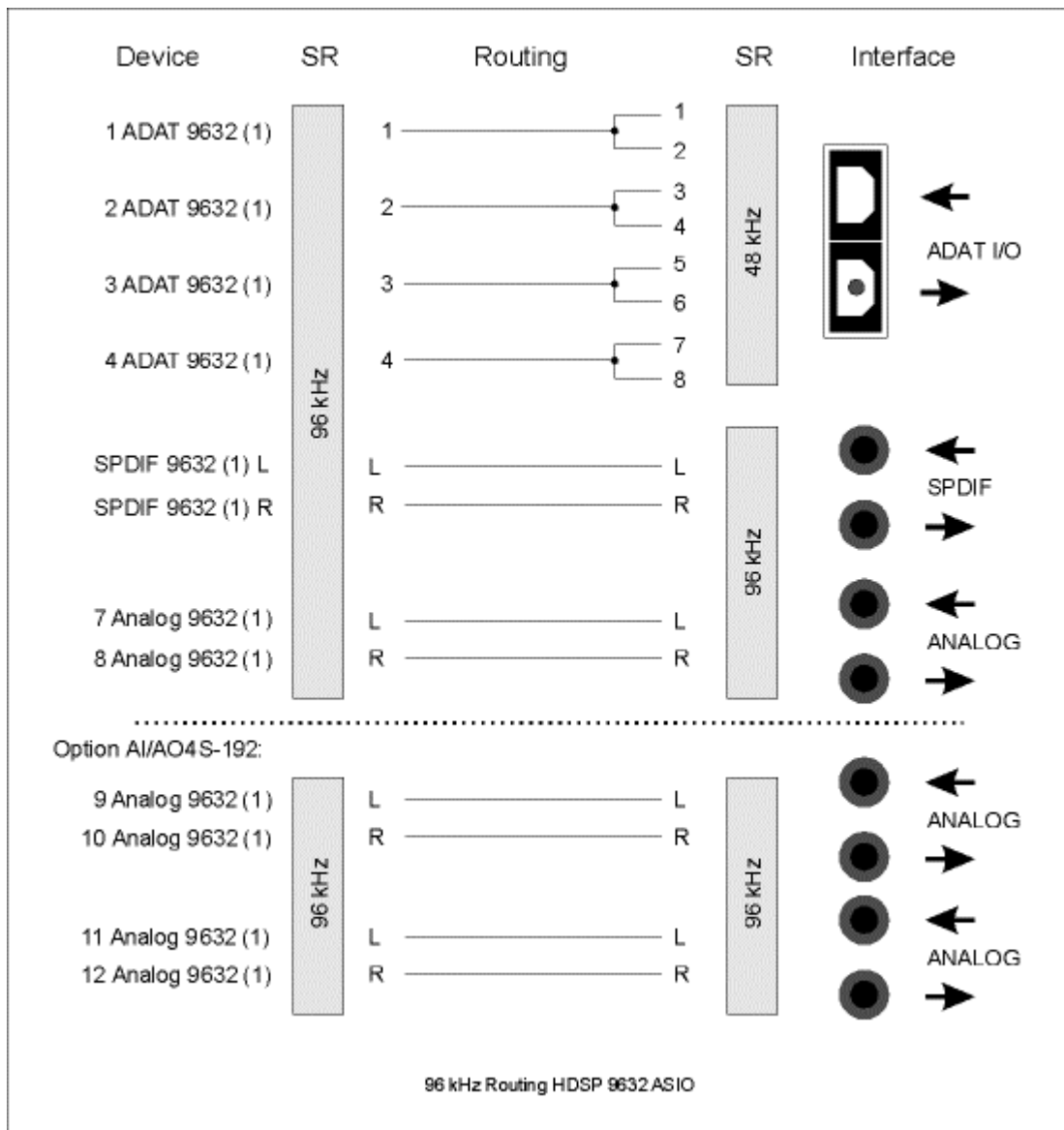

## 18.2 Channel Routing WDM at 96 kHz

This diagram shows the signal paths in MME double speed mode (88.2 / 96 kHz). The devices available via the MME wave driver have been designed to avoid conflicts in normal operation, which is why channels 5, 6, 7 and 8 of the ADAT device have been omitted. Record and playback are identical.

Device: The device name in the audio application

SR: Sample Rate

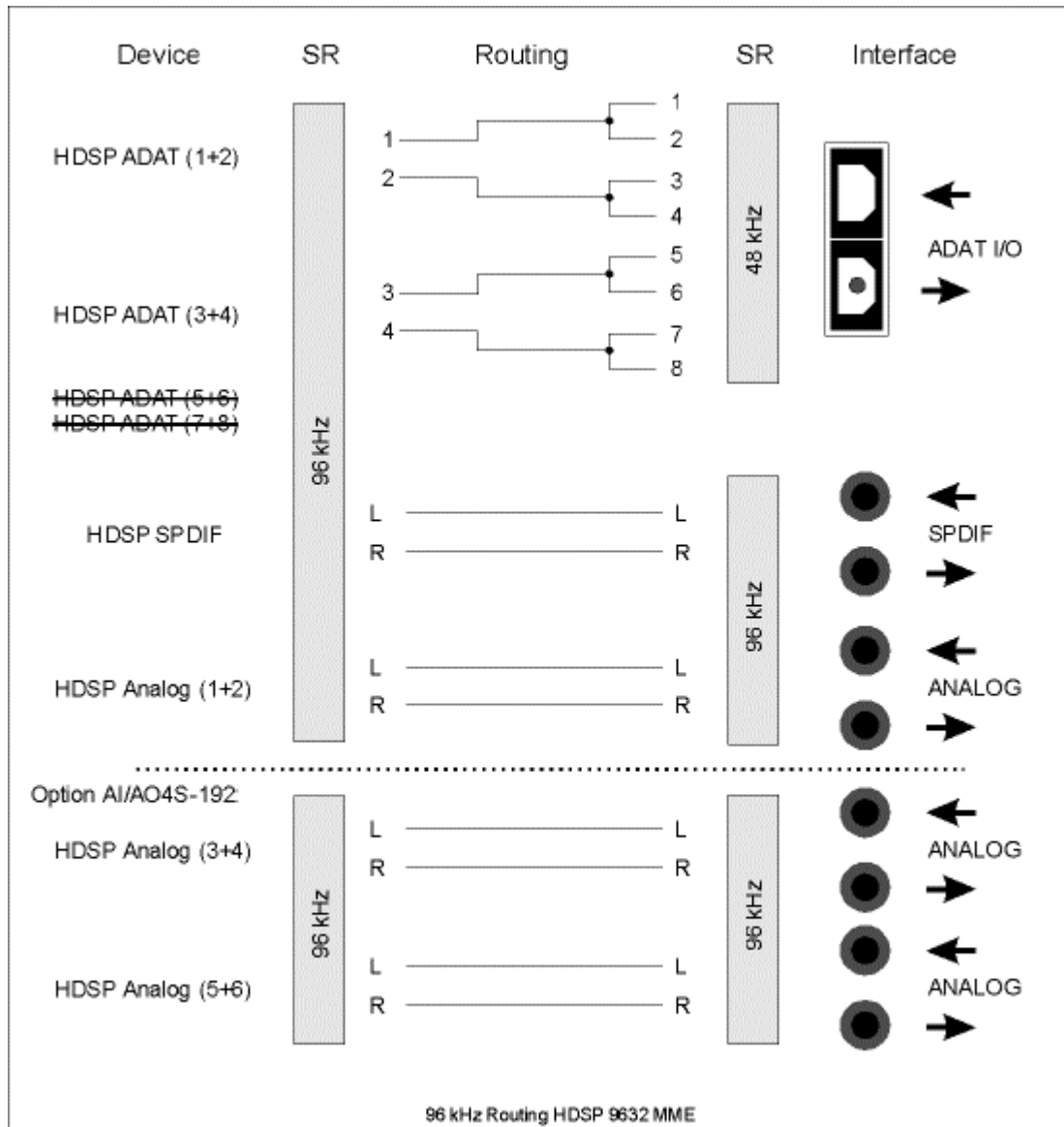



---

## User's Guide



# HDSP 9632

### ▶ Driver Installation and Operation – Mac OS X

---

## 19. Driver and Flash Update

### 19.1 Driver Installation

First fit the card (see 5. Hardware Installation), then switch on the computer and install the drivers from the RME Driver CD. The driver file is located in the folder **Hammerfall DSP**. Installation works automatically by a double-click on the file **hdsp.mpkg**.

RME recommends to download the latest driver version from the RME website! If done, the procedure is as follows:

Double-click onto **hdsp\_xx.gz** to expand the archive file to **hdsp\_xx.tar** and the folder **HDSP\_xx**, which includes the driver file **hdsp.mpkg**. Installation works automatically by a double-click on this file.

During driver installation the programs **Settings** and **Mixer** (TotalMix) will also be installed. Both programs start automatically as soon as a HDSP system is detected. They stay in the dock when exited, and remove themselves automatically from the dock when the HDSP system is removed.

Reboot the computer when installation is done.

### 19.2 Driver Update

In case of a driver update it's not necessary to remove the old driver first, it will be overwritten during the installation.

**Exception: driver updates from version <1.6. Remove the former Settings dialog and TotalMix from the Login Items, and delete both files from your hard drive!**

This driver version did not have the features AutoLoad, Dock Lock and AutoRemove. Therefore one has to make sure that both programs have been removed from the system, to prevent the old Settings dialog and TotalMix from being loaded.

### 19.3 Flash Update

The Flash Update Tool updates the HDSP 9632 card to the latest firmware version. It requires an already installed driver.

Start the program **HDSP Flash**. The Flash Update Tool displays the current revision of the HDSP interface, and whether it needs an update or not. If so, then simply press the 'Update' button. A progress bar will indicate when the flash process is finished. The bar moves slowly first (program), then faster (verify).

If more than one interface card is installed, all cards can be flashed by changing to the next tab and repeating the process.

After the update the PCI card needs to be resetted. This is done by powering down and shutting off the PC. A warm boot is not enough!

When the update fails (status: failure), the card's second BIOS will be used from the next cold boot on (Secure BIOS Technology). Therefore the card stays fully functional. The flash process should then be tried again on a different computer.

---

## 20. Configuring the HDSP 9632

### 20.1 Settings Dialog

Configuring the HDSP 9632 is done via its own settings dialog. The panel 'Settings' can be opened by clicking on the hammer icon in the dock. The mixer of the HDSP 9632, TotalMix, can be opened by clicking on the mixer icon in the dock.

The Hammerfall DSP's hardware offers a number of helpful, well thought-of practical functions and options which affect how the card operates - it can be configured to suit many different requirements. The following is available in the 'Settings' dialog:

- Input selection
- Level of analog I/Os
- Configuration of digital I/Os
- Synchronization behaviour
- State of input and output
- Current sample rate
- Latency

Any changes performed in the Settings dialog are applied immediately - confirmation (e.g. by exiting the dialog) is not required. However, settings should not be changed during playback or record if it can be avoided, as this can cause unwanted noises.

The status displays at the bottom of the dialog box give the user precise information about the current status of the system, and the status of all digital signals.

*SyncCheck* indicates whether there is a valid signal (Lock, No Lock) for each input (Word Clock, ADAT, SPDIF), or if there is a valid *and* synchronous signal (Sync). The *AutoSync Ref(ference)* display shows the input and frequency of the current sync source.

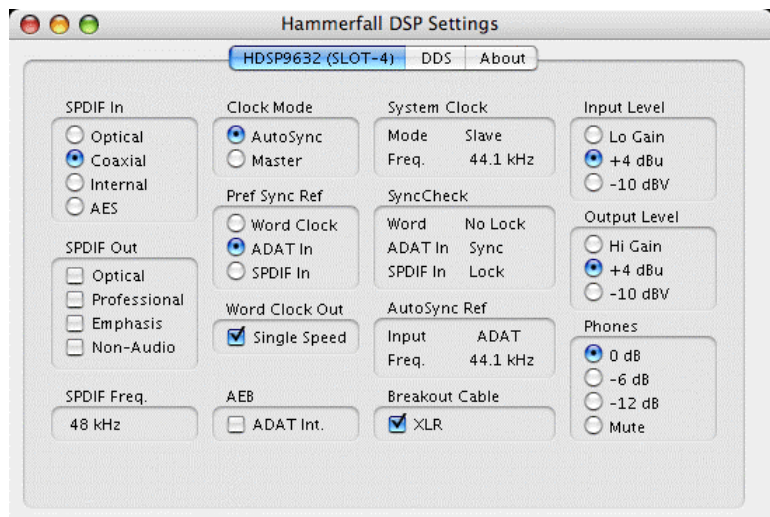

#### SPDIF In

Defines the input for the SPDIF signal. 'Optical' relates to the optical TOSLINK input, 'Coaxial' to the RCA socket, 'Internal' to the jumper CD/AEB/SYNC IN, 'AES' to the optional XLR cable.

#### SPDIF Out

The SPDIF output signal is constantly available at the phono plug. After selecting 'Optical' it is also routed to the optical TOSLINK output. For further details about the settings 'Professional', 'Emphasis' and 'Non-Audio', please refer to chapter 25.2.

#### SPDIF Freq.

Displays the sample rate of the signal at the SPDIF input.

---

## Clock Mode

The unit can be configured to use its internal clock source (Master), or the clock source pre-defined via *Pref Sync Ref* (AutoSync).

## Pref Sync Ref

Used to pre-select the desired clock source. If the selected source isn't available, the unit will change to the next available one. The current clock source and sample rate is displayed in the *AutoSync Ref* display.

The automatic clock selection checks and changes between the clock sources Word Clock, ADAT optical and SPDIF.

## Word Clock Out

The word clock output signal usually equals the current sample rate. Selecting *Single Speed* causes the output signal to always stay within the range of 32 kHz to 48 kHz. So at 96 kHz sample rate, the output word clock is 48 kHz.

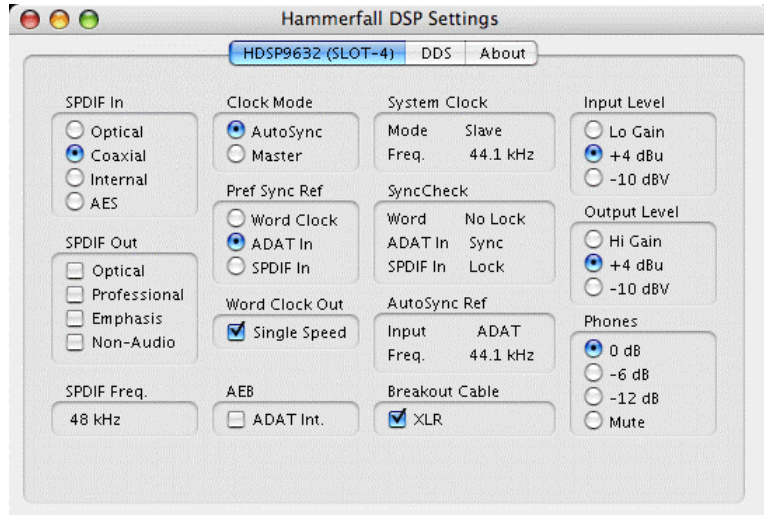

## AEB

AEB activates the internal connector as ADAT input instead of the optical TOSLINK. An expansion board (AEB4-I, AEB8-I, TEB) can be connected here.

## System Clock

Shows the current clock state of the HDSP system. The system is either Master (using its own clock) or Slave (see AutoSync Ref).

## SyncCheck

*SyncCheck* indicates whether there is a valid signal (Lock, No Lock) for each input (Word Clock, ADAT, SPDIF), or if there is a valid *and* synchronous signal (Sync). The *AutoSync Reference* display shows the input and frequency of the current sync source.

## Breakout Cable

Checking 'XLR' lowers the analog Line output level by 6 dB. Using the balanced XLR output cable then results in correct reference levels.

## Input Level

Choice of the reference level and with this of the sensitivity of the analog Line input.

## Output Level

Choice of the reference level and with this of the level at the analog Line output.

## Phones

The volume at the headphone output can be adjusted separately from the Line output. The signal can be lowered by 6 or 12 dB, or completely switched off via Mute.

## 20.2 Settings dialog - DDS

Usually soundcards and audio interfaces generate their internal clock (master mode) by a quartz. Therefore the internal clock can be set to 44.1 kHz or 48 kHz, but not to a value in between. SteadyClock, RME's sensational Low Jitter Clock System, is based on a *Direct Digital Synthesizer* (DDS). This superior circuitry can generate nearly any frequency with highest precision.

DDS has been implemented into the HDSP 9632 with regard to the needs of professional video applications, as well as to maximum flexibility. The dialog DDS includes both a list of typical video frequencies (so called pull up/pull down at 0.1% and 4%) and two faders, which allow to freely change the basic sample rate in steps of 1 Hz (!).

 *The DDS dialog requires the HDSP 9632 to be in clock mode Master! The frequency setting will only be applied to this one specific card!*

 *Changing the sample rate in bigger steps during record/playback often results in a loss of audio, or brings up warning messages of the audio software. Therefore the desired sample rate should be set at least coarsely before starting the software.*

### DDS

Activates all settings of this dialog.

### Value

Shows the sample rate as adjusted in this dialog. The sample rate is defined by the basic setting (Frequency), the multiplier, and the position of the activated fader.

### Frequency

Sets a fixed basic sample rate, which can be modified by multiplier and fader.

### Freq. Multiplier

Changes the basic sample rate into Single, Double oder Quad Speed mode.

### Coarse

Fader for coarse modification of the basic sample rate. Click *Active* to activate it. Minimum step size 1 Hz.

### Fine

Fader for fine modification of the basic sample rate. Click *Active* to activate it. Minimum step size 1 Hz.

### Notes on the faders

A mouse click within the fader area, above or below the fader knob, will move the fader with the smallest step size up or down. Holding the Ctrl key while clicking will cause the fader to jump to its center (0).

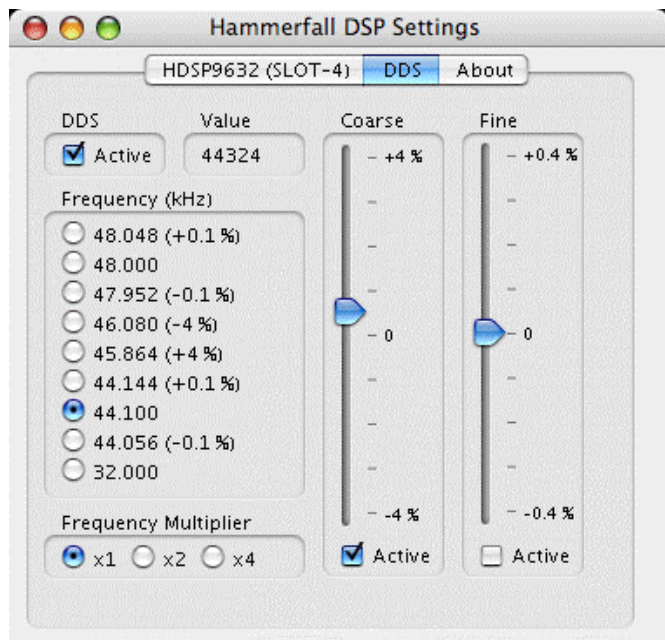

---

### Application examples

DDS allows for a simultaneous change of speed and tune during record and playback. From alignment to other sources up to creative effects – everything is possible..

DDS allows to intentionally de-tune the complete DAW. This way, the DAW can match instruments which have a wrong or unchangeable tuning.

DDS allows to define a specific sample rate. This feature can be is useful in case the system randomly changes the sample rate – for unknown reasons. It also prevents a change from Double Speed (96 kHz) to Single Speed (48 kHz), which would cause configuration and routing problems by the changed amount of ADAT channels.

## 20.3 Clock Modes - Synchronisation

In the digital world, all devices are either the 'Master' (clock source) or a 'Slave' synchronized to the master. Whenever several devices are linked within a system, there must always be a single master clock. The Hammerfall DSP's intelligent clock control is very user-friendly, being able to switch between clock modes automatically. Selecting **AutoSync** will activate this mode.

In AutoSync mode, the system constantly scans all digital inputs for a valid signal. If this signal corresponds with the current playback sample rate, the card switches from the internal quartz (AutoSync Ref displays 'Master') to a clock generated from the input signal (AutoSync Ref displays 'Slave'). This allows on-the-fly recording, even during playback, without having to synchronize the card to the input signal first. It also allows immediate playback at any sample rate without having to reconfigure the card.

AutoSync guarantees that normal record and record-while-play will always work correctly. In certain cases however, e.g. when the inputs and outputs of a DAT machine are connected directly to the Hammerfall DSP, AutoSync may cause feedback in the digital carrier, so synchronization breaks down. To remedy this, switch the HDSP's clock mode over to 'Master'.



*Remember that a digital system can only have one master! If the HDSP's clock mode is set to 'Master', all other devices must be set to 'Slave'.*

The Hammerfall DSP's ADAT optical input and the SPDIF input operate simultaneously. Because there is no input selector however, the HDSP has to be told which of the signals is the sync reference (a digital device can only be clocked from a *single* source). This is why the system has been equipped with automatic clock source selection, which adopts the first available input with a valid digital signal as the clock reference input. The input currently used as sync reference is shown in the *AutoSync Ref* status field, together with its sample frequency.

Via *Pref. Sync Ref* (preferred synchronization reference) a preferred input can be defined. As long as the card sees a valid signal there, this input will be designated as the sync source, otherwise the other inputs will be scanned in turn. If none of the inputs are receiving a valid signal, the card automatically switches clock mode to 'Master'.

To cope with some situations which may arise in studio practice, setting 'Pref Sync Ref' is essential. One example: An ADAT recorder is connected to the ADAT input (ADAT immediately becomes the sync source) and a CD player is connected to the SPDIF input. Try recording a few samples from the CD and you will be disappointed. Few CD players can be synchronized. The samples will inevitably be corrupted, because the signal from the CD player is read with the (wrong) clock from the ADAT i.e. out of sync. In this case, 'Pref Sync Ref' should be temporarily set to SPDIF.

If several digital devices are to be used simultaneously in a system, they not only have to operate with the same sample frequency but also be synchronous with each other. This is why digital systems always need a single device defined as 'master', which sends the same clock signal to all the other ('slave') devices. RME's exclusive **SyncCheck** technology (first implemented in the Hammerfall) enables an easy to use check and display of the current clock status. The 'SyncCheck' field indicates whether no signal ('No Lock'), a valid signal ('Lock') or a valid *and* synchronous signal ('Sync') is present at each of the digital clock source inputs. The *AutoSync Reference* display shows the current sync source and the measured frequency.

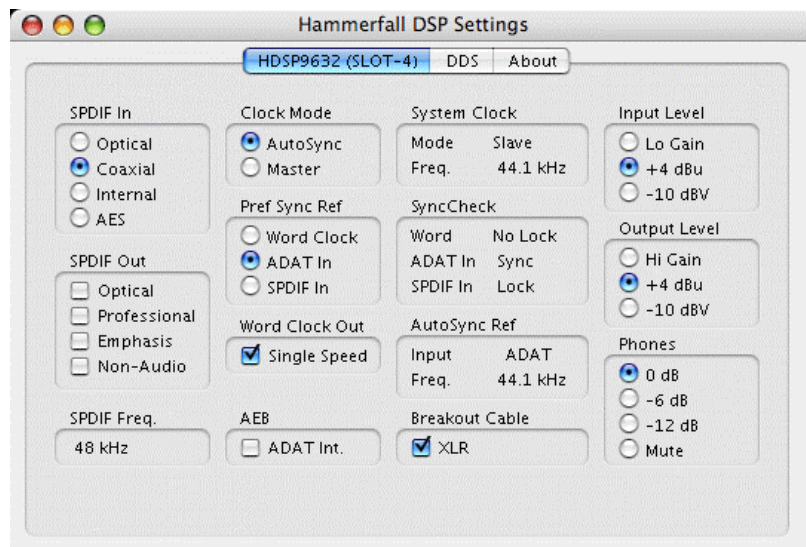

In practice, SyncCheck provides the user with an easy way of checking whether all digital devices connected to the system are properly configured. With SyncCheck, finally anyone can master this common source of error, previously one of the most complex issues in the digital studio world.

Thanks to its AutoSync technique and lightning fast PLLs, the HDSP 9632 is not only capable of handling standard frequencies, but also any sample rate between 28 and 200 kHz. Even the word clock input, which most users will use in varispeed operation, allows any frequency between 28 kHz and 200 kHz.

At 88.2 or 96 kHz: If one of the ADAT inputs has been selected in 'Pref Sync Ref', the sample frequency shown in the field *SPDIF Freq.* differs from the one shown in 'AutoSync Ref'. The card automatically switches to S/MUX mode here, because ADAT optical inputs and outputs are only specified up to 48 kHz. Data from/to a single input/output is spread over two channels, the internal frequency stays at 44.1 or 48 kHz. In such cases, the ADAT sample frequency is only half the SPDIF frequency.

---

## 21. Mac OS X FAQ

### 21.1 Round about Driver Installation

The driver with the file suffix **gz** provided by RME is a compressed **TAR** archive. TAR bundles multiple files and folders into one file, but does not save memory space nor download time. Both TAR and gz are supported natively by OS X, a double click on the file is all you need to do.

Older browsers do not recognize **gz** as an archive, loading the file as a document. This results in a cryptic looking text within the browser window. Downloading the file can be done via the right mouse key, **Save Target as**. Despite this procedure, some older browsers like Netscape 4.78 will not save the file correctly - the archive will be corrupted.

The driver consists of a package file (pkg), which contains various folders and files, similar to TAR. A double click will start the OS X installer. To save you the hassle of installing both audio and MIDI drivers separately, the HDSP driver contains an additional **meta package** (mpkg), that points to the single packages. Those single packages are not shown in the Finder, as they reside within the invisible folder `'.contained_packages'`. Only the mpkg is visible. Important: an installation can only be done with the **complete** folder. If only the mpkg is copied to a different place, it will not find the single driver packages!

The actual audio driver appears as a kernel extension file. The installer copies it to **>System/Library/Extensions<**. Its name is **HammerfallDSP.kext**. It is visible in the Finder, allowing you to verify date and driver version. Yet, in fact this again is a folder containing subdirectories and files.

Nonetheless, this 'driver file' can be removed by simply dragging it to the trash bin. This can be helpful in case a driver installation fails. An incomplete installation can currently (10.3.2) only be detected indirectly: The installation routine does not open a message window with a note about a restart of the computer. This indicates that the driver file was not copied and the driver was not installed!

Several users have observed that the installation routine occasionally stops and no longer works correctly. This can be fixed by removing the corresponding extension file prior to installation. In some cases, also (or only) a repair of the **disk permission** will help.

We have also received reports saying the driver update could not be installed on the system disk - shown red crossed during the installation. Repairing permission may also help here. If not, we're sorry, but have to recommend to contact Apple. Our driver has no knowledge of folders, disks etc., the installation is handled completely by the OS X installer.

### 21.2 MIDI doesn't work

In some cases MIDI does not work after the installation of the HDSP driver. To be precise, applications do not show an installed MIDI port. The reason for this is usually visible within the **Audio MIDI Setup**. It displays no RME MIDI device, or the device is greyed out and therefore inactive. Mostly, removing the greyed out device and searching for MIDI devices again will solve the problem. If this does not help, we recommend manual removal of the MIDI driver and reinstallation of the complete driver. Otherwise repairing permissions may help.

The HDSP MIDI driver is a plugin. During installation it will be copied to **>Library/Audio/MIDI Drivers<**. Its name is **Hammerfall DSP MIDI.plugin**. The file can be displayed in the Finder and also be removed by simply dragging it to the trash bin.



---

## 21.3 Supported Sample Rates

RME's Mac OS X driver supports all sampling frequencies provided by the hardware. Besides **192 kHz** and **96 kHz** this also includes **32 kHz** and **64 kHz**.

But not every software will support all the hardware's sample rates. For example Spark does not display 32 kHz and 64 kHz. The hardware's capabilities can easily be verified in the **Audio MIDI Setup**. Select **Audio devices** under **Properties of:** and choose the Hammerfall DSP. A click on **Format** will list the supported sample frequencies.

If the unit is in clock mode **Master**, selecting a sample rate will immediately set the device to this frequency, which can be verified in the HDSP's settings dialog (System Clock). **Format** thus allows you to activate any sampling frequency quickly and easily.

## 21.4 Repairing Disk Permissions

Repairing permission can solve problems with the installation process - plus many others. To do this, launch **Disk Utility** located in **Utilities**. Select your system drive in the drive/volume list to the left. The **First Aid** tab to the right now allows you to check and repair disk permissions.

## 21.5 PCI card and PCI slot compatibility

Unfortunately not every RME card will work in every PCI slot of an Apple computer. To our knowledge, the current Hammerfall DSP systems can be used in any PCI slot of all G4 and G5 models. In case additional PCI cards of any manufacturer are used, it might happen that the RME card is no longer found by the system. Swapping cards between slots can be helpful in this case.

## 21.6 Various Information

The driver requires 10.2.8 or higher. Older versions of OS X are not and will not be supported.

Via **>System Preferences/ Audio-MIDI Setup<** the hardware can be configured for the system wide usage. Programs that don't support card or channel selection will use the device selected as **Standard-Input** and **Standard-Output**. (Soundstudio, Mplayer, Amplitude etc.).

In the lower part of the window, the audio hardware's capabilities are shown and can be changed in some cases. On the record side no changes are possible. Programs that don't support channel selection will always use channels 1/2, the first stereo pair. To access other inputs use the following workaround with TotalMix: route the desired input signal to output channels 1/2. Hold the Ctrl key down and click on the labels AN1 and AN2 in the third row. Their labels turn red, the internal loop mode is active. Result: the desired input signal is now available at input channel 1/2, without further delay/latency.

Since OS X 10.3 playback can be configured freely and to any of the available playback channels. This is done via **Speaker Setup**. Even multichannel playback (Surround, DVD Player) can be set up easily.

---

### **Multicard Operation**

OS X supports more than one audio device. Since 10.4 (Tiger) Core Audio offers the function **Aggregate Devices**, which allows to combine several devices into one, so that a multi-device operation is possible with any software.

The Hammerfall DSP driver adds a number to each unit, so they are fully accessible in any multicard-capable software.

## **22. Hotline – Troubleshooting**

The newest information can always be found on our website [www.rme-audio.com](http://www.rme-audio.com), section Support, Macintosh OS.

*The 8 ADAT channels don't seem to work*

- The optical output has been switched to *SPDIF*. The ADAT playback devices are still usable by routing and mixing them in TotalMix to other outputs.

*Playback works, but record doesn't:*

- Check that there is a valid signal at the input.
- Check whether the Hammerfall DSP has been selected as recording device in the audio application.

*Crackle during record or playback:*

- Increase the number and size of buffers in the application.
- Try different cables to rule out any defects here.

*The card and drivers have been installed correctly, but playback does not work:*

- Is Hammerfall DSP listed in the System Profiler/PCI? (Vendor 10EE, Device ID 3FC5).
- Has Hammerfall DSP been selected as current playback device in the audio application?

### 23. Diagram: Channel Routing at 96 kHz

This diagram shows the signal paths in double speed mode (88.2 / 96 kHz). The last four channels of the ADAT port have no function anymore in Core Audio, but are used by the hardware to transmit data at double sample rate.

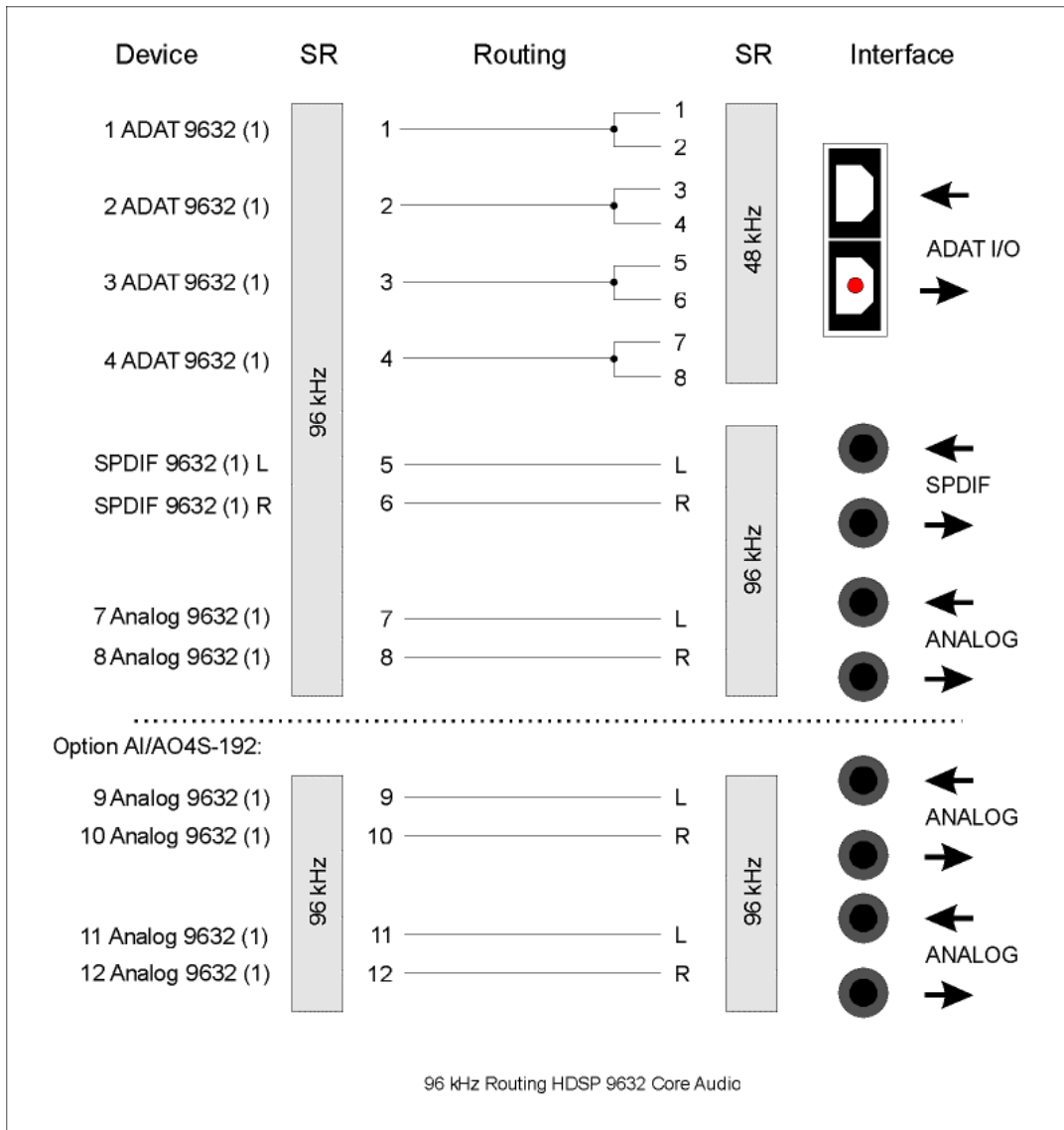



---

## User's Guide



# HDSP 9632

### ▶ Connections and TotalMix

---

## 24. Analog Connections

### 24.1 Line Inputs

The HDSP 9632 has an unbalanced stereo Line input via RCA connectors. The optional analog XLR breakout cable turns the inputs into fully balanced ones.

The electronic input stage is built in a servo balanced design which handles unbalanced and balanced signals correctly, automatically adjusting the level reference.



*When using unbalanced cables with the XLR breakout cable: be sure to connect the 'ring' contact of a stereo TRS jack, and pin 3 of a XLR jack, to ground. Otherwise noise may occur, caused by the unconnected negative input of the balanced input.*

One of the main issues when working with an AD-converter is to maintain the full dynamic range within the best operating level. Therefore the HDSP 9632 internally uses hi-quality electronic switches, which allow for a perfect adaptation of all inputs to the three most often used studio levels.

The 'standardized' studio levels do not result in a (often desired) full scale level, but take some additional digital headroom into consideration. The amount of headroom is different in different standards, and again differently implemented by different manufacturers. Because of this we decided to define the levels of the HDSP 9632 in the most compatible way.

<b>Reference</b>	<b>0 dBFS @</b>	<b>Headroom</b>
Lo Gain	+19 dBu	15 dB
+4 dBu	+13 dBu	9 dB
-10 dBV	+2 dBV	12 dB

With +4 dBu selected, the according headroom meets the latest EBU recommendations for Broadcast usage. At -10 dBV a headroom of 12 dB is common practice, each mixing desk operating at -10 dBV is able to send and receive much higher levels. Lo Gain is best suited for professional users who prefer to work balanced and at highest levels. Lo Gain provides 15 dB headroom at +4 dBu nominal level.

The above levels are also found in our ADI-8 series of AD/DA converters, the Multiface, and even in our Mic-Preamps QuadMic and OctaMic. Therefore all RME devices are fully compatible to each other.

---

## 24.2 Line Outputs

The short circuit protected, low impedance line outputs (channels 11/12) are available as unbalanced outputs via phono breakout cable. The optional analog XLR breakout cable provides XLR connectors and fully balanced operation.

 *The electronic output stage does not operate servo balanced! When connecting unbalanced equipment, make sure pin 3 of the XLR output is not connected. A connection to ground will cause a decreased THD (higher distortion)!*

To maintain an optimum level for devices connected to the analog outputs, the HDSP 9632 internally uses hi-quality electronic switches, which allow for a perfect adaptation of all outputs to the three most often used studio levels.

As with the analog inputs, the analog output levels are defined to maintain a problem-free operation with most other devices. The headroom of the HDSP 9632 lies between 9 and 15 dB, according to the chosen reference level:

Reference	0 dBFS @	Headroom
Hi Gain	+19 dBu	15 dB
+4 dBu	+13 dBu	9 dB
-10 dBV	+2 dBV	12 dB

With +4 dBu selected, the according headroom meets the latest EBU recommendations for Broadcast usage. At -10 dBV a headroom of 12 dB is common practice, each mixing desk operating at -10 dBV is able to send and receive much higher levels. Hi Gain is best suited for professional users who prefer to work balanced and at highest levels. Hi Gain provides 15 dB headroom at +4 dBu nominal level.

 *When using the analog XLR breakout cable, make sure 'Breakout Cable / XLR' is selected in the Settings dialog. Else the analog output level will be 6 dB too high!*

Note that not checking XLR with balanced cables will cause an output level of +25 dBu @ 0 dBFS. Reducing the output level by 1 dB within TotalMix then makes the HDSP 9632's analog outputs compatible to SMPTE (+24 dBu, 15dB headroom).

## 24.3 Headphones

Channels 11/12 of the HDSP 9632 are also available via an 1/4" TRS jack (stereo output). This output is optimized for headphone operation. A speaker protection circuit prevents noise on power up and power down of the computer. The output delivers the same signal as the Line outputs, and its volume is adjusted in the same way via TotalMix. Additionally, the Settings dialog provides level adjustment 0 dB, -6 dB, -12 dB and Mute, independent of the Line output. Thus the level balance between headphones and monitors is easily optimized. When used as high-quality but unbalanced Line output, these options realize a level adjustment similar to the +4/-10 choices of the Line I/Os.

In case the headphone output should operate as Line output, an adapter TRS plug to RCA phono plugs, or TRS plug to TS plugs is required.

The pin assignment follows international standards. The left channel is connected to the tip, the right channel to the ring of the TRS jack/plug.

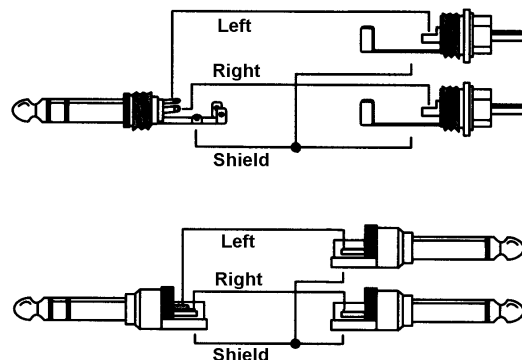

---

## 25. Digital Connections

### 25.1 ADAT

The ADAT optical I/O of the HDSP 9632 is fully compatible to all ADAT equipped units. RME's unsurpassed Bitclock PLL prevents clicks and drop outs even in extreme varipitch operation, and guarantees a fast and low jitter lock to the digital input signal. A usual TOSLINK cable is sufficient for connection. More information on Double Speed (S/MUX) can be found in chapter 33.3.

#### ADAT In

Interface for a device sending an ADAT signal to the HDSP 9632. Carries the channels 1 to 8. When receiving a Double Speed signal, this input carries the channels 1 to 4. Can also be used as SPDIF optical input.

#### ADAT Out

Interface for a device receiving an ADAT signal from the HDSP 9632. Transmits channels 1 to 8. When sending a Double Speed signal, this port carries channels 1 to 4. Can also be used as SPDIF optical output.

### 25.2 SPDIF

#### Input

The SPDIF input is configured in the Settings dialog, available by a click on the hammer symbol in the Task Bar's system tray. The HDSP system accepts all commonly used digital sources as well as SPDIF and AES/EBU. Channel status and copy protection are ignored.

In case the optional digital XLR breakout cable is not used, receiving signals in AES/EBU format requires a cable adapter. Pins 2 and 3 of a female XLR plug are connected individually to the two pins of a phono plug. The cable shielding is only connected to pin 1 of the XLR - not to the phono plug.

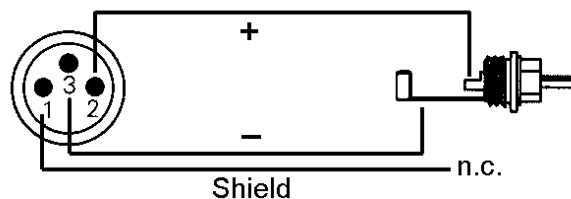

The ground-free design, with transformers for coaxial digital inputs and outputs, offers a trouble-free connection of all devices along with perfect hum rejection and full AES/EBU compatibility.

#### Output

In SPDIF mode, identical signals are available at both the optical and the coaxial output. An obvious use for this would be to connect two devices, i.e. using the HDSP as a splitter (distribution 1 on 2).

Apart from the audio data itself, digital signals in SPDIF or AES/EBU format have a header containing channel status information. False channel status is a common cause of malfunction. The HDSP system ignores the received header and creates a totally new one for its output signal.

 *Note that in record or monitor modes, set Emphasis bits will disappear. Recordings originally done with Emphasis should always be played back with the Emphasis bit set!*

This is done by selecting *Emphasis* in the *SPDIF Out* section of the Settings dialog. This setting is updated immediately, even during playback.



---

Note: Recordings with (pre-) emphasis show a treble boost (50/15  $\mu$ s), which has to be compensated at playback. Therefore, when selecting *Emphasis* all analog outputs will be processed by a treble filter based on 50/15 $\mu$ s, which sounds like a high cut.

The HDSP 9632's new output header is optimized for largest compatibility with other digital devices:

- 32 kHz, 44.1 kHz, 48 kHz, 88.2 kHz, 96 kHz, 176.4 kHz, 192 kHz depending on the current sample rate
- Audio use, Non-Audio
- No Copyright, Copy Permitted
- Format Consumer or Professional
- Category General, Generation not indicated
- 2-channel, No Emphasis or 50/15  $\mu$ s
- Aux bits Audio Use

For AES/EBU output operation the optional digital XLR breakout cable is required, as the phono output has too low voltage for a reliable operation in AES format.



*Note that most consumer HiFi equipment (with optical or phono SPDIF inputs) will only accept signals in 'Consumer' format!*

The audio bit in the header can be set to 'Non-Audio'. This is often necessary when Dolby AC-3 encoded data is sent to external decoders (surround-sound receivers, television sets etc. with AC-3 digital inputs), as these decoders would otherwise not recognize the data as AC-3.

### **25.3 MIDI**

The HDSP 9632 offers one MIDI I/O via two 5-pin DIN connectors. The MIDI ports are added to the system by the driver. Using MIDI capable software, these ports can be accessed under the name *HDSP MIDI*. Using more than one HDSP 9632, the operating system adds a consecutive number to the port name, like *HDSP MIDI In (2)* etc.

The MIDI In port is available for both GSIF (GSIF-2 Low Latency) and standard MME MIDI simultaneously.

---

## 26. Word Clock

### 26.1 Word Clock Input and Output (optional Word Clock Module)

*SteadyClock* guarantees an excellent performance in all clock modes. Based on the highly efficient jitter suppression, the HDSP 9632 refreshes and cleans up any clock signal, and provides it as reference clock at the BNC output (see section 33.7).

#### Input

The HDSP 9632's transformer isolated word clock input is active when *Pref. Sync Ref* in the Settings dialog has been switched to *Word Clock*, the clock mode *AutoSync* has been activated, and a valid word clock signal is present. The signal at the BNC input can be Single, Double or Quad Speed, the HDSP 9632 automatically adapts to it. As soon as a valid signal is detected, the green LED is lit, and the Settings dialog shows either Lock or Sync (see chapter 33.1).

Thanks to RME's *Signal Adaptation Circuit*, the word clock input still works correctly even with heavily mis-shaped, dc-prone, too small or overshoot-prone signals. Thanks to automatic signal centering, 300 mV (0.3V) input level are sufficient in principle. An additional hysteresis reduces sensitivity to 1.0 V, so that over- and undershoots and high frequency disturbances don't cause a wrong trigger.

The word clock input is shipped as high impedance type (not terminated). A push switch allows to activate internal termination (75 Ohms). The switch is found beside the word clock input socket. Use a small pencil or similar and carefully push the blue switch so that it snaps into its lock position. The yellow LED will be lit when termination is active. Another push will release it again and de-activate the termination.

#### Output

The word clock output of the HDSP 9632 is constantly active, providing the current sample frequency as word clock signal. As a result, in Master mode the provided word clock is defined by the currently used software. In Slave mode the provided frequency is identical to the one present at the currently chosen clock input. When the current clock signal fails, the HDSP 9632 switches to Master mode and adjusts itself to the next, best matching frequency (44.1 kHz, 48 kHz etc.).

Selecting *Single Speed* in the Settings dialog (Word Clock Out) causes the output signal to always stay within the range of 32 kHz to 48 kHz. So at 96 kHz and 192 kHz sample rate, the output word clock is 48 kHz.

The received word clock signal can be distributed to other devices by using the word clock output. With this the usual T-adaptor can be avoided, and the HDSP 9632 operates as *Signal Refresher*. This kind of operation is highly recommended, because

- input and output are phase-locked and in phase (0°) to each other
- *SteadyClock* removes nearly all jitter from the input signal
- the exceptional input (1 Vpp sensitivity instead of the usual 2.5 Vpp, dc cut, *Signal Adaptation Circuit*) plus *SteadyClock* guarantee a secure function even with highly critical word clock signals
- the Word Clock Module provides two word clock outputs with separated driver stages

Thanks to a low impedance, but short circuit proof output, the HDSP 9632 delivers 4 Vpp to 75 Ohms. For wrong termination with 2 x 75 Ohms (37.5 Ohms), there are still 3.3 Vpp fed into the network – per output!

---

## 26.2 Technical Description and Usage

In the analog domain one can connect any device to another device, a synchronization is not necessary. Digital audio is different. It uses a clock, the sample frequency. The signal can only be processed and transmitted when all participating devices share the same clock. If not, the signal will suffer from wrong samples, distortion, crackle sounds and drop outs.

AES/EBU, SPDIF and ADAT are self-clocking, an additional word clock connection in principle isn't necessary. But when using more than one device simultaneously problems are likely to happen. For example any self-clocking will not work in a loop cabling, when there is no 'master' (main clock) inside the loop. Additionally the clock of all participating devices has to be synchronous. This is often impossible with devices limited to playback, for example CD players, as these have no SPDIF input, thus can't use the self clocking technique as clock reference.

In a digital studio synchronisation is maintained by connecting all devices to a central sync source. For example the mixing desk works as master and sends a reference signal, the word clock, to all other devices. Of course this will only work as long as all other devices are equipped with a word clock or sync input, thus being able to work as slave (some professional CD players indeed have a word clock input). Then all devices get the same clock and will work in every possible combination with each other.



*Remember that a digital system can only have one master! If the 9632's clock mode is set to 'Master', all other devices must be set to 'Slave'.*

But word clock is not only the 'great problem solver', it also has some disadvantages. The word clock is based on a fraction of the really needed clock. For example SPDIF: 44.1 kHz word clock (a simple square wave signal) has to be multiplied by 256 inside the device using a special PLL (to about 11.2 MHz). This signal then replaces the one from the quartz crystal. Big disadvantage: because of the high multiplication factor the reconstructed clock will have great deviations called jitter. The jitter of a word clock is typically 15 times higher as when using a quartz based clock.

The end of these problems should have been the so called Superclock, which uses 256 times the word clock frequency. This equals the internal quartz frequency, so no PLL for multiplying is needed and the clock can be used directly. But reality was different, the Superclock proved to be much more critical than word clock. A square wave signal of 11 MHz distributed to several devices - this simply means to fight with high frequency technology. Reflections, cable quality, capacitive loads - at 44.1 kHz these factors may be ignored, at 11 MHz they are the end of the clock network. Additionally it was found that a PLL not only generates jitter, but also also rejects disturbances. The slow PLL works like a filter for induced and modulated frequencies above several kHz. As the Superclock is used without any filtering such a kind of jitter and noise suppression is missing. No wonder Superclock did not become a commonly accepted standard.

The actual end of these problems is offered by the **SteadyClock** technology of the HDSP 9632. Combining the advantages of modern and fastest digital technology with analog filter techniques, re-gaining a low jitter clock signal of 22 MHz from a slow word clock of 44.1 kHz is no problem anymore. Additionally, jitter on the input signal is highly rejected, so that even in real world usage the re-gained clock signal is of highest quality.

---

## 26.3 Cabling and Termination

Word clock signals are usually distributed in the form of a network, split with BNC T-adapters and terminated with resistors. We recommend using off-the-shelf BNC cables to connect all devices, as this type of cable is used for most computer networks. You will find all the necessary components (T-adapters, terminators, cables) in most electronics and/or computer stores.

Ideally, the word clock signal is a 5 Volt square wave with the frequency of the sample rate, of which the harmonics go up to far above 500 kHz. To avoid voltage loss and reflections, both the cable itself and the terminating resistor at the end of the chain should have an impedance of 75 Ohm. If the voltage is too low, synchronization will fail. High frequency reflection effects can cause both jitter and sync failure.

Unfortunately there are still many devices on the market, even newer digital mixing consoles, which are supplied with a word clock output that can only be called unsatisfactory. If the output breaks down to 3 Volts when terminating with 75 Ohms, you have to take into account that a device, of which the input only works from 2.8 Volts and above, does not function correctly already after 3 meter cable length. So it is not astonishing that because of the higher voltage, word clock networks are in some cases more stable and reliable if cables are not terminated at all.

Ideally all outputs of word clock delivering devices are designed with very low impedance, but all word clock inputs with high impedance, in order to not weaken the signal on the chain. But there are also negative examples, when the 75 Ohms are built into the device and cannot be switched off. In this case the network load is often 2 x 75 Ohms, and the user is forced to buy a special word clock distributor. Note that such a device is generally recommended for bigger studios.

The HDSP 9632's word clock input can be high-impedance or terminated internally, ensuring maximum flexibility. If termination is necessary (e.g. because the card is the last device in the chain), push the switch at the back beside the BNC socket (see chapter 26.1).

In case the HDSP 9632 resides within a chain of devices receiving word clock, plug a T-adapter into its BNC input jack, and the cable supplying the word clock signal to one end of the adapter. Connect the free end to the next device in the chain via a further BNC cable. The last device in the chain should be terminated using another T-adapter and a 75 Ohm resistor (available as short BNC plug). Of course devices with internal termination do not need T-adaptor and terminator plug.



*Due to the outstanding SteadyClock technology of the HDSP 9632, we recommend not to pass the input signal via T-adapter, but to use the card's word clock output instead. Thanks to SteadyClock, the input signal will both be freed from jitter and - in case of loss or drop out - be reset to a valid frequency.*

## 26.4 Operation

The HDSP 9632's word clock input is active when *Pref. Sync Ref* in the Settings dialog has been set to *Word Clock*, the clock mode *AutoSync* has been activated, and a valid word clock signal is present. The signal at the BNC input can be Single, Double or Quad Speed, the HDSP automatically adapts to it. As soon as a valid signal is detected, the green LED at the bracket is lit, and the Settings dialog shows either Lock or Sync (see chapter 33.1). In the status display *AutoSync Ref* the display changes to *Word*. This message has the same function as the green Lock LED, but appears on the monitor, i.e. the user can check immediately whether a valid word clock signal is present and is currently being used.

In the line *Freq.*, the *AutoSync Ref* shows the frequency of the reference signal, measured by the hardware. In this case the frequency of the current wordclock signal is measured and displayed.

---

## 27. TotalMix: Routing and Monitoring

### 27.1 Overview

The HDSP 9632 includes a powerful digital real-time mixer, the *Hammerfall DSP mixer*, based on RME's unique, sample-rate independent **TotalMix** technology. It allows for practically unlimited mixing and routing operations, with all inputs and playback channels simultaneously, to any hardware outputs.

Here are some typical applications for TotalMix:

- Setting up delay-free submixes (headphone mixes). The HDSP 9632 allows for up to 8 (!) fully independent stereo submixes. On an analog mixing desk, this would equal 16 (!) Aux sends.
- Unlimited routing of inputs and outputs (free utilisation, patchbay functionality).
- Distributing signals to several outputs at a time. TotalMix offers state-of-the-art splitter and distributor functions.
- Simultaneous playback of different programs using only one stereo output. The ASIO multi-client driver allows to use several programs at the same time, but only on different playback channels. TotalMix provides the means to mix and monitor these on a single stereo output.
- Mixing of the input signal to the playback signal (complete ASIO Direct Monitoring). RME not only is *the* pioneer of ADM, but also offers the most complete implementation of the ADM functions.
- Integration of external devices. Use TotalMix to insert external effects devices, be it in the playback or in the record path. Depending on the current application, the functionality equals insert or effects send and effects return, for example as used during real-time monitoring when adding some reverb to the vocals.

Every single input channel, playback channel and hardware output features a Peak and RMS level meter, calculated in hardware (hardware output is Peak only). These level displays are very useful to determine the presence and routing destinations of the audio signals.

For a better understanding of the TotalMix mixer you should know the following:

- As shown in the block diagram (next page), the record signal usually stays un-altered. TotalMix does not reside within the record path, and does not change the record level or the audio data to be recorded (exception: loopback mode).
- The hardware input signal can be passed on as often as desired, even with different levels. This is a big difference to conventional mixing desks, where the channel fader always controls the level for all routing destinations simultaneously.
- The level meter of inputs and playback channels are connected pre-fader, to be able to visually monitor where a signal is currently present. The level meters of the hardware's outputs are connected post-fader, thus displaying the actual output level.

RME TotalMix  
 Hammerfall DSP Mixer  
 HDSP 9632  
 Block Diagram, 07/2005

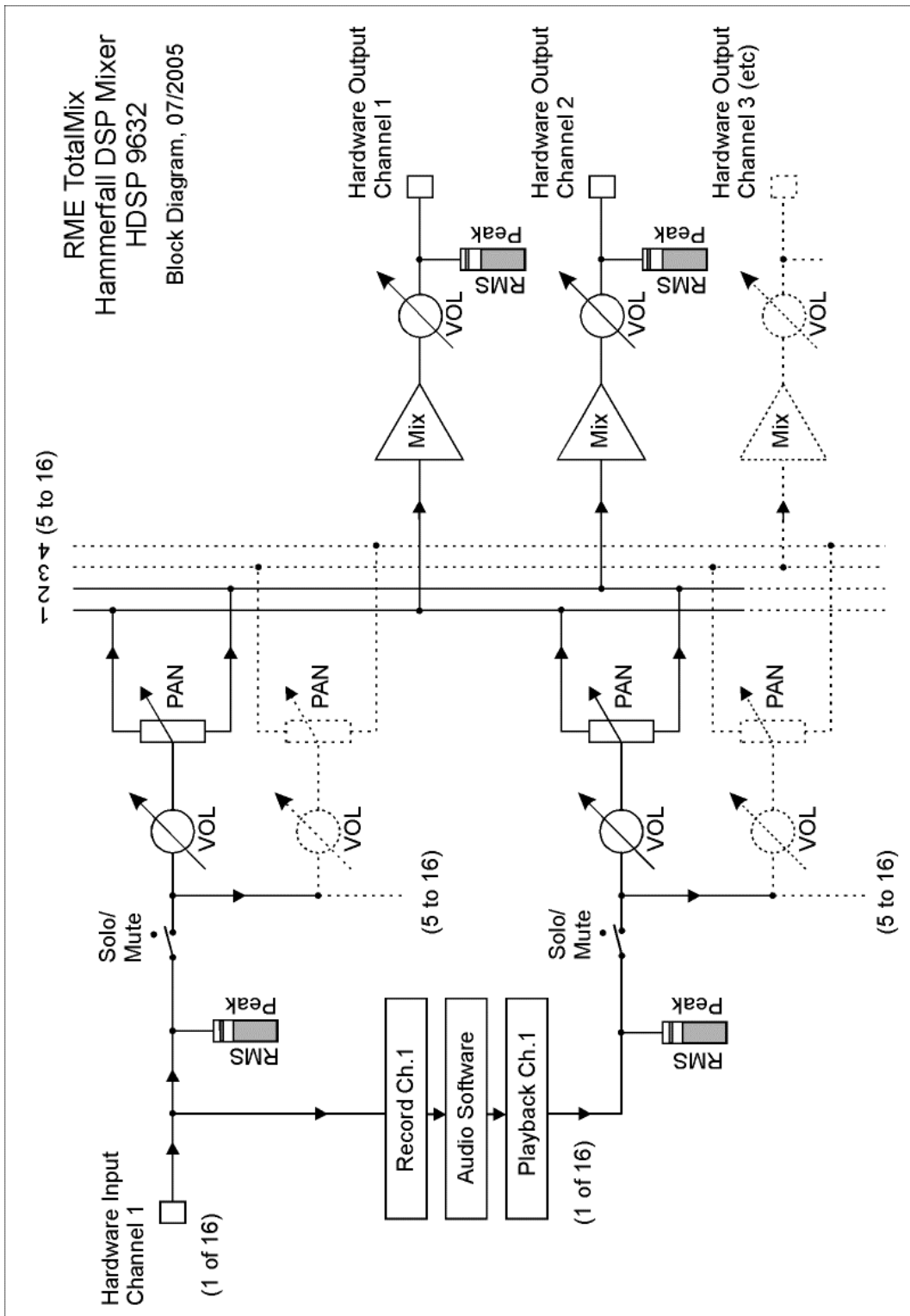

---

## 27.2 The User Interface

The visual design of the TotalMix mixer is a result of its capability to route hardware inputs and software playback channels to any hardware output. The HDSP 9632 provides up to 16 input channels, 16 software playback channels, and 16 hardware output channels:

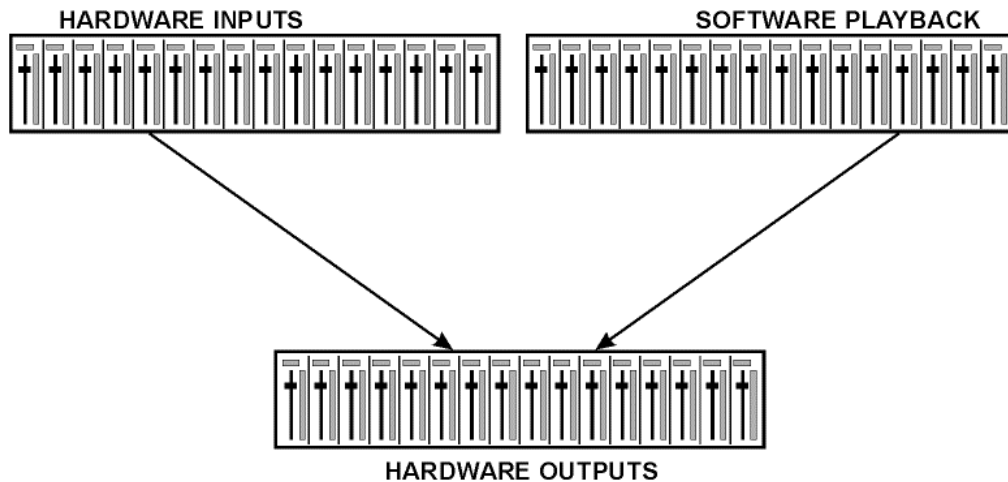

32 channels don't fit on the screen side by side, neither does such an arrangement provide a useful overview. The input channel should be placed above the corresponding output channel. Therefore, the channels have been arranged as known from an *Inline* desk, so that the row *Software Playback* equals the *Tape Return* of a real mixing desk:

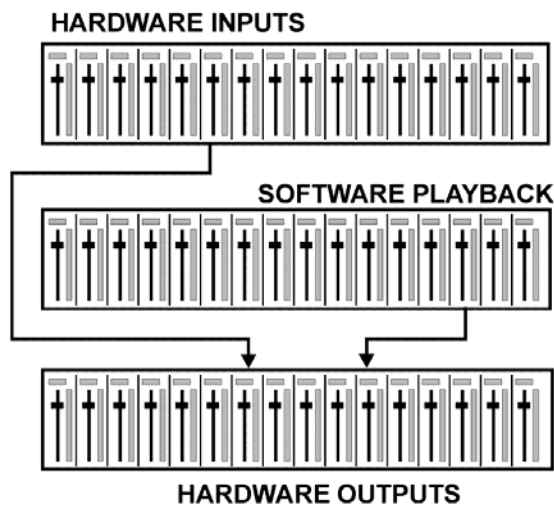

- Top row: Hardware inputs. The level shown is that of the input signal, i. e. fader independent. Via fader and routing field, any input channel can be routed and mixed to any hardware output (bottom row).
- Middle row: Playback channels (playback tracks of the audio software). Via fader and routing field, any playback channel can be routed and mixed to any hardware output (third row).
- Bottom row (third row): Hardware outputs. Here, the total level of the output can be adjusted. This may be the level of connected loudspeakers, or the necessity to reduce the level of an overloaded submix.

The following chapters explain step by step all functions of the user interface.

---

## 27.3 Elements of a Channel

A single channel consists of various elements:

Input channels and playback channels each have a mute and solo button.

Below there is the panpot, realized as indicator bar (L/R) in order to save space.

In the field below, the present level is displayed in RMS or Peak, being updated about every half a second. Overs (overload) are indicated here by an additional red dot.

Next is the fader with a level meter. The meter shows both peak values (zero attack, 1 sample is enough for a full scale display) by means of a yellow line, and mathematically correct RMS values by means of a green bar. The RMS display has a relatively slow time constant, so that it shows the average loudness quite well.

Below the fader, the current gain and panorama values are shown.

The white area shows the channel name. Selecting one or more channels is done by clicking on the white label which turns orange then. A click in the third row with pressed Ctrl-key activates internal loopback mode, the label turns red. A right mouse click opens a dialog to type in a new name.

The black area (routing field) shows the current routing target. A mouse click opens the routing window to select a routing target. The list shows all currently activated routings by checkmarks in front of the routing targets.



## 27.4 Tour de TotalMix

This chapter is a practical guide and introduction on how to use TotalMix, and on how TotalMix works.

Starting up TotalMix the last settings are recalled automatically. When executing the application for the first time, a default file is loaded, sending all playback tracks 1:1 to the corresponding hardware outputs with 0 dB gain, and activating phones monitoring.

Hold down Ctrl and click on preset button 1 to make sure that factory preset 1 is loaded. The faders in the top row are set to maximum attenuation (called m.a. in the following), so there is no monitoring of the input channels. The **Submix View** is active, therefore for improved overview all outputs except AN1/AN2 are greyed out. Additionally all faders are set to the routing target AN 1+2. All faders of the middle row are set to 0 dB, so no matter on which channels a playback happens, the audio will be audible via the Phones output. Just try it!

We will now create a submix on the analog outputs. Please start a multitrack playback. In the third row, click on the channels of hardware output AN1 or AN2. The Submix View changes to AN1/AN2. Both the fader settings and the output levels of all other channels are still visible, but greyed out for improved orientation.

As soon as AN1/AN2 became active, all faders of the second row jumped to their bottom position – except those of playback channel 11/12. This is correct, because as mentioned above the factory preset includes a 1:1 routing. Click on A 3/4 and the faders above are the only active ones, same for A 5/6 and so on.

Back to AN1/2. Now you can change all the faders of all inputs and playback channels just as you like, thus making any input and playback signals audible via the analog outputs. The panorama can be changed too. Click into the area above the fader and drag the green bar in order to set the panorama between left and right. The level meters of the third row display the level changes in real-time.



As shown it is very easy to set up a specific submix for whatever output: select output channel, set up fader and pans of inputs and playbacks – ready!

For advanced users sometimes it makes sense to work without Submix View. Example: you want to see and set up some channels of different submixes simultaneously, without the need to change between them all the time. Switch off the Submix View by a click on the green button. Now the black routing fields below the faders no longer show the same entry (AN 1+2), but completely different ones. The fader and pan position is the one of the individually shown routing destination.

In playback channel 1 (middle row), labeled Out 1, click onto the routing field below the label. A list pops up, showing a checkmark in front of 'A 1+2' and 'AN 1+2'. So currently playback channel 1 is sent to these two routing destinations. Click onto 'A 7+8'. The list disappears, the routing field no longer shows 'AN1+2', but 'A 7+8'. Now move the fader with the mouse. As soon as the fader value is unequal m.a., the present state is being stored and routing is activated. Move the fader button to around 0 dB. The present gain value is displayed below the fader in green letters.

In the lower row, on channel 7, you can see the level of what you are hearing from output 7. The level meter of the hardware output shows the outgoing level. Click into the area above the fader and drag the mouse in order to set the panorama, in this case the routing between channels 7 and 8. The present pan value is also being displayed below the fader.

Please carry out the same steps for Out 2 now, in order to route it to output 8 as well.

In short: While editing the Submix A 7+8 you have direct access to other submixes on other channels, because their routing fields are set to different destinations. And you get a direct view of how their faders and panoramas are set up.



*This kind of visual presentation is a mighty one, but for many users it is hard to understand, and it requires a deep understanding of complex routing visualizations. Therefore we usually re-recommend to work in **Submix View**.*

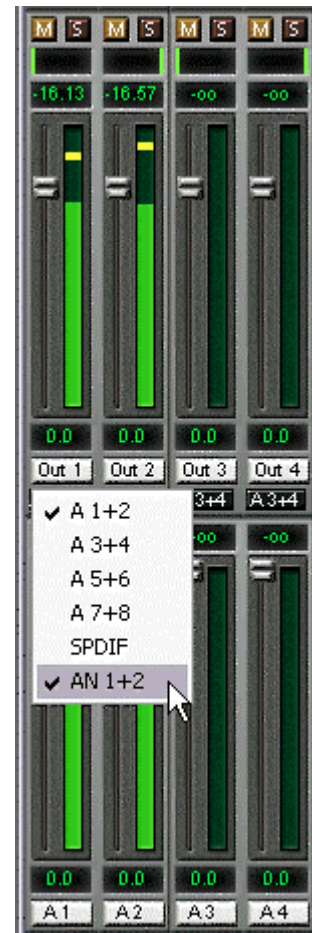

Often signals are stereo, i. e. a pair of two channels. It is therefore helpful to be able to make the routing settings for two channels at once. Hold down the Ctrl-key and click into the routing field of Out 3. The routing list pops up with a checkmark at 'A 3+4'. Select 'A 7+8'. Now, Out 4 has already been set to 'A 7+8' as well.

When you want to set the fader to exactly 0 dB, this can be difficult, depending on the mouse configuration. Move the fader close to the 0 position and now press the Shift-key. This activates the fine mode, which stretches the mouse movements by a factor of 8. In this mode, a gain setting accurate to 0.1 dB is no problem at all.

Please set Out 4 to a gain of around -20 dB and the pan close to center. Now click onto the routing field. You'll now see three checkmarks, at 'A 3+4', 'A 7+8' and 'AN 1+2'. Click onto 'SPDIF'. The window disappears, fader and pan jump to their initial values, the signal can now be routed to the SPDIF output. You can continue like this until all entries have got a checkmark, i. e. you can send the signal to all outputs simultaneously.

---

You will certainly have noticed that the signal at the outputs 7/8 did not change while you were routing channel 4 to other outputs and setting different gain values for those. With all analog and most digital mixing desks, the fader setting would affect the level for every routed bus - not so for TotalMix. TotalMix allows for setting all fader values individually. Therefore the faders and the panpots jump to the appropriate setting as soon as another routing is chosen.

Sometimes you will want the routings not to be independent. Let's say you have sent a signal to several submixes, and now want to change the signal's volume a bit on *all* these submixes. Dragging the faders by use of the right mouse button activates **Post Send** mode and causes all routings of the current input or playback channel to be changed in a relative way. Please note that the fader settings of all routings are memorized. So when pulling the fader to the bottom (maximum attenuation), the individual settings are back when you right click the mouse and pull the fader up. The individual settings get lost in m.a. position as soon as the fader is clicked with the left mouse button. As long as no single level is at m.a. position, the left mouse button can be used to change the current routing's gain.

The checkmarks are un-checked by moving the fader to m.a. This setting deactivates the routing...why route if there is no level? Click onto 'A 7+8' in the routing window, pull the fader down, open the routing window again - the checkmark is gone.

The number of ADAT channels is reduced automatically when entering Double Speed mode (96 kHz). The display is adjusted accordingly, and all fader settings remain stored.

## 27.5 Submix View

Such a wide range of possibilities make it difficult to maintain the overview. Because practically all hardware outputs can be used for different submixes, as shown (up to 8 completely independent stereo submixes, 4 4-channel submixes etc.). And when opening the routing windows you might see an army of checkmarks, but you don't get an overview, i.e., how the signals come together and where. This problem is solved by **Submix View** mode. In this mode, all routing fields jump to the routing pair just being selected. You can then see immediately, which channels, which fader and pan settings make a submix (for example 'AN 1+2'). At the same time the Submix View simplifies setting up the mixer, as all channels can be set simultaneously to the same routing destination with just one click.

Changing to a different destination (output channel) is done in any routing field, or by a click on the desired output pair in the bottom row.

## 27.6 Mute und Solo

Mute operates pre-fader, thus mutes all currently active routings of the channel. As soon as any Mute button is pressed, the *Mute Master* button lights up in the Quick Access area. It allows to switch all selected mutes off and on again. You can comfortably make mute-groups or activate and deactivate several Mutes simultaneously.

The same holds true for the Solo and the *Solo Master* buttons. As with conventional mixing desks, Solo operates only for the output defined as **Monitor Main**, as a solo-in-place, post fader. As soon as one Solo button is pressed, the *Solo Master* button lights up in the Quick Access area. It allows to switch all selected Solos off and on again. You can comfortably make solo-groups or activate and deactivate several Solos simultaneously.

---

## 27.7 The Quick Access Panel

This section includes additional options, further improving the handling of TotalMix. The Master buttons for Mute and Solo have already been described, they allow for group-based working with these functions.

In the **View** section the single mixer rows can be made visible or invisible. If the inputs are not needed for a pristine playback mix, the whole upper row falls out of the picture after a click on the Input button. If the hardware outputs don't interest you either, the window can thus be reduced to the playback channels to save space. All combinations are possible and allowed.

As described earlier, **Submix** sets all routing windows to the same selection. Deactivating Submix automatically recalls the previous view. The mixer can be made smaller horizontally and vertically. This way TotalMix can be made substantially smaller and space-saving on the desktop/screen, if you have to monitor or set only a few channels or level meters.

The **Presets** are one of the most powerful and useful features of TotalMix. Behind the eight buttons, eight files are hidden (see next chapter). These contain the complete mixer state. All faders and other settings follow the changing of preset(s) in real-time, just by a single mouse click. The **Save** button allows for storing the present settings in any preset. You can change back and forth between a signal distribution, complete input monitoring, a stereo and mono mix, and various submixes without any problem.

Also here, RME's love for details can be seen. If any parameter is being altered after loading a preset (e. g. moving a fader), the preset display flashes in order to announce that something has been changed, still showing which state the present mix is based on.

If no preset button is lit, another preset had been loaded via the **File** menu and **Open file**. Mixer settings can of course be saved the usual way, and have long file names.



Instead of single presets a complete bank of (8) presets can be loaded at once. Advantage: The names defined for the preset buttons will be stored and loaded automatically.

Up to three Hammerfall DSP systems can be used simultaneously. The **Unit** buttons switch between the systems (HDSP 9632, Digiface, HDSP 9652 or Multiface). Holding down Ctrl while clicking on button Unit 2 or Unit 3 will open another TotalMix window.

## 27.8 Presets

TotalMix includes eight factory presets, stored within the program. The user presets can be changed at any time, because TotalMix stores and reads the changed presets from the files **preset11.mix** to **preset81.mix**, located in Windows' hidden directory *Documents and Settings*, *<Username>*, *Local Settings*, *Application Data*, *RME TotalMix*. On the Mac the location is in the folder *User*, *<Username>*, *Library / Preferences / Hammerfall DSP*. The first number indicates the current preset, the second number the current unit.

This method offers two major advantages:

- Presets modified by the user will not be overwritten when reinstalling or updating the driver
- The factory presets remain unchanged, and can be reloaded any time.

---

**Mouse:** The original factory presets can be reloaded by holding down the Ctrl-key and clicking on any preset button. Alternatively the files described above can be renamed, moved to a different directory, or being deleted.

**Keyboard:** Using Ctrl and any number between 1 and 8 (not on the numeric keypad!) will load the corresponding factory default preset. The key Alt will load the user presets instead.



When loading a preset file, for example 'Main Monitor AN 1\_2 plus headphone mix 3\_4.mix', the file name will be displayed in the title bar of the TotalMix window. Also when loading a preset by the preset buttons, the name of the preset is displayed in the title bar. This way it is always clear what the current TotalMix state is based on.

The eight factory presets offer a pretty good base to modify them to your personal needs. In all factory presets Submix View is active by default.

### **Preset 1**

Description: All channels routed 1:1, monitoring of all playback channels via analog out.

Details: All inputs maximum attenuation. All playback channels 0 dB, routed to the same output. All outputs 0 dB. Submix of all playbacks to the analog output. Level display set to RMS +3 dB. View Submix active.

Note: This preset is *Default*, offering the standard functionality of a I/O-card.

### **Preset 2**

Description: All channels routed 1:1, input and playback monitoring via analog out. As Preset 1, plus submix of all inputs (0 dB) to the analog output.

### **Preset 3**

Description: All channels routed 1:1, input and playback monitoring via analog outputs. As Preset 2, but all inputs set to 0 dB (1:1 pass through).

### **Preset 4**

Description: All channels 1:1, playback monitoring via analog outputs. As Preset 3, but all inputs muted.

### **Preset 5**

Description: All faders m.a. As Preset 1, but all outputs maximum attenuation, only analog monitor of the playbacks is active.

### **Preset 6**

Description: Submix to SPDIF. As Preset 1, plus submix of all playbacks to SPDIF.

### **Preset 7**

Description: Submix to SPDIF. As Preset 6, plus submix of all inputs to SPDIF.

### **Preset 8**

Description: Panic. As Preset 4, but playback channels muted too (no output signal).

### **Preset Banks**

Instead of a single preset, all eight presets can be stored and loaded at once. This is done via Menu **File, Save All Presets as** and **Open All Presets** (file suffix .mpr). After the loading the presets can be activated by the preset buttons. In case the presets have been renamed (see chapter 27.11), these names will be stored and loaded too.

## 27.9 The Monitor Panel

The Monitor panel provides several options usually found on analog mixing desks. It offers quick access to monitoring functions which are needed all the time in typical studio work.

### Monitor Main

Use the drop down menu to select the hardware outputs where your main monitors are connected to.

### Dim

A click on this button will lower the volume of your main monitor output (see above) by an amount set up in the Preferences dialog (see below). This is the same as moving the third row faders down a bit, but much more convenient, as the old setting is back by a simple mouse click.

### Mono

Sets the stereo output defined above to monaural playback. Useful to check for mono compatibility and phase problems.

### Talkback

A click on this button will dim the Main Monitor output (see above) by an amount set up in the Preferences dialog. At the same time the control room's microphone signal (source defined in Preferences) is sent to the three destinations described below as *Monitor Phones*. The mic level is adjusted with the channel's input fader.



### Monitor Phones 1/2/3

Use the drop down menu to select the hardware outputs where the submixes are sent to. These submixes are usually phones mixdowns for the musicians. A click on the button allows to hear the specific submix via the Main Monitor outputs. So when setting up or modifying the submix for the musician this process can be monitored easily and any time. Or in other words: you can easily check other hardware outputs/submixes by using the Monitor Phones function, without the need to copy/paste routings back and forth, or to reconfigure the cabling at the hardware.

## 27.10 Preferences

The dialog box Preferences is available via the menu *Options* or directly via F3.

### Talkback

Input: Select the input channel of the Talkback signal (microphone in control room).

Dim: Amount of attenuation of the Main Monitor output in dB.

### Listenback

Input: Select the input channel of the Listenback signal (microphone in recording room).

Dim: Amount of attenuation of the Monitor Phones outputs in dB.

Note: The Mute button of the Talkback and Listenback channel is still active. Therefore it is not necessary to select <NONE>, in case one of both shall be deactivated.

### MIDI Controller, Full LC Display Support

See chapter 30.3 for details.

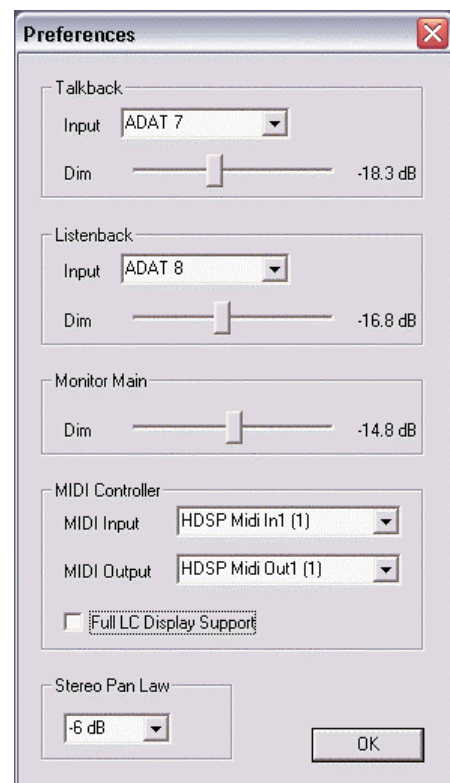

## Main Monitor

Dim: Amount of attenuation of the Main Monitor output in dB. Activated by the *Dim* button in the Monitor panel.

## Stereo Pan Law

The Pan Law can be set to -6 dB, -4.5 dB, -3 dB and 0 dB. The value chosen defines the level attenuation in pan center position. This setting is useful because the ASIO host often supports different pan laws too. Selecting the same value here and in the ASIO host, ASIO Direct Monitoring works perfectly, as both ASIO host and TotalMix use the same pan law. Of course, when not using ADM it can be changed to a setting different from the factory preset of -6 dB as well. You will most probably find that -3 dB gives a much more stable loudness when moving an object between left and right.

## 27.11 Editing the Names

The channel names shown in the white label area can be edited. A right mouse click on the white name field brings up the dialog box **Enter Name**. Any name can be entered in this dialog. Enter/Return closes the dialog box, the white label now shows the first letters of the new name. ESC cancels the process and closes the dialog box.



Moving the mouse above the label brings up a tool tip with the complete name.



The hardware outputs (third row) can be edited in the same way. In this case, the names in the routing drop down menus will change automatically. Additionally the names in the drop down menus of the Monitor section will change as well.

The preset buttons can get meaningful names in the same way. Move the mouse above a preset button, a right mouse click will bring up the dialog box. Note that the name shows up as tool tip only, as soon as the mouse stays above the preset button.



The preset button names are not stored in the preset files, but globally in the registry, so won't change when loading any file or saving any state as preset. But loading a preset bank (see chapter 27.8) the names will be updated.

---

## 27.12 Hotkeys

In many situations TotalMix can be controlled quickly and comfortably by the keyboard, making the mixer setup considerably easier and faster. The **Shift**-key for the fine mode for faders and panpots has already been mentioned. The **Ctrl**-key can do far more than changing the routing pairwise:

- Clicking anywhere into the fader area with the Ctrl-key pressed, sets the fader to 0 dB.
- Clicking anywhere into the pan area with the Ctrl-key pressed, sets the panorama to <C> meaning Center.
- Clicking a preset button while holding down Ctrl, the original factory preset will be loaded.
- Using Ctrl and any number between 1 and 8 (not on the numeric keypad!) will load the corresponding factory default preset. Alt plus number loads the user preset.
- Using multiple HDSP 9632s, clicking the button *Unit 2* while holding down Ctrl opens a second TotalMix window for the second HDSP system, instead of replacing the window contents.

The faders can also be moved pairwise, corresponding to the stereo-routing settings. This is achieved by pressing the **Alt**-key and is especially comfortable when setting the SPDIF and Phones output level. Even the panoramas can be operated with Alt, from stereo through mono to inversed channels, and also the Mute and Solo buttons (ganged or inversed switching!).

At the same time, TotalMix also supports combinations of these keys. If you press **Ctrl** and **Alt** at the same time, clicking with the mouse makes the faders jump to 0 dB pairwise, and they can be set pairwise by **Shift-Alt** in fine mode.

Also very useful: the faders have two mouse areas. The first area is the fader button, which can be grabbed at any place without changing the current position. This avoids unwanted changes when clicking onto it. The second area is the whole fader setting area. Clicking into this area makes the fader jump to the mouse at once. If for instance you want to set several faders to m.a., it is sufficient to click onto the lower end of the fader path. Which happens pairwise with the Alt-key pressed.

Using the hotkeys **I**, **O** and **P** the complete row of Input, Playback and Output channels each can be toggled between visible and invisible. Hotkey **S** switches Submix view on/off. Those four hotkeys have the same functionality as the buttons in the **View** section of the Quick Access Panel. The Level Meter Setup dialog can be opened via **F2** (as in DIGICheck). The dialog box Preferences is opened via **F3**.

Hotkey **M** toggles Mute Master on/off (and with this performs a global mute on/off). Hotkey **X** toggles the Matrix view on/off (see chapter 28), hotkey **T** the mixer view. Hotkey **L** links all faders as stereo pairs.

Further hotkeys are available to control the configuration of the Level Meter (see chapter 27.14):

Key **4** or **6**: Display range 40 or 60 dB

Key **E** or **R**: Numerical display showing Peak or RMS

Key **0** or **3**: RMS display absolute or relative to 0 dBFS

---

## 27.13 Menu Options

**Always on Top:** When active (checked) the TotalMix window will always be on top of the Windows desktop.

Note: This function may result in problems with windows containing help text, as the TotalMix window will even be on top of those windows, so the help text isn't readable.

**Deactivate Screensaver:** When active (checked) any activated Windows screensaver will be disabled temporarily.

**Ignore Position:** When active, the windows size and position stored in a file or preset will not be used. The routing will be activated, but the window will not change.

**ASIO Direct Monitoring (Windows only):** When de-activated any ADM commands will be ignored by TotalMix. In other words, ASIO Direct Monitoring is globally de-activated.

**Link Faders:** Selecting this option all faders will be treated as stereo pairs and moved pairwise. Hotkey L.

**Level Meter Setup:** Configuration of the Level Meters. Hotkey F2. See chapter 27.14.

**Preferences:** Opens a dialog box to configure several functions, like Pan Law, Dim, Talkback Dim, Listenback Dim. See chapter 27.10.

**Enable MIDI Control:** Turns MIDI control on. The channels which are currently under MIDI control are indicated by a colour change of the info field below the faders, black turns to yellow.

**Deactivate MIDI in Background:** Disables the MIDI control as soon as another application is in the focus, or in case TotalMix has been minimized.



## 27.14 Level Meter

The HDSP 9632 calculates all the display values Peak, Over and RMS in hardware, in order to be capable of using them independent of the software in use, and to significantly reduce the CPU load.

**Tip:** This feature, the **Hardware Level Meter**, is used by **DIGiCheck** (Windows only, see chapter 16) to display Peak/RMS level meters of all channels, nearly without any CPU load.

The level meters integrated in TotalMix - considering their size - cannot be compared with DIGiCheck. Nevertheless they already include many useful functions.

Peak and RMS is displayed for every channel. 'Level Meter Setup' (menu Options or F2) and direct keyboard entry (*hotkeys*) make various options available:

- Display range 40 or 60 dB (*hotkey 4 or 6*)
- Release time of the Peak display (Fast/Medium/Slow)
- Numerical display selectable either Peak or RMS (*Hotkey E or R*)
- Number of consecutive samples for Overload display (1 to 15)
- RMS display absolute or relative to 0 dBFS (*Hotkey 3 or 0*)

The latter is a point often overlooked, but nonetheless important. A RMS measurement shows 3 dB less for sine signals. While this is mathematically correct, it is not very reasonable for a level meter. Therefore the RMS readout is usually corrected by 3 dB, so that a full scale sine signal shows 0 dBFS on both Peak and RMS meters. This setting also yields directly readable signal-to-noise values. Otherwise the value shown with noise is 3 dB better than it actually is (because the reference is not 0 dB, but -3 dB). For example in WaveLab.

The value displayed in the text field is independent of the setting 40/60 dB, it represents the full 24 bit range of the RMS measurement, thus making possible a SNR measurement 'RMS unweighted', which you would otherwise need extremely expensive measurement devices for. An example: An *RME ADI-8 DS* connected to the HDSP 9632's ADAT port will show around -113 dBFS on all eight channel's input level meters.



This level display will constantly bring the reduced dynamic range of your equipment, maybe of the whole studio, in front of your eyes. Nice to have everything 24 bit - but still noise and hum everywhere in the range around -90 dB or worse... sorry, but this is the disappointing reality. The up-side about it is that TotalMix allows for constantly monitoring the signal quality without effort. Thus it can be a valuable tool for sound optimization and error removal in the studio.



*Measuring SNR (Signal to Noise) requires to press R (for RMS) and 0 (for referring to 0 dBFS, a full scale signal). The text display will then show the same value as an expensive measurement system, when measuring 'RMS unweighted'.*

---

## 28. TotalMix: The Matrix

### 28.1 Overview

The mixer window of TotalMix looks and operates similar to mixing desks, as it is based on a conventional stereo design. The matrix display presents a different method of assigning and routing channels, based on a single channel or monaural design. The matrix view of the HDSP looks and works like a conventional patchbay, adding functionality way beyond comparable hardware and software solutions. While most patchbays will allow you to connect inputs to outputs with just the original level (1:1, or 0 dB, as known from mechanical patchbays), TotalMix allows you to use a freely definable gain value per crosspoint.

Matrix and TotalMix are different ways of displaying the same processes. Because of this both views are always fully synchronized. Each change in one view is immediately reflected in the other view as well.

### 28.2 Elements of the Matrix View

The visual design of the TotalMix Matrix is mainly determined by the architecture of the HDSP system:

- Horizontal labels: All hardware outputs
- Vertical labels: All hardware inputs. Below are all playback channels (software playback channels)
- Green 0.0 dB field: Standard 1:1 routing
- Black gain field: Shows the current gain value as dB
- Orange gain field: This routing is muted.

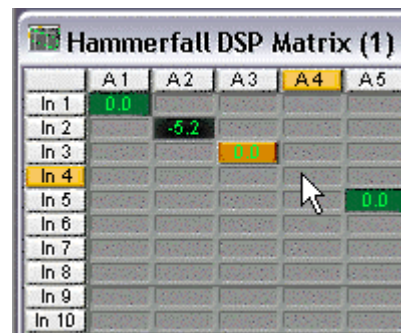

To maintain overview when the window size has been reduced, the left and upper labels are floating. They won't leave the visible area when scrolling.

### 28.3 Operation

Using the Matrix is a breeze. It is very easy to identify the current crosspoint, because the outer labels light up in orange according to the mouse position.

If input 1 is to be routed to output 1, use the mouse and click one time on crosspoint **In 1 / A 1**. The green 0.0 dB field pops in, another click removes it. To change the gain (equals the use of a different fader position, see simultaneous display of the mixer view), hold Ctrl down and drag the mouse up or down, starting from the gain field. The value within the field changes accordingly. The corresponding fader in the mixer view is moving simultaneously, in case the currently modified routing is visible.

Note the difference between the left side, representing the inputs and software playback channels, and the upper side, representing the hardware outputs. Moving a fader in row 1 or 2 in TotalMix view, only the specific levels (max. 2) of this routing will change within the Matrix. But moving a fader in row 3 will make all vertically activated levels move at once (for example 11/12, analog output).

A gain field marked orange indicates activated mute status. Mute can only be changed in the mixer view.

---

## 28.4 Advantages of the Matrix

The Matrix not always replaces the mixer view, but it significantly enhances the routing capabilities and - more important - is a brilliant way to get a fast overview of all active routings. It shows you in a glance what's going on. And since the Matrix operates monaural, it is very easy to set up specific routings with specific gains.

**Example 1:** You want TotalMix to route all software outputs to all corresponding hardware outputs, and have a submix of all inputs and software outputs on the Phones output (equals factory preset 2). Setting up such a submix is easy. But how to check at a later time, that all settings are still exactly the way you wanted them to be, not sending audio to a different output?

The most effective method to check a routing in mixer view is the Submix View, stepping through all existing software outputs, and having a very concentrated look at the faders and displayed levels of each routing. That doesn't sound comfortably nor error-free, right? Here is where the Matrix shines. In the Matrix view, you simply see a line from upper left to lower right, all fields marked as unity gain. Plus two rows vertically all at the same level setting. You just need 2 seconds to be sure no unwanted routing is active anywhere, and that all levels match precisely!

**Example 2:** The Matrix allows you to set up routings which would be nearly impossible to achieve by fiddling around with level and pan. Let's say you want to send input 1 to output 1 at 0 dB, to output 2 at -3 dB, to output 3 at -6 dB and to output 4 at -9 dB. Each time you set up the right channel (2/4), the change in pan destroys the gain setting of the left channel (1/2). A real hassle! In Matrix view, you simply click on the corresponding routing point, set the level via Ctrl-mouse, and move on. You can see in TotalMix view how pan changes to achieve this special gain and routing when performing the second (fourth...) setting.

## 29. TotalMix Super-Features

### 29.1 ASIO Direct Monitoring (Windows only)

Start Samplitude, Sequoia, Cubase or Nuendo and TotalMix. Activate ADM (ASIO Direct Monitoring), and move a fader in the ASIO host. Now watch the corresponding fader in TotalMix magically move too. TotalMix reflects all ADM gain and pan changes in realtime. Please note that faders only move when the currently activated routing (currently visible routing) corresponds to the one in the ASIO host. Also note that the Matrix will show any change, as it shows all possible routings in one view.

With this TotalMix has become a wonderful debugging tool for ADM. Just move the host's fader and pan, and see what kind of ADM commands TotalMix receives.

The hardware output row faders are included in all gain calculations, in every possible way. Example: you have lowered the output level of a submix, or just a specific channel, by some dB. The audio signal passed through via ADM will be attenuated by the value set in the third row.

---

## 29.2 Selection and Group-based Operation

Click on the white name label of channel 1 and 2 in TotalMix. Be sure to have channel 3's fader set to a different position and click on its label too. All three labels have changed to the colour orange, which means they are *selected*. Now moving any of these faders will make the other faders move too. This is called 'building a group of faders', or ganging faders, maintaining their relative position.

Building groups or ganging can be done in any row, but is limited to operate horizontally within one row. If you usually don't need this, you can at least gang the analog outputs. The advantage over holding the Alt-key is that Alt sets both channels to the same level (can be handy too), while grouping via selection will retain any offset (if you need one channel to be louder all the time etc.).

**Note:** The relative positions are memorized until the faders are pulled down so that they reach upper or lower maximum position *and* the group is changed (select another channel or deselect one of the group).

**Tip:** Gang some submixes and watch all routing levels change in the Matrix view.

## 29.3 Copy Routings to other Channels

TotalMix allows to copy complete routing schemes of inputs and outputs.

**Example 1:** You have input 5 (guitar) routed within several submixes/hardware outputs (= headphones). Now you'll get another input with keyboards that should appear in the same way on all headphones. Select input 5, open the menu *Edit*. It shows 'Copy In 5'. Now select the desired new input, for example In 8. The menu now shows 'Paste In 5 to In 8'. Click on it - done. If you are familiar with this functionality just use Ctrl-C and Ctrl-V. Else the self updating menu will always let you know what actually will happen.

**Tip:** Have the Matrix window open as second window when doing this. It will show the new routings immediately, so copying is easier to understand and to follow.

**Example 2:** You have built a comprehensive submix on outputs 4/5, but now need the exact same signal also on the outputs 6/7. Click on Out 4, Ctrl-C, click on Out 6, Ctrl-V, same with 5/7 - you're done!

The Matrix shows you the difference between both examples. Example 1 means copying lines (horizontally), while example 2 means copying rows (vertically).

**Example 3:** Let's say the guitarist finished his recording, and you now need the same signal again on all headphones, but this time it comes from the recording software (playback row). No problem, you can even copy between rows 1 and 2 (copying between row 3 and 1/2 isn't possible).

But how to select while a group is active? De-selecting the group first? Not necessary! TotalMix always updates the copy and paste process with the *last* selection. This way you don't have to de-activate any group-selections when desiring to perform a copy and paste action.

## 29.4 Delete Routings

The fastest way to delete complex routings: select a channel in the mixer view, click on the menu entry *Edit* and select *Delete*. Or simply hit the Del-key. Attention: there is no undo in TotalMix, so be careful with this function!

## 29.5 Recording a Subgroup (Loopback)

TotalMix supports a routing of the subgroup outputs (=hardware outputs, bottom row) to the recording software. Instead of the signal at the hardware input, the signal at the hardware output is sent to the record software. This way, complete submixes can be recorded without an external loopback cable. Also the playback of a software can be recorded by another software.

To activate this function, click on the white label in the third row while holding down the Ctrl-key. The label's colour changes to red. In case the channel has already been part of a group, the colour will change from yellow to orange, signalling that the group functionality is still active for this channel.

In loopback mode, the signal at the hardware input of the corresponding channel is no longer sent to the recording software, but still passed through to TotalMix. Therefore TotalMix can be used to route this input signal to any hardware output. Using the subgroup recording, the input can still be recorded on a different channel.

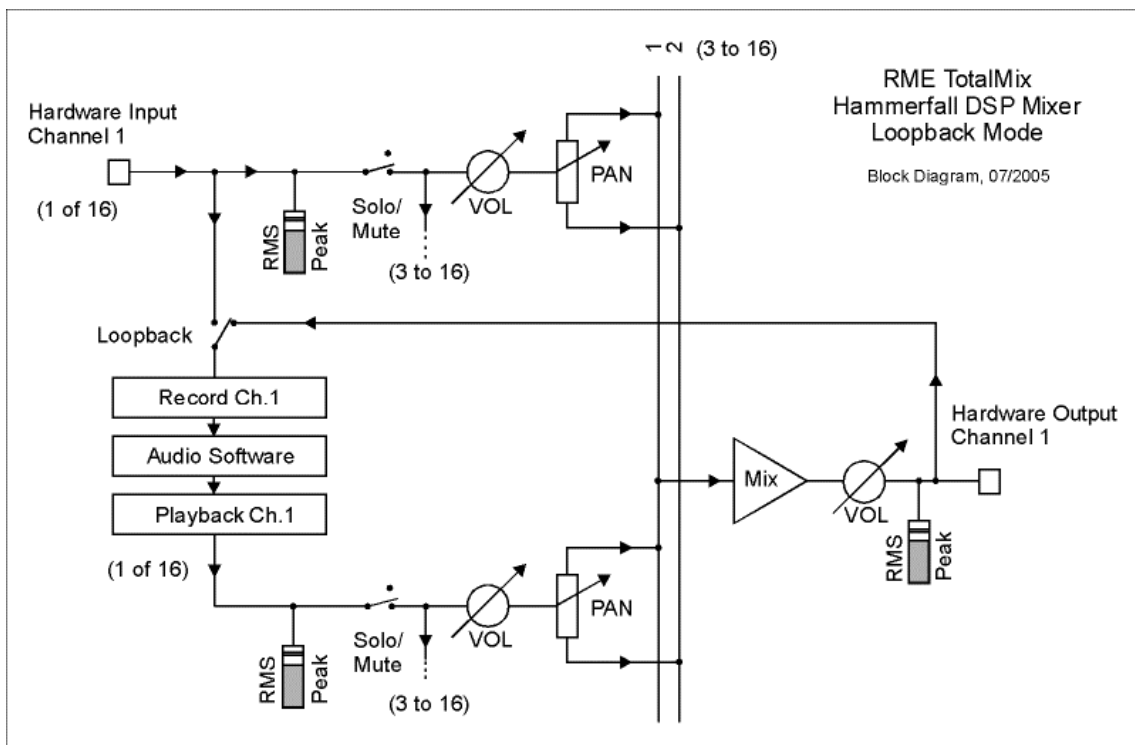

As each of the (up to) 16 hardware outputs can be routed to the record software, and none of these hardware inputs gets lost, TotalMix offers an overall flexibility and performance not rivaled by any other solution.

Additionally the risk of feedbacks, a basic problem of loopback methods, is highly reduced, because the feedback can not happen within the mixer, but only when the audio software is switched into monitoring mode. The block diagram shows how the software's input signal is played back, and fed back from the hardware output to the software input. A software monitoring on the subgroup record channels is only allowed as long as the monitoring is routed in both software and TotalMix to a different channel than the active subgroup recording one.

---

### Recording a Software's playback

In real world application, recording a software's output with another software will show the following problem: The record software tries to open the same playback channel as the playback software (already active), or the playback one has already opened the input channel which should be used by the record software.

This problem can easily be solved. First make sure that all rules for proper multi-client operation are met (not using the same record/playback channels in both programs). Then route the playback signal via TotalMix to a hardware output in the range of the record software, and activate this channel via Ctrl-mouse for recording.

### Mixing several input signals into one record channel

In some cases it is useful to record several sources in only one track. For example when using two microphones when recording instruments and loudspeakers. TotalMix' Loopback mode saves an external mixing desk. Simply route/mix the input signals to the same output (third row), then re-define this output into a record channel via Ctrl-mouse – that's it. This way any number of input channels from different sources can be recorded into one single track.

## 29.6 Using external Effects Devices

With TotalMix a usage of external hardware - like effects devices - is easy and flexible.

**Example 1:** The singer (microphone input channel 1) shall have some reverb on his headphones (outputs 11/12). A direct routing In 1 to Out 11/12 for monitoring had been set up already. The external reverb is connected to a free output, for example channel 8. In active mode Submix View click on channel 8 in the bottom row. Drag the fader of input 1 to about 0 dB and the panorama fully to the right. Adjust the input level at the reverb unit to an optimal setting. Next the output of the reverb unit is connected to a free stereo input, for example 5/6. Use the TotalMix level meters to adjust a matching output level at the reverb unit. Now click on channels 11/12 in the bottom row, and move the fader of inputs 5/6 until the reverb effect gets a bit too loud in the headphones. Now click on channel 8 in the bottom row again and drag fader 1 down a bit until the mix of original signal and reverb is perfect for the singer.

The described procedure is completely identical to the one when using an analog mixing desk. There the signal of the singer is sent to an output (usually labeled Aux), from there to a reverb unit, sent back from the reverb unit as stereo wet signal (no original sound), back in through a stereo input (e.g. Effect return) and mixed to the monitoring signal. The only difference: The Aux sends on mixing desks are post-fader. Changing the level of the original signal causes a change of the effects level (here the reverb) too, so that both always have the same ratio.

**Tip:** Such a functionality is available in TotalMix via the right mouse button! Dragging the faders by use of the right mouse button causes all routings of the current input or playback channel to be changed in a relative way. This completely equals the function **Aux post fader**.

**Example 2:** Inserting an effects device can be done as above, even within the record path. Other than in the example above the reverb unit also sends the original signal, and there is no routing of input 1 directly to outputs 11/12. To insert an effects device like a Compressor/Limiter directly into the record path, the input signal of channel 1 is sent by TotalMix to any output, to the Compressor, back from the Compressor to any input. This input is now selected within the record software.

Unfortunately, very often it is not possible within the record software to assign a different input channel to an existing track 'on the fly'. The loopback mode solves this problem elegantly. The routing scheme stays the same, with the input channel 1 sent to any output via TotalMix, to the Compressor, from the Compressor back to any input. Now this input signal is routed directly to output 1, and output 1 is then switched into loopback mode via Ctrl-mouse.

As explained in chapter 29.5, the hardware input of channel 1 now no longer feeds the record software, but is still connected to TotalMix (and thus to the Compressor). The record software receives the signal of submix channel 1 instead – the Compressor's return path.

## 30. TotalMix MIDI Remote Control

### 30.1 Overview

TotalMix can be remote controlled via MIDI. It is compatible to the widely spread Mackie Control protocol, so TotalMix can be controlled with all hardware controllers supporting this standard. Examples are the Mackie Control, Tascam US-2400 or Behringer BCF 2000.

Additionally, the stereo output faders (lowest row) which are set up as *Monitor Main* outputs in the Monitor panel can also be controlled by the standard **Control Change Volume** via **MIDI channel 1**. With this, the main volume of the HDSP 9632 is controllable from nearly any MIDI equipped hardware device.

### 30.2 Mapping

TotalMix supports the following Mackie Control surface elements\*:

<b>Element:</b>	<b>Meaning in TotalMix:</b>
Channel faders 1 – 8	volume
Master fader	Main Monitor channel's faders
SEL(1-8) + DYNAMICS	reset fader to Unity Gain
V-Pots 1 – 8	pan
pressing V-Pot knobs	pan = center
CHANNEL LEFT or REWIND	move one channel left
CHANNEL RIGHT or FAST FORWARD	move one channel right
BANK LEFT or ARROW LEFT	move eight channels left
BANK RIGHT or ARROW RIGHT	move eight channels right
ARROW UP or Assignable1/PAGE+	move one row up
ARROW DOWN or Assignable2/PAGE-	move one row down
EQ	Master Mute
PLUGINS/INSERT	Master Solo
STOP	Dim Main Monitor
PLAY	Talkback
PAN	Mono Main Monitor
MUTE Ch. 1 – 8	Mute
SOLO Ch. 1 – 8	Solo
SELECT Ch. 1 – 8	Select
REC Ch. 1 – 8	in Submix mode only: select output bus
F1 - F8	load preset 1 - 8
F9	select Main Monitor
F10 - F12	Monitor Phones 1 - 3

\*Tested with Behringer BCF2000 Firmware v1.07 in Mackie Control emulation for Steinberg mode and with Mackie Control under Mac OS X.

---

### 30.3 Setup

- Open the Preferences dialog (menu Options or F3). Select the MIDI Input and MIDI Output port where your controller is connected to.
- When no feedback is needed (when using only standard MIDI commands instead of Mackie Control protocol) select NONE as MIDI Output.
- Check *Enable MIDI Control* in the Options menu.

### 30.3 Operation

The channels being under MIDI control are indicated by a colour change of the info field below the faders, black turns to yellow.

The 8-fader block can be moved horizontally and vertically, in steps of one or eight channels.

Faders can be selected to gang them.

In Submix View mode, the current routing destination (output bus) can be selected via REC Ch. 1 – 8. This equals the selection of a different output channel in the lowest row by a mouse click when in Submix View. In MIDI operation it is not necessary to jump to the lowest row to perform this selection. This way even the routing can be easily changed via MIDI.

*Full LC Display Support:* This option in Preferences (F3) activates complete Mackie Control LCD support with eight channel names and eight volume/pan values.



*Attention: this feature causes heavy overload of the MIDI port when ganging more than 2 faders! In such a case, or when using the Behringer BCF2000, turn off this option.*

When *Full LC Display Support* is turned off, only a brief information about the first fader of the block (channel and row) is sent. This brief information is also available on the LED display of the Behringer BCF2000.

**Tip** for Mac OS X users: LC Xview ([www.opuslocus.com](http://www.opuslocus.com)) provides an on-screen display emulating the hardware displays of a Logic/Mackie Control, for use with controllers that can emulate a Logic/Mackie Control but do not have a display. Examples include the Behringer BCF2000 and Edirol PCR series.

*Deactivate MIDI in Background* (menu Options) disables the MIDI control as soon as another application is in the focus, or in case TotalMix has been minimized. This way the hardware controller will control the main DAW application only, except when TotalMix is in the foreground. Often the DAW application can be set to become inactive in background too, so that MIDI control is switched between TotalMix and the application automatically when switching between both applications.

TotalMix also supports the 9th fader of the Mackie Control. This fader (labeled Master) will control the stereo output faders (lowest row) which are set up as *Main Monitor* outputs in the Monitor panel. Always and only.



---

## 30.5 Simple MIDI Control

The stereo output faders (lowest row) which are set up as *Monitor Main* outputs in the Monitor panel can also be controlled by the standard **Control Change Volume** via **MIDI channel 1**. With this, the main volume of the HDSP 9632 is controllable from nearly any MIDI equipped hardware device.

Even if you don't want to control all faders and pans, some buttons are highly desired to be available in 'hardware'. These are mainly the *Talkback* and the *Dim* button, and the new monitoring options (listen to Phones submixes). Fortunately a Mackie Control compatible controller is not required to control these buttons, as they are steered by simple Note On/Off commands on MIDI channel 1.

The notes are (hex / decimal / keys):

**Monitor Main:** 3E / 62 / **D 3**

**Dim:** 5D / 93 / **A 5**

**Mono:** 2A / 42 / **#F 1**

**Talkback:** 5E / 94 / **#A 5**

**Monitor Phones 1:** 3F / 63 / **#D 3**

**Monitor Phones 2:** 40 / 64 / **E 3**

**Monitor Phones 3:** 41 / 65 / **F 3**

**Preset 1:** 36 / 54 / **#F 2**

**Preset 2:** 37 / 55 / **G 2**

**Preset 3:** 38 / 56 / **#G 2**

**Preset 4:** 39 / 57 / **A 2**

**Preset 5:** 3A / 58 / **#A 2**

**Preset 6:** 3B / 59 / **B 2**

**Preset 7:** 3C / 60 / **C 3**

**Preset 8:** 3D / 61 / **#C 3**

An example of a small MIDI controller covering such MIDI functionality (and even some more) is the **Behringer BCN44**. This little box has 4 pots and 8 buttons for all the above functions – for less than 60 Euros.

Furthermore TotalMix allows to control all faders of all three rows via simple **Control Change** commands.

The format for the Control Change commands is:

Bx yy zz

x = MIDI channel

yy = control number

zz = value

The first row in TotalMix is addressed by MIDI channels 0 up to 3, the middle row by channels 4 up to 7 and the bottom row by channels 8 up to 11.

16 Controller numbers are used: 102 up to 117 (= hex 66 bis 75).

With these 16 Controllers (= faders) and 4 MIDI channels each per row, up to 64 faders can be controlled per row (as required by the HDSPe MADI).

---

Examples for sending MIDI strings\*:

- Set input 1 to 0 dB: B0 66 40
- Set input 17 to maximum attenuation: B1 66 0
- Set playback 1 to maximum: B4 66 7F
- Set Output 16 to 0 dB setzen B8 75 40

\*Note: Sending MIDI strings might require to use programmer's logic for the MIDI channel, starting with 0 for channel 1 and ending with 15 for channel 16.

### 30.6 Loopback Detection

The Mackie Control protocol requires feedback of the received commands, back to the hardware controller. So usually TotalMix will be set up with both a MIDI input and MIDI output. Unfortunately any small error in wiring and setup will cause a MIDI feedback loop here, which then completely blocks the computer (the CPU).

To prevent the computer from freezing, TotalMix sends a special MIDI note every 0.5 seconds to its MIDI output. As soon as it detects this special note at the input, the MIDI functionality is disabled. After fixing the loopback, check *Enable MIDI Control* under Options to reactivate the TotalMix MIDI.

---

## User's Guide



# HDSP 9632

▶ **Technical Reference**

---

## 31. Tech Info

Not all information to and around our products fit in a manual. Therefore RME offers a lot more and detailed information in the **Tech Infos**. The very latest Tech Infos can be found on our website, section News & Infos, or the directory `\\rmeaudio.web\techinfo` on the RME Driver CD. These are some of the currently available *Tech Infos*:

Synchronization II (DIGI96 series)

Digital audio synchronization - technical background and pitfalls.

Installation problems - Problem descriptions and solutions.

Driver updates Hammerfall DSP – Lists all changes of the driver updates.

DIGICheck: Analysis, tests and measurements with RME audio hardware

A description of DIGICheck, including technical background information.

ADI-8 Inside

Technical information about the RME ADI-8 (24-bit AD/DA converter).

Many background information on laptops and tests of notebooks:

HDSP System: Notebook Basics - Notebook Hardware

HDSP System: Notebook Basics - The Audio Notebook in Practice

HDSP System: Notebook Basics - Background Knowledge and Tuning

HDSP System: Notebook Tests - Compatibility and Performance

The digital mixer of the Hammerfall DSP in theory and practise

HDSP System: TotalMix - Hardware and Technology

HDSP System: TotalMix - Software, features, operation

---

## 32. Technical Specifications

### 32.1 Analog

#### AD – Line In

- Resolution AD: 24 Bit
- Signal to Noise ratio (SNR): 109 dB RMS unweighted, 111 dBA @ 44.1 kHz
- THD @ -3 dBFS: -101 dB, < 0.001 %
- THD+N @ -3 dBFS: -99 dB, < 0.0015 %
- Crosstalk: 108 dB
- Frequency response AD @ 44.1 kHz, -0.5 dB: 5 Hz - 21.5 kHz
- Frequency response AD @ 96 kHz, -0.5 dB: 5 Hz – 45.3 kHz
- Frequency response AD @ 192 kHz, -1 dB: 5 Hz - 74 kHz
- Input Line: phono unbalanced, optional XLR balanced
- Input impedance: 10 kOhm
- Input sensitivity: Lo Gain, +4 dBu, -10 dBV
- Input level for 0 dBFS @ Lo Gain: +19 dBu
- Input level for 0 dBFS @ +4 dBu: +13 dBu
- Input level for 0 dBFS @ -10 dBV: +2 dBV

#### DA – Line Out

- Resolution DA: 24 Bit
- Signal to Noise ratio (SNR): 110 dB RMS unweighted, 112 dBA @ 44.1 kHz (unmuted)
- THD: < - 104 dB, < 0.00063 %
- THD+N: < -102 dB, < 0.0008 %
- Crosstalk: > 110 dB
- Maximum output level: +19 dBu
- Frequency response @ 44.1 kHz, -0.5 dB: 1 Hz – 21.1 kHz
- Frequency response @ 96 kHz, -0.5 dB: 1 Hz – 43.5 kHz
- Frequency response @ 192 kHz, -0.5 dB: 1 Hz – 70 kHz
- Output Line: phono unbalanced, optional XLR balanced
- Output impedance: 50 Ohm
- Output level: Hi Gain, +4 dBu, -10 dBV
- Output level at 0 dBFS @ Hi Gain: +19 dBu
- Output level at 0 dBFS @ +4 dBu: +13 dBu
- Output level at 0 dBFS @ -10 dBV: +2 dBV

#### DA - Stereo Monitor Output (Phones)

- Signal to Noise ratio (SNR): 110 dB RMS unweighted, 112 dBA @ 44.1 kHz (unmuted)
- THD: < - 100 dB, < 0.001 %
- THD+N: < -98 dB, < 0.0015 %
- Crosstalk: > 100 dB
- Frequency response @ 44.1 kHz, -0.5 dB: 1 Hz – 21.1 kHz
- Frequency response @ 96 kHz, -0.5 dB: 1 Hz – 43.5 kHz
- Frequency response @ 192 kHz, -0.5 dB: 1 Hz – 70 kHz
- Output: Standard 6.3 mm / 1/4" TRS jack
- Output XLR breakout cable: 6.3 mm / 1/4" TRS Neutrik jack, lockable
- Output impedance: 50 Ohm
- Output level @ 0 dB: +13 dBu
- Output level @ -6 dB: +7 dBu
- Output level @ -12 dB: +1 dBu

---

## 32.2 Digital Inputs

### SPDIF (AES/EBU)

- 1 x RCA (XLR), transformer-balanced, galvanically isolated, according to AES3-1992
- High-sensitivity input stage (< 0.3 Vpp)
- SPDIF compatible (IEC 60958)
- Accepts Consumer and Professional format, copy protection will be ignored
- Lock Range: 27 kHz – 200 kHz
- Jitter when synced to input signal: < 1 ns
- Jitter suppression: > 30 dB (2.4 kHz)

### ADAT Optical

- 1 x TOSLINK
- Standard: 8 channels 24 bit, up to 48 kHz
- Sample Split (S/MUX): 4 channels 24 bit 96 kHz
- Bitclock PLL ensures perfect synchronisation even in varispeed operation
- Lock Range: 31.5 kHz – 50 kHz
- Jitter when synced to input signal: < 1 ns
- Jitter suppression: > 30 dB (2.4 kHz)

### Word Clock

- BNC, not terminated (10 kOhm)
- Switch for internal termination 75 Ohm
- Automatic Double/Quad Speed detection and internal conversion to Single Speed
- SteadyClock guarantees super low jitter synchronization even in varispeed operation
- Transformer coupled, galvanically isolated input
- Not affected by DC-offsets within the network
- Signal Adaptation Circuit: signal refresh through auto-center and hysteresis
- Overvoltage protection
- Level range: 1.0 Vpp – 5.6 Vpp
- Lock Range: 27 kHz – 200 kHz
- Jitter when synced to input signal: < 1 ns
- Jitter suppression: > 30 dB (2.4 kHz)

## 32.3 Digital Outputs

### SPDIF

- 1 x RCA, transformer-balanced, galvanically isolated, according to AES3-1992
- Output level 0.8 Vpp
- Format Professional according to AES3-1992 Amendment 4
- Format Consumer (SPDIF) according to IEC 60958
- Single Wire mode, sample rate 28 kHz up to 200 kHz

### AES/EBU

as SPDIF, but XLR with output voltage 3.5 Vpp

### ADAT

- 1 x TOSLINK
- Standard: 8 channels 24 bit, up to 48 kHz
- Sample Split (S/MUX): 4 channels 24 bit 96 kHz
- In Quad Speed mode output of Single Speed sync frame

---

### **Word Clock**

- 2 x BNC, separated driver stage
- Max. output voltage: 5 Vpp
- Output voltage @ 75 Ohm termination: 4.0 Vpp
- Output impedance: 10 Ohm
- Frequency range: 27 kHz – 200 kHz

### **32.4 Digital**

- Clocks: Internal, ADAT In, SPDIF In, optional word clock in
- Low Jitter Design: < 1 ns in PLL mode, all inputs
- Internal clock: 800 ps Jitter, Random Spread Spectrum
- Jitter suppression of external clocks: > 30 dB (2.4 kHz)
- Effective clock jitter influence on AD and DA conversion: near zero
- PLL ensures zero dropout, even at more than 100 ns jitter
- Digital Bitclock PLL for trouble-free varispeed ADAT operation
- Supported sample rates: 28 kHz up to 200 kHz

### **32.5 MIDI**

- 1 x MIDI I/O via 5-pin DIN jacks
- Galvanically isolated by optocoupled input
- Hi-speed mode: Jitter and response time typically below 1 ms
- Separate 128 byte FIFOs for input and output

---

## 33. Technical Background

### 33.1 Lock and SyncCheck

Digital signals consist of a carrier and the data. If a digital signal is applied to an input, the receiver has to synchronize to the carrier clock in order to read the data correctly. To achieve this, the receiver uses a PLL (Phase Locked Loop). As soon as the receiver meets the exact frequency of the incoming signal, it is locked. This **Lock** state remains even with small changes of the frequency, because the PLL tracks the receiver's frequency.

If an ADAT or SPDIF signal is applied to the HDSP 9632, the unit indicates LOCK, i. e. a valid input signal. This information is presented in the HDSP 9632's Settings dialog. In the status display *SyncCheck*, the state of all clocks is decoded and shown as simple text (No Lock, Lock, Sync).

Unfortunately, LOCK does not necessarily mean that the received signal is correct with respect to the clock which processes the read out of the embedded data. Example [1]: The HDSP 9632 is set to 44.1 kHz internally (clock mode Master), and a mixing desk with ADAT output is connected to input ADAT. The status display will show LOCK immediately, but usually the mixing desk's sample rate is generated internally (it is Master too), and thus slightly higher or lower than the HDSP 9632's internal sample rate. Result: When reading out the data, there will frequently be read errors that cause clicks and drop outs.

Also when using multiple inputs, a simple LOCK is not sufficient. The above described problem can be solved elegantly by setting the HDSP 9632 from Master to AutoSync (its internal clock will then be the clock delivered by the mixing desk). But in case another un-synchronous device is connected, there will again be a slight difference in the sample rate, and therefore clicks and drop outs.

In order to display those problems, the HDSP 9632 includes **SyncCheck**<sup>®</sup>. It checks all clocks used for *synchronicity*. If they are not synchronous to each other, the status display will show LOCK. If they are synchronous to each other (i. e. absolutely identical), the status display will change to SYNC. In example 1 it would have been obvious that the entry LOCK is shown in *SyncCheck* after connecting the mixing desk.

In practice, SyncCheck allows for a quick overview of the correct configuration of all digital devices. So one of the most difficult and error-prone topics of the digital studio world finally becomes easy to handle.



---

## 33.2 Latency and Monitoring

The term **Zero Latency Monitoring** has been introduced by RME in 1998 for the DIGI96 series of audio cards. It stands for the ability to pass-through the computer's input signal at the interface directly to the output. Since then, the idea behind has become one of the most important features of modern hard disk recording. In the year 2000, RME published two ground-breaking Tech Infos on the topics *Low Latency Background*, which are still up-to-date: *Monitoring, ZLM and ASIO*, and *Buffer and Latency Jitter*, both found on the RME Driver CD and the RME website.

### How much Zero is Zero?

From a technical view there is no zero. Even the analog pass-through is subject to phase errors, equalling a delay between input and output. However, delays below certain values can subjectively be claimed to be a zero-latency. This applies to analog routing and mixing, and in our opinion also to RME's Zero Latency Monitoring. The term describes the digital path of the audio data from the input of the interface to its output. The digital receiver of the HDSP 9632 can't operate un-buffered, and together with TotalMix and the output via the transmitter, it causes a typical delay of 3 samples. At 44.1 kHz this equals about 68  $\mu$ s (0.000068 s). In Double Speed mode, the delay doubles to 6 samples, for both ADAT and SPDIF.

### Oversampling

While the delays of digital interfaces can be disregarded altogether, the analog inputs and outputs do cause a significant delay. Modern converter chips operate with 64 or 128 times oversampling plus digital filtering, in order to move the error-prone analog filters away from the audible frequency range as far as possible. This typically generates a delay of one millisecond. A playback and re-record of the same signal via DA and AD (loopback) then causes an offset of the newly recorded track of about 2 ms. The exact delays of the HDSP 9632 are:

Sample frequency kHz	44.1	48	88.2	96	176.4	192
AD (43.2 x 1/fs) ms	0.98	0.9	0.49	0.45		
AD (38.2 x 1/fs) ms					0.22	0.2
DA (43.4 x 1/fs) ms	0.98	0.9				
DA (87.5 x 1/fs) ms			0.99	0.91		
DA (176.8 x 1/fs) ms					1	0.92

### Buffer Size (Latency)

*Windows:* This option found in the Settings dialog defines the size of the buffers for the audio data used in ASIO and GSIF (see chapter 13 and 14).

*Mac OS X:* The buffer size is defined within the application. Only some do not offer any setting. For example iTunes is fixed to 512 samples.

*General:* A setting of 64 samples at 44.1 kHz causes a latency of 1.5 ms, for record and playback each. But when performing a digital loopback test no latency/offset can be detected. The reason is that the software naturally knows the size of the buffers, therefore is able to position the newly recorded data at a place equalling a latency-free system.

*AD/DA Offset under ASIO and OS X:* ASIO (Windows) and Core Audio (Mac OS X) allow for the signalling of an offset value to correct buffer independent delays, like AD- and DA-conversion or the Safety Buffer described below. An analog loopback test will then show no offset, because the application shifts the recorded data accordingly. Because in real world operation analog record and playback is unavoidable, the drivers include an offset value matching the HDSP 9632's converter delays.

---

Therefore, in a **digital** loopback test a *negative* offset of about 2 ms occurs. This is no real problem, because this way of working is more than seldom, and usually the offset can be compensated manually within the application. Additionally, keep in mind that even when using the digital I/Os usually at some place an AD- and DA-conversion is involved (no sound without DA-conversion...).

Note: Cubase and Nuendo display the latency values signalled from the driver separately for record and playback. While with our digital cards these values equal exactly the buffer size (for example 3 ms at 128 samples), the HDSP 9632 displays an additional millisecond – the time needed for the AD/DA-conversion.

### Core Audios Safety Offset

Under OS X, every audio interface has to use a so called *safety offset*, otherwise Core Audio won't operate click-free. The HDSP 9632 uses a safety offset of 32 samples. This offset is signalled to the system, and the software can calculate and display the total latency of buffer size plus AD/DA offset plus safety offset for the current sample rate.

### 33.3 DS - Double Speed

When activating the *Double Speed* mode the HDSP 9632 operates at double sample rate. The internal clock 44.1 kHz turns to 88.2 kHz, 48 kHz to 96 kHz. The internal resolution is still 24 bit.

Sample rates above 48 kHz were not always taken for granted, and are still not widely used because of the CD format (44.1 kHz) dominating everything. Before 1998 there were no receiver/transmitter circuits available that could receive or transmit more than 48 kHz. Therefore a work-around was used: instead of two channels, one AES line only carries one channel, whose odd and even samples are being distributed to the former left and right channels. By this, you get the double amount of data, i. e. also double sample rate. Of course in order to transmit a stereo signal two AES/EBU ports are necessary then.

This transmission mode is called *Double Wire* in the professional studio world, and is also known as *S/MUX* (abbreviation for *Sample Multiplexing*) in connection with the ADAT format. The AES3 specification uses the uncommon term *Single channel double sampling frequency mode*.

Not before February 1998, Crystal shipped the first 'single wire' receiver/transmitters that could also work with double sample rate. It was then possible to transmit two channels of 96 kHz data via one AES/EBU port.

But *Double Wire* is still far from being dead. On one hand, there are still many devices which can't handle more than 48 kHz, e. g. digital tape recorders. But also other common interfaces like ADAT or TDIF are still using this technique.

Because the ADAT interface does not allow for sampling frequencies above 48 kHz (a limitation of the interface hardware), the HDSP 9632 automatically uses the *Sample Multiplexing* method in DS mode. One channel's data is distributed to two channels according to the following table:

ADAT Ch.	1	2	3	4	5	6	7	8
DS Channel	1	1	2	2	3	3	4	4
Samples	1a	1b	2a	2b	3a	3b	4a	4b

As the transmission of double rate signals is done at standard sample rate (Single Speed), the ADAT outputs still deliver 44.1 kHz or 48 kHz.

The SPDIF (AES) output of the HDSP 9632 provides 96 kHz as Single Wire only.

### 33.4 QS – Quad Speed

Due to the small number of available devices that use sample rates up to 192 kHz, but even more due to a missing real world application (CD...), Quad Speed has had no broad success so far. An implementation of the ADAT format as double S/MUX (S/MUX4) results in only two channels per optical output. Devices using this method are few.

In earlier times the transmission of 192 kHz had not been possible via Single Wire, so once again sample multiplexing was used: instead of two channels, one AES line transmits only one half of a channel. A transmission of one channel requires two AES/EBU lines, stereo requires even four. This transmission mode is being called *Quad Wire* in the professional studio world, and is also known as *S/MUX4* in connection with the ADAT format. The AES3 specification does not mention Quad Wire.

The SPDIF (AES) output of the HDSP 9632 provides 192 kHz as Single Wire only.

### 33.5 AES/EBU - SPDIF

The most important electrical properties of 'AES' and 'SPDIF' can be seen in the table below. AES/EBU is the professional balanced connection using XLR plugs. The standard is being set by the *Audio Engineering Society* based on the AES3-1992. For the 'home user', SONY and Philips have omitted the balanced connection and use either Phono plugs or optical cables (TOSLINK). The format called S/P-DIF (SONY/Philips Digital Interface) is described by IEC 60958.

Type	AES3-1992	IEC 60958
Connection	XLR	RCA / Optical
Mode	Balanced	Un-balanced
Impedance	110 Ohm	75 Ohm
Level	0.2 V up to 5 V <sub>ss</sub>	0.2 V up to 0.5 V <sub>ss</sub>
Clock accuracy	not specified	I: ± 50ppm II: 0,1% III: Variable Pitch
Jitter	< 0.025 UI (4.4 ns @ 44.1 kHz)	not specified

Besides the electrical differences, both formats also have a slightly different setup. The two formats are compatible in principle, because the audio information is stored in the same place in the data stream. However, there are blocks of additional information, which are different for both standards. In the table, the meaning of the first byte (#0) is shown for both formats. The first bit already determines whether the following bits should be read as Professional or Consumer information.

Byte	Mode	Bit 0	1	2	3	4	5	6	7
0	Pro	P/C	Audio?	Emphasis			Locked	Sample Freq.	
0	Con	P/C	Audio?	Copy	Emphasis			Mode	

It becomes obvious that the meaning of the following bits differs quite substantially between the two formats. If a device like a common DAT recorder only has an SPDIF input, it usually understands only this format. In most cases, it will switch off when being fed Professional-coded data. The table shows that a Professional-coded signal would lead to malfunctions for copy prohibition and emphasis, if being read as Consumer-coded data.

Nowadays many devices with SPDIF input can handle Professional subcode. Devices with AES3 input almost always accept Consumer SPDIF (passive cable adapter necessary).

### 33.6 Noise level in DS / QS Mode

The outstanding signal to noise ratio of the HDSP 9632's AD-converters can be verified even without expensive test equipment, by using record level meters of various software. But when activating the DS and QS mode, the displayed noise level will rise from -109 dB to -104 dB at 96 kHz, and -82 dB at 192 kHz. This is not a failure. The software measures the noise of the whole frequency range, at 96 kHz from 0 Hz to 48 kHz (RMS unweighted), at 192 kHz from 0 Hz to 96 kHz.

When limiting the measurement's frequency range to 22 kHz (audio bandpass, weighted) the value would be -109 dB again. This can be verified even with RME's Windows tool *DIGiCheck*. Although a dBA weighted value does not include such a strong bandwidth limitation as audio bandpass does, the displayed value of -108 dB is nearly identical to the one at 48 kHz.

Subframe	MSB	Audio Data	LSB	AUX	CUV	RMS [dB+3]	RMS [dBA+3]	DC [dB]
1 - Left	*****	*****	*****	*****	00	-81.9	-108.5	LOW
2 - Right	*****	*****	*****	*****	00	-82.1	-108.9	LOW
Bits	4	8	12	16	20	24		

The reason for this behaviour is the noise shaping technology of the analog to digital converters. They move all noise and distortion to the in-audible higher frequency range, above 24 kHz. That's how they achieve their outstanding performance and sonic clarity. Therefore the noise is slightly increased in the ultrasound area. High-frequent noise has a high energy. Add the doubled (quadrupled) bandwidth, and a wideband measurement will show a significant drop in SNR, while the human ear will notice absolutely no change in the audible noise floor.

### 33.7 SteadyClock

The SteadyClock technology of the HDSP 9632 guarantees an excellent performance in all clock modes. Thanks to a highly efficient jitter suppression, the AD- and DA-conversion always operates on highest sonic level, being completely independent from the quality of the incoming clock signal.

SteadyClock has been originally developed to gain a stable and clean clock from the heavily jittery MADi data signal (the embedded MADi clock suffers from about 80 ns jitter). Using the 9632's input signals SPDIF, ADAT or word clock, you'll most probably never experience such high jitter values. But SteadyClock is not only ready for them, it would handle them just on the fly.

Common interface jitter values in real world applications are below 10 ns, a very good value is less than 2 ns.

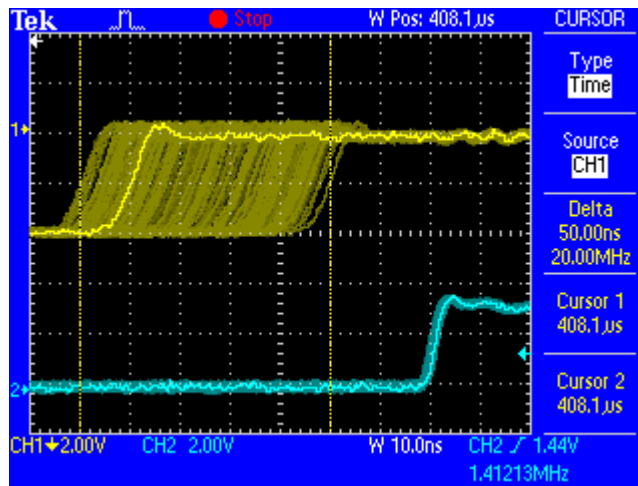

The screenshot shows an extremely jittery SPDIF signal of about 50 ns jitter (top graph, yellow). SteadyClock turns this signal into a clock with less than 2 ns jitter (lower graph, blue). The signal processed by SteadyClock is of course not only used internally, but also used to clock the digital outputs. Therefore the refreshed and jitter-cleaned signal can be used as reference clock without hesitation.

## 34. Diagrams

### 34.1 Block Diagram HDSP 9632

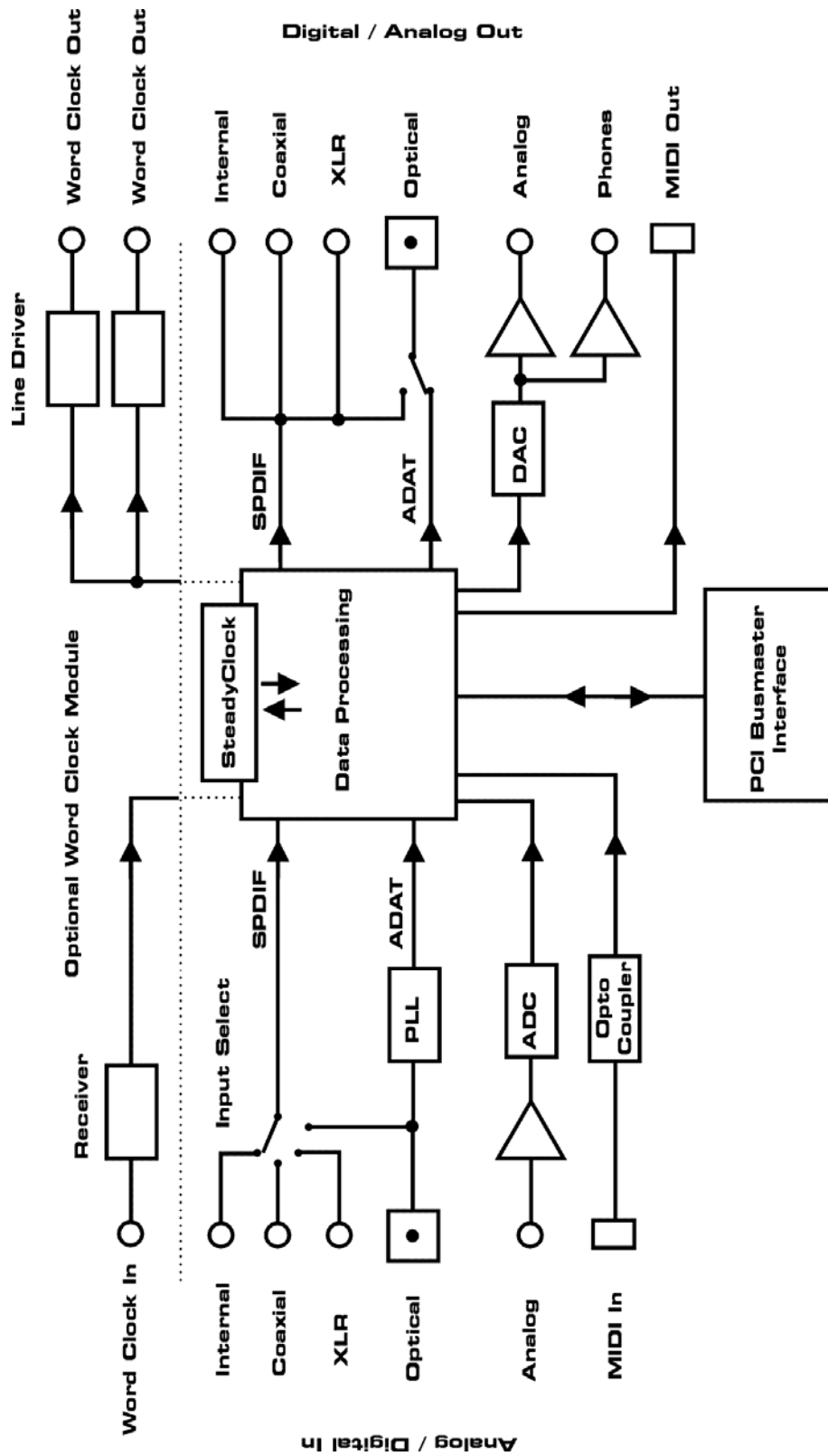

## 34.2 Connector Pinouts

### TRS jacks of analog input / output

The stereo ¼" TRS jacks of the analog inputs and outputs are wired according to international standards:

Tip = + (hot)      Ring = – (cold)      Sleeve = GND

The servo balanced input and output circuitry allows to use monaural TS jacks (unbalanced) with no loss in level. This is the same as when using a TRS-jack with ring connected to ground.

### TRS Phones jack

The analog monitor output on the front is accessible through a stereo ¼" TRS jack. This allows a direct connection of headphones. In case the output should operate as Line output, an adapter TRS plug to RCA phono plugs, or TRS plug to TS plugs is required.

The pin assignment follows international standards. The left channel is connected to the tip, the right channel to the ring of the TRS jack/plug.

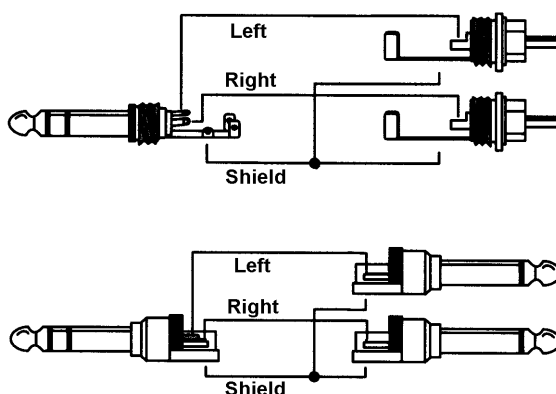

### Pin assignment of the 9-pin D-type connector, breakout cable SPDIF / AES

Note: The digital breakout cable is identical to the one used in the DIGI96 series.

Pin	Name	Pin	Name	Pin	Name
1	GND	4	AES Out +	7	SPDIF In -
2	SPDIF Out +	5	AES In +	8	AES Out -
3	SPDIF In +	6	SPDIF Out -	9	AES In -

### Pin assignment of the 15-pin D-type connector and analog XLR breakout cable

Pin	Name	Pin	Name	Pin	Name
1	Line In Left -	6	Line In Left +	11	Line In Right -
2	Line In Right +	7	Line Out Left -	12	Line Out Left +
3	Line Out Right +	8	Line Out Right -	13	Phones Left
4	MIDI Out (5)	9	GND/Shell	14	Phones Right
5	MIDI In (4)	10	MIDI In (5)	15	MIDI Out (4)

### Pin assignment of the analog RCA/phono breakout cable

Pin	Name	Pin	Name	Pin	Name
1	GND/Shell	6	Line In Left +	11	GND/Shell
2	Line In Right +	7	n.c.	12	Line Out Left +
3	Line Out Right +	8	n.c.	13	Phones Left
4	MIDI Out (5)	9	GND/Shell	14	Phones Right
5	MIDI In (4)	10	MIDI In (5)	15	MIDI Out (4)

---

### 34.3 Overview Channels / Expansion Boards

#### Overview channel count in Single, Double and Quad Speed

SF / Port	SPDIF	ADAT	Analog	AI	AO	AEB	TEB	Max
48 kHz	2	8	2	4	4	8	8	16
96 kHz	2	4	2	4	4		4	12
192 kHz	2		2	4	4			4

#### Overview possible combinations HDSP9632 / Expansion Boards

Card		Expansion Boards						
SPDIF	Analog	ADAT I	ADAT O	AI	AO	AEB I	AEB O	TEB
X	X	X	X	X	X		X	
X	X	X	X	X	X		X	
X	X		X	X	X	X	X	
X	X		X	X	X			X

SPDIF: SPDIF On-Board  
 Analog: 2 channel Line I/O on-board  
 ADAT I: ADAT input on-board  
 ADAT O: ADAT output on-board  
 AI: AI4S-192, 4 channel Line in expansion board  
 AO: AO4S-192, 4 channel Line out expansion board  
 AEB I: 4/8 channel Line in expansion board  
 AEB O: 4/8 channel Line out expansion board  
 TEB: TDIF expansion board