

KAWAI

CN29 Owner's Manual

Introduction

Playing the Piano

Music Menu

Recorder

Settings

Appendix

EN

Thank you for purchasing this Kawai CN29 digital piano.

This owner's manual contains important information regarding the instrument's usage and operation.

Please read all sections carefully, keeping this manual handy for future reference.

■ About this Owner's Manual

Before attempting to play this instrument, please read the **Introduction** section from page 10 of this owner's manual. This section explains the name and function of each part, how to connect the power cable, and how to turn on the power.

The **Playing the Piano** section (page 18) provides an overview of the instrument's most commonly used functions, allowing the CN29 digital piano to be enjoyed almost immediately after being connected, while the **Music Menu** section (page 24) includes information regarding the built-in demonstration songs, Concert Magic songs, and Lesson function.

The **Recorder** section (page 34) provides instructions on how to record and play back pieces stored in the instrument's internal memory, and the **Settings** section (page 37) details the settings that can be used to adjust a number of sound and keyboard characteristics, as well as system settings.

Finally, the **Appendix** section (page 52) includes listings for all demo, Concert Magic, and Lesson function songs, a troubleshooting guide, assembly instructions, and full specification details.

Important Safety Instructions

SAVE THESE INSTRUCTIONS

INSTRUCTIONS PERTAINING TO A RISK OF FIRE, ELECTRIC SHOCK, OR INJURY TO PERSONS



WARNING

TO REDUCE THE RISK OF FIRE OR ELECTRIC SHOCK, DO NOT EXPOSE THIS PRODUCT TO RAIN OR MOISTURE.

AVIS : RISQUE DE CHOC ELECTRIQUE - NE PAS OUVRIR.

TO REDUCE THE RISK OF ELECTRIC SHOCK, DO NOT OPEN THE AC ADAPTOR.
NO USER-SERVICEABLE PARTS INSIDE. REFER SERVICING TO QUALIFIED SERVICE PERSONNEL.



The lightning flash with arrowhead symbol, within an equilateral triangle, is intended to alert the user to the presence of uninsulated "dangerous voltage" within the product's enclosure that may be of sufficient magnitude to constitute a risk of electric shock to persons.



The exclamation point within an equilateral triangle is intended to alert the user to the presence of important operating and maintenance (servicing) instructions in the literature accompanying the product.

Examples of Picture Symbols



Denotes that care should be taken.
The example instructs the user to take care not to allow fingers to be trapped.



Denotes a prohibited operation.
The example instructs that disassembly of the product is prohibited.



Denotes an operation that should be carried out.
The example instructs the user to remove the power cord plug from the AC outlet.

Read all the instructions before using the product.

- 1) Read these instructions.
- 2) Keep these instructions.
- 3) Heed all warnings.
- 4) Follow all instructions.
- 5) Do not use this apparatus near water.
- 6) Clean only with dry cloth.
- 7) Do not block any ventilation openings. Install in accordance with the manufacturer's instructions.
- 8) Do not install near any heat sources such as radiators, heat registers, stoves, or other apparatus (including amplifiers) that produce heat.
- 9) Do not defeat the safety purpose of the polarized or grounding-type plug. A polarized plug has two blades with one wider than the other. A grounding type plug has two blades and a third grounding prong. The wide blade or the third prongs are provided for your safety. If the provided plug does not fit into your outlet, consult an electrician for replacement of the obsolete outlet.
- 10) Protect the power cord from being walked on or pinched particularly at plugs, convenience receptacles, and the point where they exit from the apparatus.
- 11) Only use attachments/accessories specified by the manufacturer.
- 12) Use only with the cart, stand, tripod, bracket, or table specified by the manufacturer, or sold with the apparatus. When a cart is used, use caution when moving the cart/apparatus combination to avoid injury from tip-over. 
- 13) Unplug this apparatus during lightning storms or when unused for long periods of time.
- 14) Refer all servicing to qualified service personnel. Servicing is required when the apparatus has been damaged in any way, such as power-supply cord or plug is damaged, liquid has been spilled or objects have fallen into the apparatus, the apparatus has been exposed to rain or moisture, does not operate normally, or has been dropped.

WARNING - When using electric products, basic precautions should always be followed, including the following.



WARNING

Indicates a potential hazard that could result in death or serious injury if the product is handled incorrectly.

The product should be connected to an AC outlet of the specified voltage.

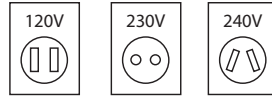

- If you are going to use an AC power cord, make sure that it has the correct plug shape and conforms to the specified power voltage.
- Failure to do so may result in fire.

Do not insert or disconnect the power cord plug with wet hands.



Doing so may cause electric shock.

Take care not to allow any foreign matter to enter the product.

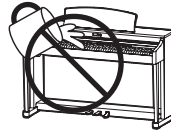

Entry of water, needles or hair pins may result in breakdown or short-circuit. The product shall not be exposed to dripping or splashing. No objects filled with liquids, such as vases, shall be placed on the product.

The chair must be used properly (it must be used only when playing the product).

- Do not play with it or stand on it.
- Only one person is allowed to sit on it.
- Do not sit on it when opening the lid.
- Re-tighten the bolts occasionally.

Doing so may cause the chair to fall over or your fingers to be trapped, resulting in injury.

When using the headphones, do not listen for long periods of time at high volume levels.



Doing so may result in hearing problems.

Do not lean against the keyboard.

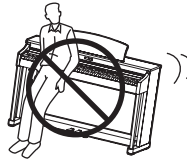

Doing so may cause the product to fall over, resulting in injury.

Do not disassemble, repair or modify the product.

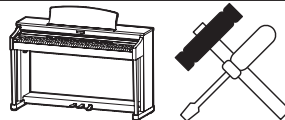

Doing so may result in product breakdown, electric shock or short-circuit.

When disconnecting the AC power cord's plug, always hold the plug and pull it to remove it.



- Pulling the AC power cord itself may damage the cord, causing a fire, electric shock or short-circuit.

The product is not completely disconnected from the power supply even when the power switch is turned off. If the product will not be used for a long time, unplug the AC power cord from the AC outlet.



- Failure to do so may cause fire in case of lightning.
- Failure to do so may over-heat the product, resulting in fire.

This product may be equipped with a polarized line plug (one blade wider than the other). This is a safety feature. If you are unable to insert the plug into the outlet, contact an electrician to replace your obsolete outlet. Do not defeat the safety purpose of the plug.

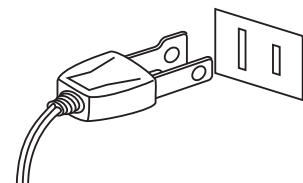

It is a good practice to have the instrument near the AC outlet and the power cord plug in a position so that it can readily be disconnected in an emergency because electricity is always charging while the plug is in the AC outlet even in a power switch off condition.



CAUTION

Indicates a potential hazard that could result in injury or damage to the product or other property if the product is handled incorrectly.

Do not use the product in the following areas.

- Areas, such as those near windows, where the product is exposed to direct sunlight
- Extremely hot areas, such as near a heater
- Extremely cold areas, such as outside
- Extremely humid areas
- Areas where a large amount of sand or dust is present
- Areas where the product is exposed to excessive vibrations

Using the product in such areas may result in product breakdown. Use the product only in moderate climates (not in tropical climates).

Use only the AC adaptor included with this instrument to power the instrument.

- Do not use other AC adaptors to power this instrument.
- Do not use the included AC adaptor or AC power cord to power other equipment.

When you close the keyboard cover, close it gently.



Closing it roughly may trap your fingers, resulting in injury.

Before connecting cords, make sure that the power to this product and other devices is turned OFF.

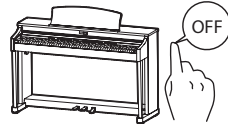

Failure to do so may cause breakdown of this product and other devices.

Do not drag the product on the floor. Take care not to drop the product.

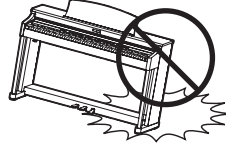

Please lift up the product when moving it. Please note that the product is heavy and must be carried by more than two persons. Dropping the product may result in breakdown.

Do not place the product near electrical appliances such as TVs and radios.

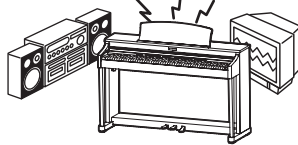

- Doing so may cause the product to generate noise.
- If the product generates noise, move the product sufficiently away from the electrical appliance or connect it to another AC outlet.

When connecting the AC power cord and other cords, take care not to get them tangled.



Failure to do so may damage them, resulting in fire, electric shock or short-circuit.

Do not wipe the product with benzene or thinner.



- Doing so may result in discoloration or deformation of the product.
- When cleaning the product, put a soft cloth in lukewarm water, squeeze it well, then wipe the product.

Do not stand on the product or exert excessive force.



Doing so may cause the product to become deformed or fall over, resulting in breakdown or injury.

Do not place naked flame, such as lighted candles on the product.

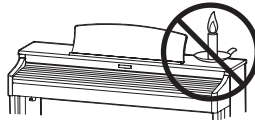

Doing so may cause the illumination to fall over, resulting in fire.

Ensure that the ventilation is not impeded by covering the ventilation openings with items, such as newspaper, table-cloths, curtains, etc.

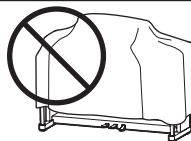

Failure to do so may over-heat the product, resulting in fire.

The product should be located so that its location or position does not interfere with its proper ventilation. Ensure a minimum distance of 5cm around the product for sufficient ventilation.

The product should be serviced by qualified service personnel when:

- The power supply cord or the plug has been damaged.
- Objects have fallen, or liquid has been spilled into the product.
- The product has been exposed to rain.
- The product does not appear to operate normally or exhibits a marked change in performance.
- The product has been dropped, or the enclosure damaged.

Notes on Repair

Should an abnormality occur in the product, immediately turn the power OFF, disconnect the power cord plug, and then contact the shop from which the product was purchased.

CAUTION:

To prevent electric shock, match wide blade of plug to wide slot, fully insert.

ATTENTION:

Pour éviter les chocs électriques, introduire la lame la plus large de la fiche dans la borne correspondante de la prise et pousser jusqu'au fond.



An information on Disposal for users

If your product is marked with this recycling symbol it means that, at the end of its life, you must dispose of it separately by taking it to an appropriate collection point.

You should not mix it with general household waste. Disposing of this product correctly will prevent potential negative effects on the environment and human health which could otherwise arise due to inappropriate waste handling.

For further details, please contact your local authority.
(European Union only)

Instruction for AC power cord (U.K.)

IMPORTANT

THE WIRES IN THIS MAINS LEAD ARE COLOURED IN ACCORDANCE WITH THE FOLLOWING CODE.

BLUE : NEUTRAL
BROWN : LIVE

As the colours of the wires in the mains lead of this apparatus may not correspond with the coloured markings identifying the terminals in your plug, proceed as follows:

The wire which is coloured BLUE must be connected to the terminal which is marked with the letter N or coloured BLACK.

The wire which is coloured BROWN must be connected to the terminal which is marked with the letter L or coloured RED.

Do not plug either terminal of the power cord to the the ground od AC outlet on the wall.

FCC Information (U.S.A)

CAUTION: Changes or modifications not expressly approved by the party responsible for compliance could void the user's authority to operate the equipment.

NOTE: This equipment has been tested and found to comply with the limits for a Class B digital device, pursuant to Part 15 of the FCC Rules. These limits are designed to provide reasonable protection against harmful interference in a residential installation. This equipment generates, uses and can radiate radio frequency energy and, if not installed and used in accordance with the instructions, may cause harmful interference to radio communications. However, there is no guarantee that interference will not occur in a particular installation. If this equipment does cause harmful interference to radio or television reception, which can be determined by turning the equipment off and on, the user is encouraged to try to correct the interference by one or more of the following measures:

- Reorient or relocate the receiving antenna.
- Increase the separation between the equipment and receiver.
- Connect the equipment into an outlet on a circuit different from that to which the receiver is connected.
- Consult the dealer or an experienced radio/TV technician for help.

Declaration of Conformity

Products :	Electronic Piano
Model Number :	CN29
Responsible Party Name :	Kawai America Corporation
Address :	2055 East University Drive Rancho Dominguez, CA 90220
Telephone :	310-631-1771

This device complies with Part 15 of the FCC Rules.

Operation is subject to the following two conditions:

- (1) this device may not cause harmful interference, and
- (2) this device must accept any interference received, including interference that may cause undesired operation.

This applies only to products distributed by Kawai America Corporation.

The nameplate label is located on the underside of the instrument, as indicated below.

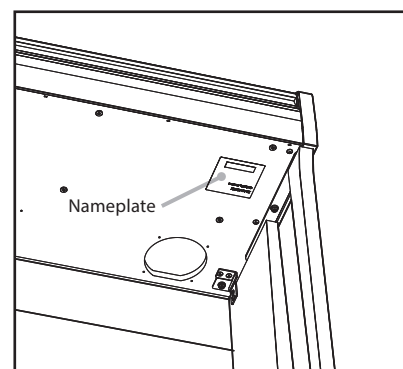

About Bluetooth

- The Bluetooth® word mark and logos are registered trademarks owned by the Bluetooth SIG, Inc. and any use of such marks by Kawai Musical Instruments Mfg. Co., Ltd. is under license. Other trademarks and trade names are those of their respective owners.
- Frequency Band of Radio: 2400~2483.5 MHz Maximum Transmit Power: 2.5 mW
- Availability of Bluetooth function dependent on market location.



Table of Contents

Important Safety Instructions	4
Table of Contents	9

Introduction

Welcome to the Kawai CN29 digital piano.	10
1. Feature Highlights	10
2. Owner's Manual Conventions	11
Part Names and Functions	12
Setting up the Piano	14
1. Power	14
2. Key cover and music rest	15
3. Volume and headphones	16
4. Pedals	17

Playing the Piano

Selecting Sounds	18
Dual Mode	19
Four Hands Mode	21
Metronome	22

Music Menu

Demo Songs	24
Concert Magic	25
Concert Magic song arrangement types	27
Concert Magic playing mode	28
Concert Magic demo mode	29
Lesson Function	30
1. Selecting a lesson book and song	30
2. Listening to the selected lesson song	32
3. Practicing left and right-hand parts separately	33

Recorder

Recorder	34
1. Recording a song	34
2. Playing back a song	35
3. Deleting a song	36

Settings

Settings Menu	37
1. Reverb	38
2. Transpose	39
3. Tone Control	40
4. Dual	41
5. Four Hands	41
6. Tuning	41
7. Touch	42
8. Smart Mode Virtual Technician	43
9. Damper Noise	44
10. Key Volume	45
11. Spatial Headphone Sound	46
12. Phones Type	47
13. Bluetooth MIDI	48
14. MIDI Settings	49
15. Auto Display Off	49
16. Auto Power Off	50
17. Startup Settings	51
18. Factory Reset	51

Appendix

Connecting to Other Devices	52
USB MIDI (USB to Host connector)	53
Troubleshooting	54
Assembly Instructions	55
Demo Song List	59
Concert Magic Song List	59
Lesson Function Song Lists	60
Specifications	62

* For information regarding MIDI functions and settings, please download the supplementary PDF manual from the Kawai Global website: <http://www.kawai-global.com/support/manual>

Welcome to the Kawai CN29 digital piano

1 Feature Highlights

'Responsive Hammer III' weighted-key action, with Ivory Touch key surfaces and Let-off simulation

The CN29 digital piano's *Responsive Hammer III* (RHIII) action recreates the distinctive touch of an acoustic grand piano, with its realistic movement and accurate 3-sensor technology providing a smooth, natural, and highly responsive piano playing experience. The weight of the keyboard is appropriately graded to mirror the heavier bass hammers and lighter treble hammers of an acoustic piano, while structural reinforcements within the action assembly ensure greater stability during fortissimo and staccato passages.

The CN29 digital piano also features Kawai's *Ivory Touch* key surfaces that gently absorb finger moisture to assist the player's performance, while, *let-off* simulation recreates the subtle 'notch' sensation felt when softly playing the keys of a grand piano, satisfying the expectations of the most discerning pianists.

Shigeru Kawai SK-EX and Kawai EX instruments reproduced with Harmonic Imaging sound technology

The CN29 digital piano captures the magnificent tone of Kawai's flagship Shigeru Kawai *SK-EX* full concert grand piano. Widely regarded as the 'premier pianos of Japan', Shigeru Kawai instruments grace the stages of concert halls and musical institutions throughout the world, and are prized for their exceptional tonal clarity. In addition, the CN29 also features the distinctive sound of Kawai's highly acclaimed *EX* concert grand piano, which has frequently been selected by professional pianists in such prestigious events as the Chopin, Tchaikovsky, and Rubinstein international piano competitions, among others.

Both instruments have been carefully recorded, meticulously analysed, and faithfully reproduced with full 88-key sampling using Harmonic Imaging™ sound technology. This unique process accurately recreates the broad dynamic range of the original grand pianos, affording pianists an extraordinary level of expressiveness ranging from the softest pianissimo to the strongest, boldest fortissimo.

Integrated Bluetooth® MIDI connectivity

In addition to standard MIDI jacks for connecting to other instruments, the CN29 digital piano also boasts integrated *Bluetooth MIDI* technology that allows the instrument to communicate with supported smart devices wirelessly. Once connected to a phone, tablet, or laptop, CN29 digital piano owners can enjoy a wide variety of exciting music-related apps that enhance their learning and playing experience without additional cables.

* Availability of Bluetooth function dependent on market location.

Internal Song recorder, Built-in Lesson Function

The CN29 digital piano features a three song recorder, allowing performances to be recorded to internal memory and played back at the touch of a button.

In addition, the convenient lesson feature allows aspiring pianists to learn the piano using a built-in collection of etudes from Czerny and Burgmüller, or songs from the popular Alfred course books. The left and right hand parts for each piece can be practiced separately, while adjusting the tempo allows more difficult passages to be perfected.

2 Owner's Manual Conventions

This owner's manual utilises a number of illustrative conventions in order to explain the CN29 digital piano's various functions. The examples below provide an overview of the button LED indicator states and press types, and the appearance of difference kinds of text.

■ Button LED indicator states



LED indicator off:

Sound/Function is not selected.



LED indicator on:

Sound/Function is selected.



LED indicator flashing:

Sound/Function is selected in a temporary state.

■ Button press types



Normal press:

Select a sound or function.



Press twice:

Select a sound or function.



Press multiple times:

Cycle through sounds or settings.

■ Text appearance

Normal instruction and explanation text is written in regular type at 9 pt. size.

* Notes about functions are marked with an asterisk and written in 8 pt. size.

Reminders about previous operations are written in italic type at 9 pt. size.

- **Captions explaining the display or button functions, are written in bold type at 8.5 pt. size.**

Example operations are written in italic type at 8 pt. size, and enclosed within a grey box.

Part Names and Functions

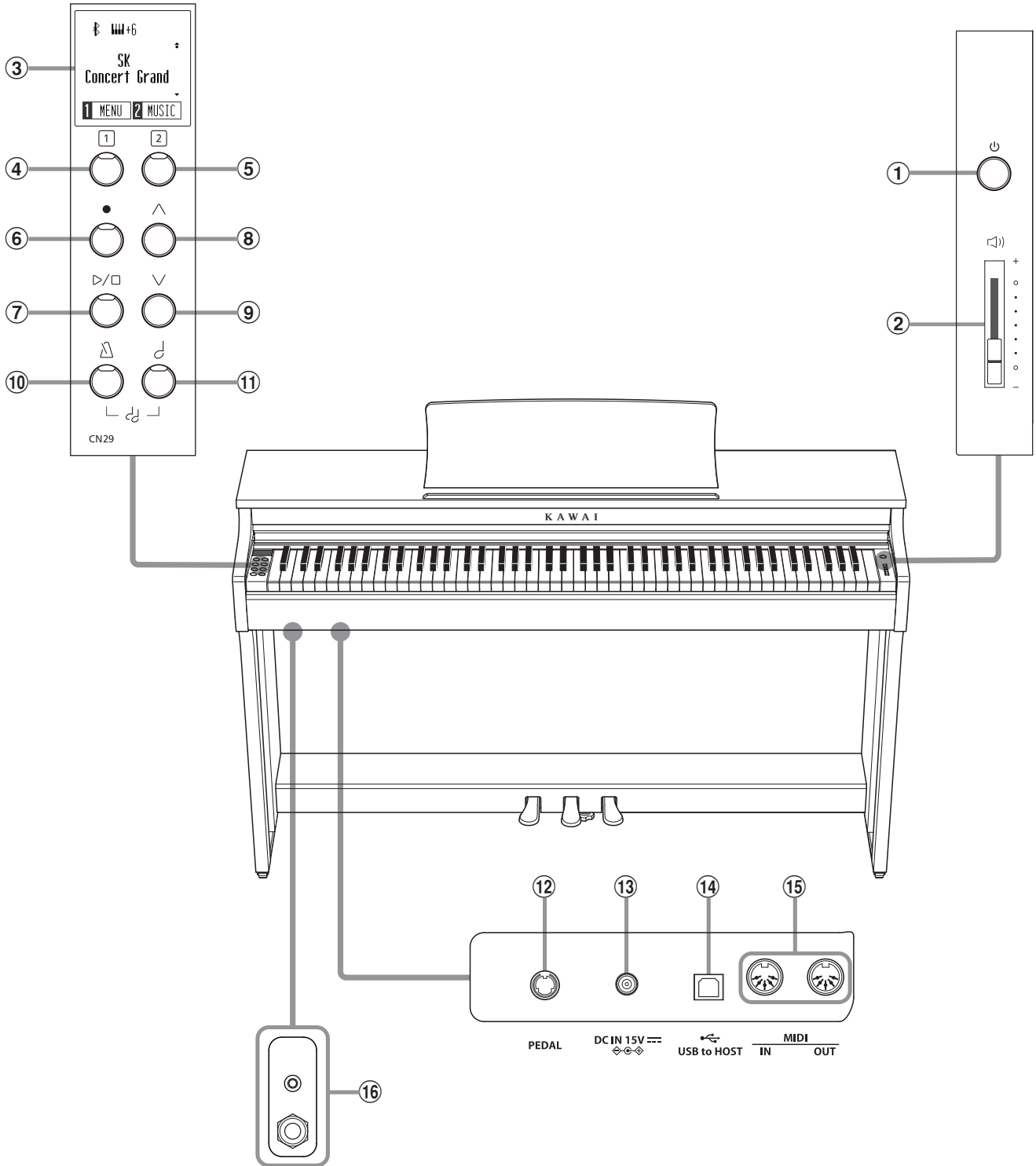

① POWER button

This button is used to turn the CN29 digital piano on/off. Be sure to turn off the instrument after playing.

② MASTER VOLUME slider

This slider controls the master volume level of the CN29 digital piano's built-in speakers or headphones, if connected.

③ OLED Display

The OLED display provides useful information such as the currently selected sound name, settings values, and the status of other functions when active. An example of the main play screen is shown below.

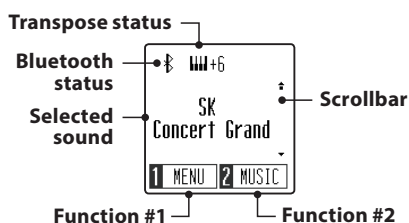

* A protective plastic film is attached to the display during production. Please remove this film before attempting to play the instrument.

④ ⑤ FUNCTION buttons

These buttons are used to select functions/options shown at the bottom of the display. An example is shown below.

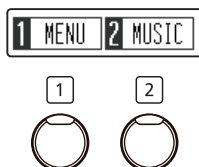
**⑥ REC button**

This button is used to record performances to the CN29 digital piano's internal memory.

⑦ PLAY / STOP button

This button is used to start/stop the playback of Recorder songs stored in memory and CN29 digital piano's built-in Lessons songs.

⑧ ⑨ UP / DOWN button

These buttons are used cycle through sounds, navigate through menus, and adjust values.

⑩ METRONOME button

This button is used to turn the metronome function on/off, and also to adjust its tempo, time signature, and volume settings.

⑪ SOUND SELECT button

This button is used to select the sound(s) that will be heard when the keys are pressed.

Pressing both the [METRONOME] and [SOUND SELECT] buttons simultaneously will activate DUAL mode, allowing two different voices to be played together.

⑫ PEDAL connector

This connector is used to connect the CN29 digital piano's pedal board to the instrument.

⑬ DC IN jack

This jack is used to connect the AC adaptor.

⑭ USB to Host port

This port is use to connect the instrument to a computer using a USB 'B to A' type cable in order to send and receive MIDI data.

⑮ MIDI IN / OUT jacks

These jacks are used to connect the CN29 digital piano to external MIDI devices, such as other musical instruments or a computer, in order to send and receive MIDI data.

⑯ PHONES jacks

These jacks are used to connect stereo headphones to the CN29 digital piano. 1/4" and 1/8" connectors are provided for convenience, and both can be used simultaneously, allowing two pairs of headphones to be connected at the same time.

Setting up the Piano

1 Power

1. Connecting the power adaptor to the instrument

Connect the AC power adaptor to the DC IN terminal located on the underside of the instrument, as indicated below.

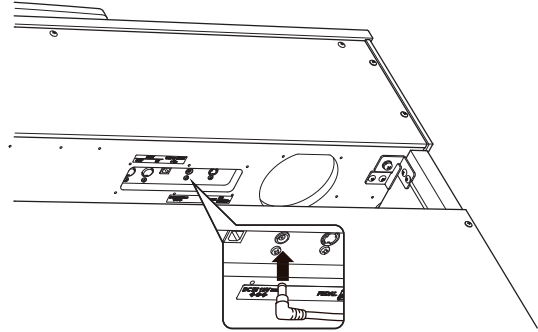

2. Connecting the power adaptor to an outlet

Connect the AC power adaptor to an AC outlet.

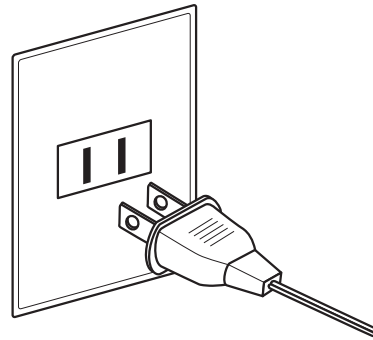

3. Turning on the power

Press the POWER button, located on the right hand side of the instrument's front panel.

The instrument will turn on, and the words 'SK Concert Grand' will be shown in the display, indicating that the SK Concert Grand sound is selected, and the instrument is ready to be played.

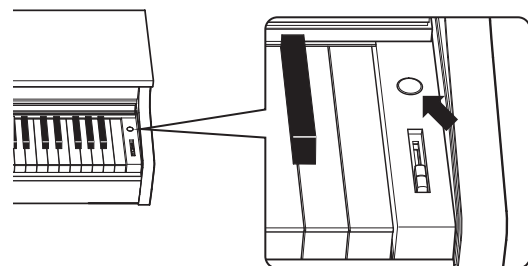

* The CN29 digital piano incorporates power saving features that can turn off the display and the instrument automatically after a specified period of inactivity. For more information, please refer to the 'Auto Display Off' and 'Auto Power Off' settings on pages 49 and 50.

2 Key cover and music rest

■ Opening the key cover

Gently lift the key cover with both hands, then slowly push it back, into the instrument's body.

To close the key cover, slowly pull the handle with both hands, then gently lower it downward.

* Please close the lid slowly in order to avoid injury.

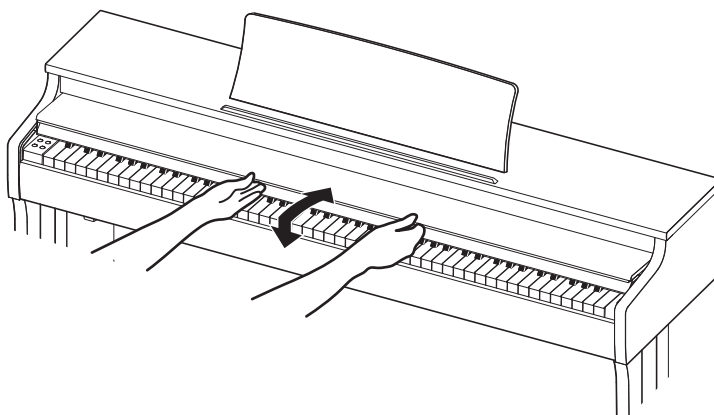

■ Adjusting the music rest

Lift the music rest, then lower the metal prop (rear side) into the recessed holder to set the desired music rest angle.

* The music rest can be set to one of three different angle positions.

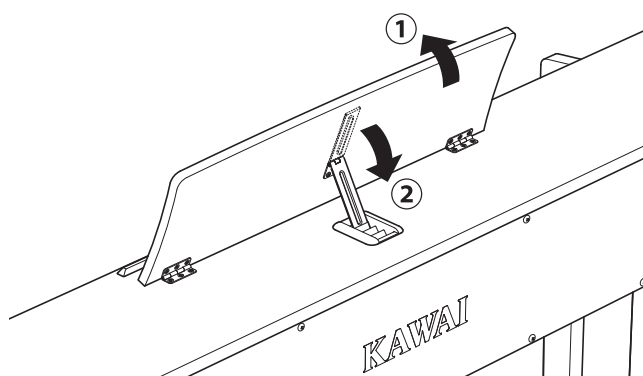
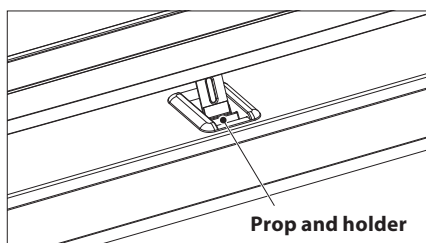

To lower the music rest, gently lift the prop from the recessed holder, then lower the music rest.

* Please lower the music rest slowly in order to avoid injury.

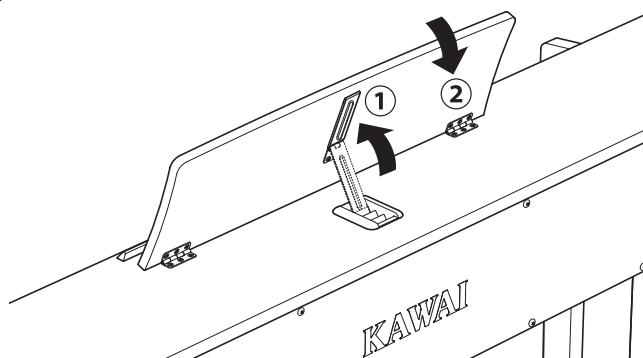

3 Volume and headphones

■ Adjusting the volume

The [MASTER VOLUME] slider controls the volume level of the instrument's speakers, or headphones if connected.

Move the slider up to increase the volume, and down to decrease the volume.

Use this slider to set the volume to a comfortable listening level – the middle is often a good starting point.

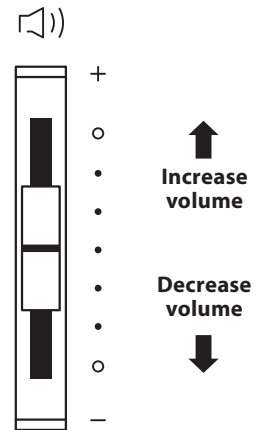

■ Using headphones

Use the jacks located beneath the keyboard on the left hand side, to connect stereo headphones to the CN29 digital piano. 1/4" and 1/8" connectors are provided for convenience.

Two pairs of headphones can be connected and used simultaneously.

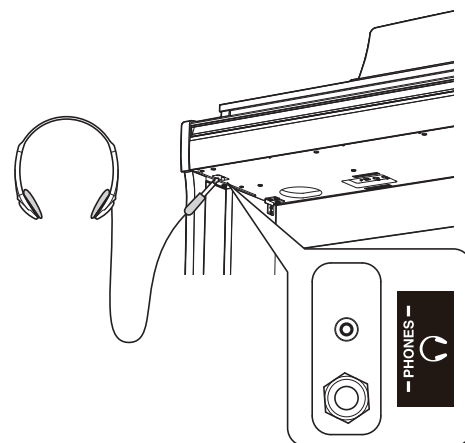

■ Attaching the headphone hook (optional)

A headphone hook is included with the CN29 digital piano and can be used to hang headphones when not in use.

If desired, attach the headphone hook to the underside of the keyboard as shown in the illustration opposite.

* For more information, please refer to the 'Assembly Instructions' on page 58

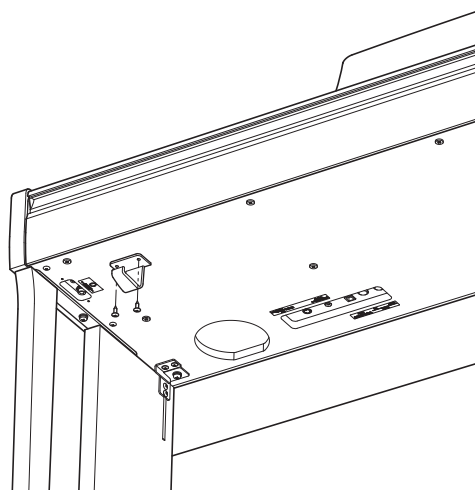

4 Pedals

As with a grand piano, the CN29 digital piano features three pedals: sustain, sostenuto, and soft.

■ Sustain pedal (right pedal)

Depressing this pedal sustains the sound after one's hands have been lifted from the keyboard – greatly enriching the piano sound, while also assisting smooth 'legato' passages.

The sustain pedal is capable of responding to half pedaling.

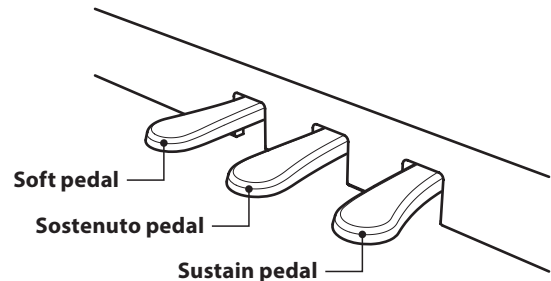

■ Soft pedal (left pedal)

Depressing this pedal softens the sound, reducing its volume.

When the Jazz Organ sound is selected, the soft pedal is also used to alternate the speed of the rotary simulation between 'Slow' and 'Fast' effect modes.

■ Sostenuto pedal (centre pedal)

Depressing this pedal after playing the keyboard and before releasing the keys, sustains the sound of only those notes that have been played. Any keys that are subsequently played after the sostenuto pedal is depressed will not be sustained.

■ Pedal support bolt

A pedal support bolt is attached at the base of the pedal board to aid stability when the pedals are pushed.

Turn the bolt anti-clockwise until it makes contact with the floor and supports the pedals firmly. If the pedal support bolt does not make contact with the floor, the pedal board may become damaged.

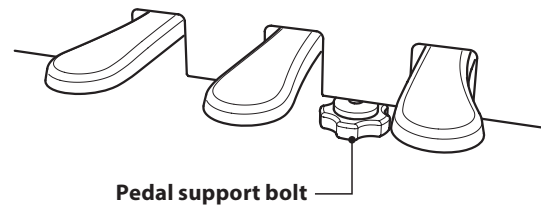

When moving the instrument, always adjust or remove the pedal support bolt, then readjust when the instrument is in its new position.

■ Caring for the pedals

If the surface of the pedals becomes dirty, clean the pedals using a dry dish-washing sponge. Do not attempt to clean the pedals using rust-removing solvents, abrasives or files.

■ Grand Feel Pedal System

The CN29 digital piano features the Grand Feel Pedal System, which replicates the sustain, soft, and sostenuto pedal weighting of a Shigeru Kawai SK Concert Grand piano.

Selecting Sounds

The CN29 digital piano features 19 different instrument sounds, which can be selected in one of two ways. By default the 'SK Concert Grand' sound will be selected automatically when the instrument is turned on.

Available sounds

Acoustic piano sound	Other sounds
SK Concert Grand	Classic E.Piano
EX Concert Grand	Modern E.Piano
Upright Piano	Jazz Organ
Studio Grand	Church Organ
Studio Grand 2	Harpichord
Mellow Grand	Vibraphone
Mellow Grand 2	String Ensemble
Modern Piano	Slow Strings
	Choir
	New Age Pad
	Atmosphere

Selecting a sound: Method 1

Press the [SOUND SELECT] button repeatedly to cycle through the 19 available instrument sounds.

[Power On]



The name of the selected sound will be shown in the display:



Selecting a sound: Method 2

Press the [UP] or [DOWN] buttons to cycle through the 19 available instrument sounds.

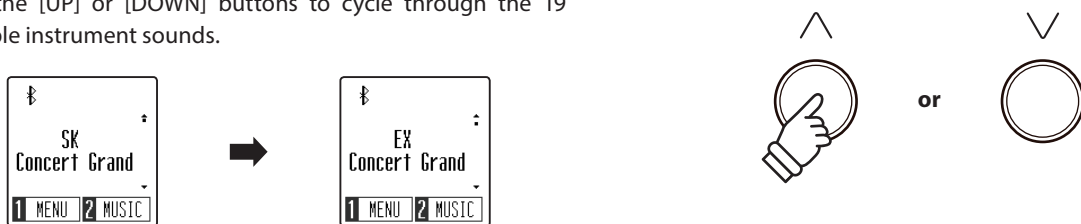

* The preferred sound can be stored to the Startup Setting memory for automatic selection when the instrument is turned on. Please refer to page 51 for more information.

Dual Mode

The Dual Mode function allows two sounds to be layered together, creating a more complex sound. For example, a piano sound layered with strings, or an electric piano combined with a harpsichord etc.

■ Entering Dual Mode

While the normal playing screen is shown in the display:

Press the [METRONOME] and [SOUND SELECT] buttons simultaneously to enable Dual Mode.

The Dual screen will be shown in the display, with the names of the main and layered sounds indicated.

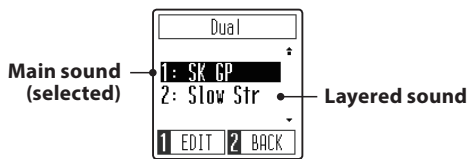
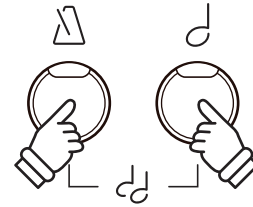

* When Dual Mode is enabled, the Slow Strings sound will automatically be selected as the layered sound.

■ Changing the main/layered sounds

While Dual Mode is enabled:

Press the [SOUND SELECT] button to move the selection cursor over the main or layered sound.



Press the [UP] or [DOWN] buttons to change the assigned sound.

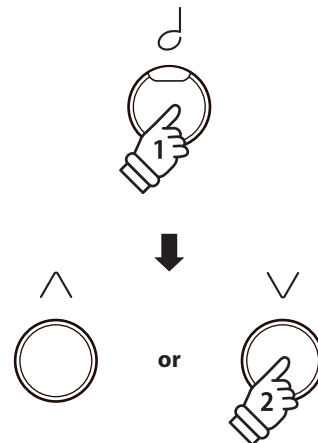

* The preferred Dual Mode sound combination can be stored to the Startup Setting memory for automatic selection when the instrument is turned on. Please refer to page 51 for more information.

■ Adjusting the main/layered sound volume balance

Continued overleaf.

■ Adjusting the main/layered sound volume balance

While Dual Mode is enabled:

Press the [1] function button (EDIT) to show the Dual Mode edit screen.

The right number represents the main sound volume, while the left number represents the layered sound volume.

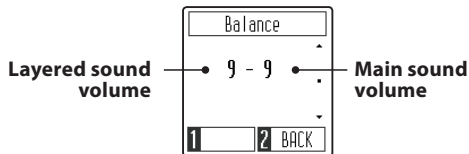

Press the [UP] or [DOWN] buttons to change the volume balance between the main and layered sounds.



* To reset the Dual Mode volume balance to the default value, press the [UP] and [DOWN] buttons simultaneously.

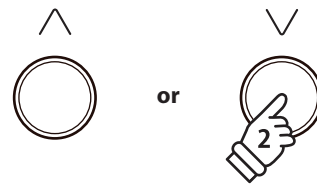

* The preferred Dual Mode volume balance can be stored to the Startup Setting memory for automatic selection when the instrument is turned on. Please refer to page 51 for more information.

■ Exiting Dual Mode

Press the [2] function button (BACK) to exit Dual Mode and return to normal operation.



Four Hands Mode

The Four Hands Mode function divides the keyboard into two sections, with the sustain (right) and soft (left) pedal acting as independent sustain pedals for each section. The octave/pitch of each section is also adjusted, allowing two people to perform piano duets within the same key range using a single instrument.

■ Entering Four Hands Mode

While the normal playing screen is shown in the display:

Press the [1] function button (MENU) to show the Settings menu.

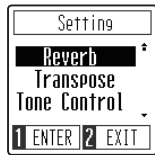

Press the [UP] or [DOWN] buttons to move the selection cursor over the 4Hands function.



Press the [1] function button (ENTER) to enter Four Hands Mode.

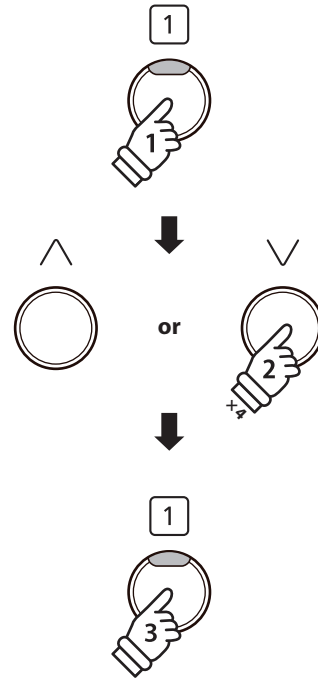

* When Four Hands Mode is enabled, the Split Point dividing the left and right sections is set to key F4, and cannot be changed. In addition, the Recorder function will be disabled.

■ Changing the Four Hands Mode sound

Press the [SOUND SELECT] button or [UP] / [DOWN] buttons to change the selected sound.



* When Four Hands Mode is enabled, the selected sound will be used for both the left and right sections.

■ Exiting Four Hands Mode

While Four Hands Mode is enabled:

Press the [2] function button (BACK) to exit Four Hands Mode and return to the Settings menu, then press the [2] function button (BACK) again to exit the Settings menu and return to normal operation.

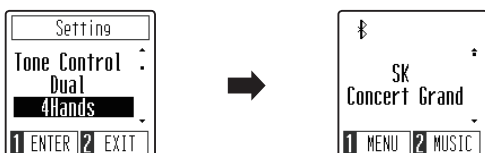

Metronome

The Metronome function provides a steady beat to aid practicing the piano at a consistent tempo. The tempo, time signature, and volume of the metronome can be freely adjusted.

Turning the Metronome on/off

Press the [METRONOME] button.

The LED indicator for the [METRONOME] button will turn on to indicate that the metronome function is in use, and a 4/4 beat will start to count.

The Metronome screen will be shown in the display.



* By default the metronome will count with a 1/4 beat at 120 bpm.

Press the [METRONOME] button again to stop the metronome and return to normal operation.



Adjusting the Metronome tempo

While the Metronome screen is shown in the display:

Press the [UP] or [DOWN] buttons to move the selection cursor over the Tempo setting.

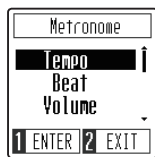

Press the [1] function button (ENTER) to enter the Tempo setting.



Press the [UP] or [DOWN] buttons to adjust the tempo.

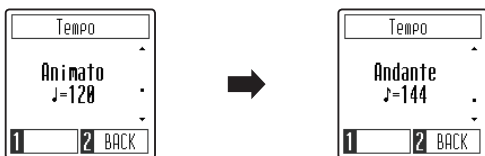

* The metronome tempo can be adjusted within the range of 10~300 bpm.

* The preferred metronome tempo can be stored to the Startup Setting memory for automatic selection when the instrument is turned on. Please refer to page 51 for more information.

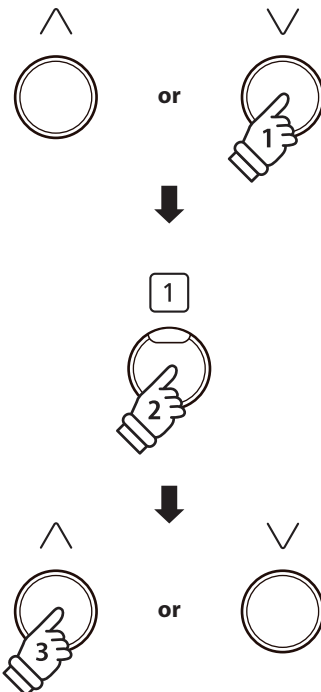

Press the [2] function button (BACK) to exit the Tempo setting screen and return to the metronome screen.

■ Changing the Metronome time signature/beat

While the Metronome screen is shown in the display:

Press the [UP] or [DOWN] buttons to move the selection cursor over the Beat setting.



Press the [1] function button (ENTER) to enter the Beat setting.

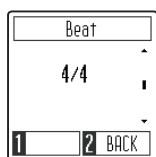

Press the [UP] or [DOWN] buttons to change the time signature.



* The metronome can be set to one of seven time signatures: 1/4, 2/4, 3/4, 4/4, 5/4, 3/8, and 6/8.

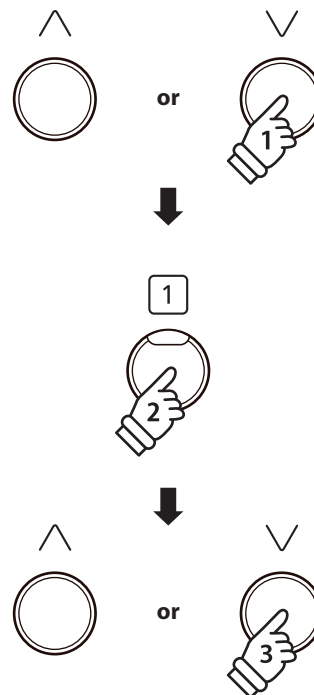

* The preferred metronome time signature can be stored to the Startup Setting memory for automatic selection when the instrument is turned on. Please refer to page 51 for more information.

■ Changing the Metronome volume

While the Metronome screen is shown in the display:

Press the [UP] or [DOWN] buttons to move the selection cursor over the Volume setting.

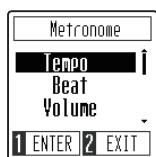

Press the [1] function button (ENTER) to enter the Volume setting.

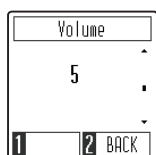

Press the [UP] or [DOWN] buttons to change the volume.



* The metronome volume can be set within the range of 1~10.

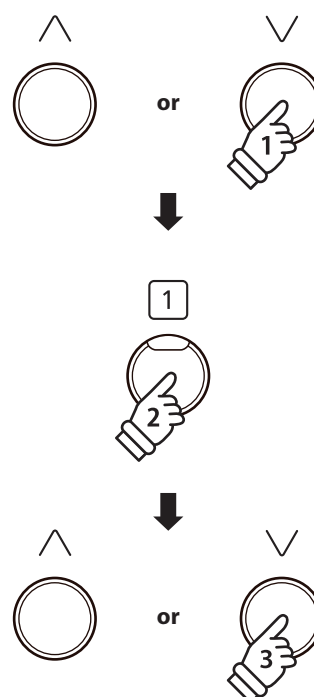

* The preferred metronome volume can be stored to the Startup Setting memory for automatic selection when the instrument is turned on. Please refer to page 51 for more information.

Demo Songs

The CN29 digital piano includes a selection of demonstration songs to introduce each internal sound. For a complete listing of demonstration songs, please refer to page 59 of this owner's manual.

■ Entering Demo Songs mode

While the normal playing screen is shown in the display:

Press the [2] function button (MUSIC) to show the Music menu.

The Demo Songs mode should be pre-selected.



Press the [1] function button (ENTER) to enter Demo Songs mode.

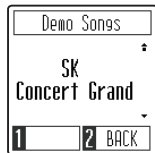

■ Playing/Stopping demo songs

While Demo Songs mode is enabled:

Press the [PLAY/STOP] button.

The demo song for the SK Concert Grand sound will start to play.

* When the SK Concert Grand demo song has finished, another demo song will be selected at random. This process will continue until all of the demo songs have been played.

Press the [PLAY/STOP] button again to stop song playback.



■ Selecting a demo song

While Demo Songs mode is enabled:

Press the [SOUND SELECT] button or [UP] / [DOWN] buttons to change the selected demo song.

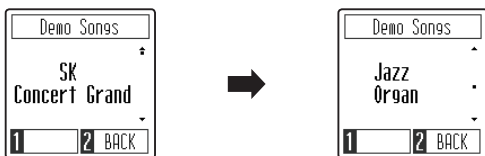

■ Exiting Demo Songs mode

Press the [2] function button (BACK) to exit Demo Songs mode and return to the Music menu, then press the [2] function button (EXIT) again to exit the Music menu and return to normal operation.

Concert Magic

The Concert Magic function allows complete beginners to enjoy playing the piano by simply selecting one of the 40 pre-programmed songs, then tapping the keyboard with a steady rhythm and tempo.

For a complete listing of available Concert Magic songs, please refer to page 59 of this owner's manual.

■ Entering Concert Magic mode

While the normal playing screen is shown in the display:

Press the [2] function button (MUSIC) to show the Music menu.



Press the [UP] or [DOWN] buttons to move the selection cursor over Concert Magic mode.



Press the [1] function button (ENTER) to enter Concert Magic mode.

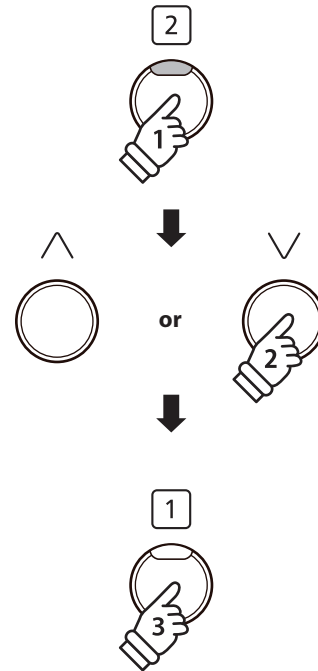

■ Performing a Concert Magic song

While Concert Magic mode is enabled:

Press keys on the keyboard.

The song will advance with every key that is pressed.

Pressing the keys gently will produce a soft sound, while pressing heavily will produce a loud sound.

Similarly, pressing the keys quickly will increase the tempo of the song, while pressing slowly will decrease the tempo.

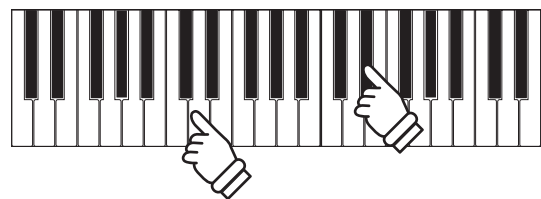

■ Selecting a Concert Magic song

Continued overleaf.

Concert Magic

■ Selecting a Concert Magic song

While Concert Magic mode is enabled:

Press the [UP] or [DOWN] buttons to select the desired Concert Magic song.

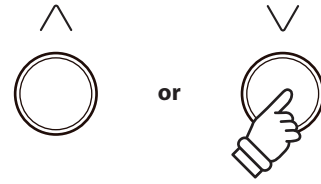

■ Exiting Concert Magic mode

While Concert Magic mode is enabled:

Press the [2] function button (BACK) to exit Concert Magic mode and return to the Music menu, then press the [2] function button (EXIT) again to exit the Music menu and return to normal operation.



Concert Magic song arrangement types

Concert Magic songs are divided into three different arrangement types: Easy Beat (EB), Melody Play (MP), and Skillful (SK). Each arrangement type requires a different level of skill to be performed correctly.

Easy Beat

EB

These are the easiest songs to play. To perform them, simply tap out a constant, steady beat on any key of the keyboard. For example, when playing the piece 'Für Elise', a constant, steady rhythm should be maintained throughout the song.

Key on: X

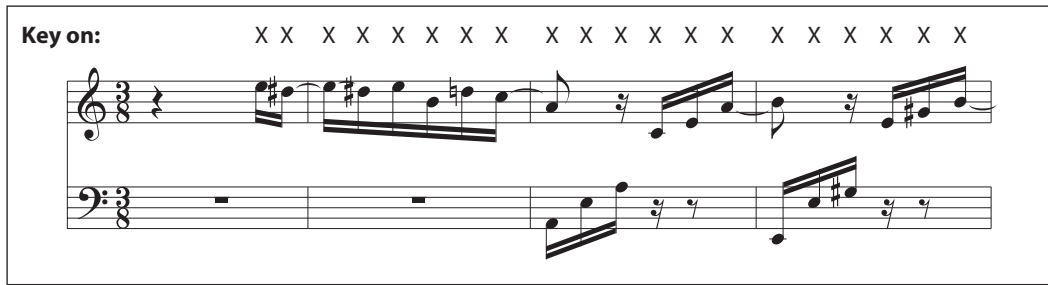

Melody Play

MP

These songs are also relatively easy to play, especially if they are familiar to the player. To perform them, tap out the rhythm of the melody on any key of the keyboard. Singing along as the rhythm is tapped can be helpful.

For example, when playing the piece 'Twinkle, Twinkle, Little Star', the rhythm of the melody should be played.

* When performing fast Concert Magic songs, it may be easier to press different keys with two alternating fingers in order to achieve greater speed.

Key on: X X X X X X X X X X X X X X X



Skillful

SK

These songs range in difficulty from moderately difficult to difficult. To perform them, tap out the rhythm of both the melody and the accompaniment notes on any key of the keyboard.

For example, when playing the piece 'Waltz of the Flowers', the rhythm of both the melody and the accompaniment should be played.

Key on: X X X X X X X X X X X X X X X



Concert Magic playing mode

The Concert Magic playing mode setting changes the Concert Magic playing mode, allowing all Concert Magic songs to be played by simply tapping any key with a constant steady beat, regardless of the song arrangement type.

Concert Magic playing mode

Concert Magic playing mode	Description
Normal (default)	Concert Magic songs will be performed according to their arrangement type.
Steady Beat	All Concert Magic songs will be performed by tapping the key with a constant beat.

Changing the Concert Magic playing mode

While Concert Magic mode is enabled:

Press the [1] function button (EDIT) to enter the Concert Magic edit screen.

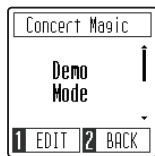

Press the [UP] or [DOWN] buttons to select the Playing Mode setting.



Press the [1] function button to enter the Playing Mode setting screen.

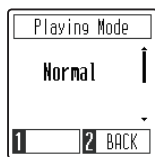

Press the [UP] or [DOWN] buttons to change the Playing Mode.

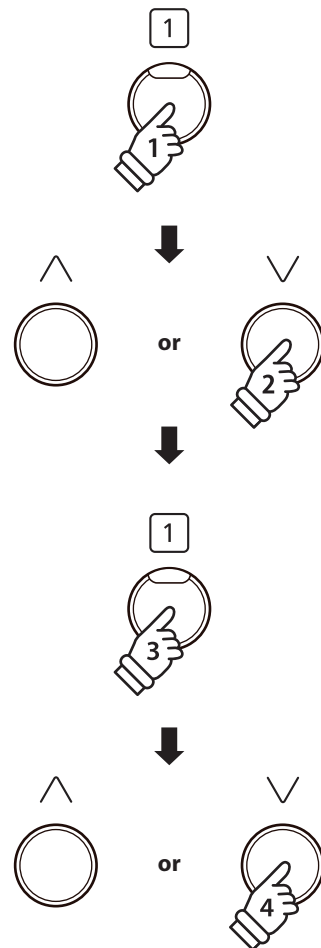

Concert Magic demo mode

The Concert Magic demo mode allows Concert Magic songs to be listened to without pressing the keys. There are four playback methods: All Play, Category Play, Repeat Play, and Random Play.

■ Concert Magic demo mode

Concert Magic demo mode	Description
All Play	Play the selected Concert Magic song, then play the rest of the songs in numerical order.
Category Play	Play the selected Concert Magic song, then play the rest of the songs in the same category.
Repeat Play (default)	Play the selected Concert Magic song repeatedly.
Random Play	Play the selected Concert Magic song, then play the rest of the songs in random order.

■ Playing/Stopping Concert Magic songs

While Concert Magic mode is enabled:

Press the [PLAY/STOP] button.

The selected Concert Magic song will start to play.

* By default, the selected song will play repeatedly until it is stopped. This behaviour can be changed using the Playing Mode setting.

Press the [PLAY/STOP] button again to stop song playback.



■ Changing the Concert Magic demo mode

While Concert Magic mode is enabled:

Press the [1] function button (EDIT) to enter the Concert Magic edit screen. The Demo Mode setting should be pre-selected.

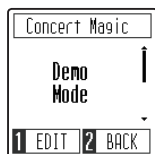

Press the [1] function button (ENTER) to enter the Demo Mode setting screen.

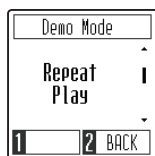

Press the [UP] or [DOWN] buttons to change the Demo Mode.

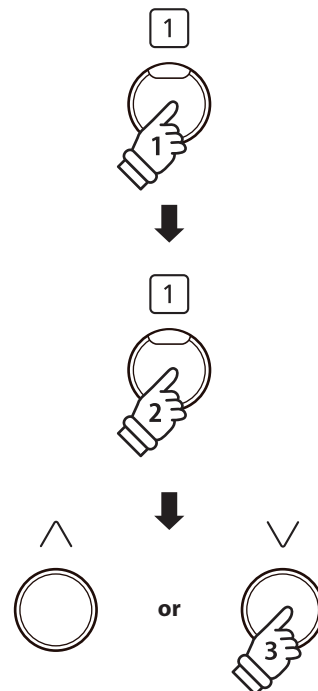
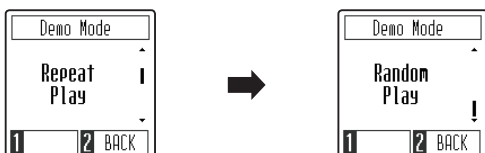

Lesson Function

The Lesson function allows budding pianists to practice the piano using a selection of built-in song books. The left and right hand parts for each piece can be practiced separately, while adjusting the tempo allows difficult passages to be perfected.

For a complete listing of available Lesson Function songs, please refer to page 60 of this owner's manual.

Built-in lesson function song books

	US, Canada, Australasia	Rest of the World
Book 1	Alfred's Basic Piano Library Lesson Book Level 1A	Beyer 106 (Vorschule im Klavierspiel, Opus 101)
Book 2	Alfred's Basic Piano Library Lesson Book Level 1B	Burgmüller 25 (25 Etudes Faciles, Opus 100)
Book 3	Beyer 106 (Vorschule im Klavierspiel, Opus 101)	Czerny 30 (Etudes de Mécanisme, Opus 849)
Book 4	Burgmüller 25 (25 Etudes Faciles, Opus 100)	Chopin Walzer (Chopin waltzes series 1-19)
Book 5	Czerny 30 (Etudes de Mécanisme, Opus 849)	Alfred's Basic Piano Library Lesson Book Level 1A
Book 6	Chopin Walzer (Chopin waltzes series 1-19)	Alfred's Basic Piano Library Lesson Book Level 1B

* Lesson books sold separately - please refer to page 61 of this owner's manual for more information.

1 Selecting a lesson book and song

Entering Lesson mode

While the normal playing screen is shown in the display:

Press the [2] function button (MUSIC) to show the Music menu.



Press the [UP] or [DOWN] buttons to move the selection cursor over Lesson mode.



Press the [1] function button (ENTER) to enter Lesson mode and show the Lesson book selection screen.

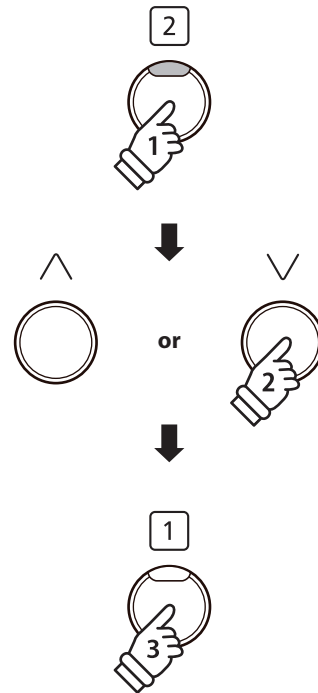
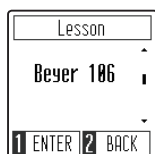

■ Selecting a Lesson book and song

While Lesson mode is enabled:

Press the [UP] or [DOWN] buttons to select the desired Lesson book.



Press the [1] function button (ENTER) to confirm the selected Lesson book.

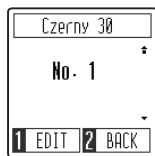

Press the [UP] or [DOWN] buttons to select the desired Lesson song.



* The Beyer lesson book includes 106 exercises. Exercise no.1 consists of 12 variations, while exercise no.2 consists of 8 variations.

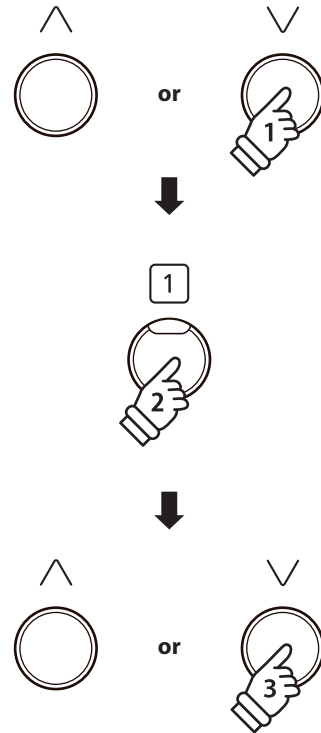

2 Listening to the selected lesson song

This section will explain how to play and stop the selected lesson song, and adjust the tempo.

■ Playing the lesson song

After selecting a lesson book and song:

Press the [PLAY/STOP] button.

A one bar count-in will be heard, then the selected Lesson song will start to play.

* The metronome time signature and tempo will automatically be set to that of the currently selected lesson song.

* By default, the both the left hand and right hand parts of the lesson song will play. This behaviour can be changed using the Part Mode setting.

Press the [PLAY/STOP] button again to stop song playback.



■ Adjusting the tempo of the lesson song

After selecting a lesson book and song:

Press the [METRONOME] button.

The metronome will start to count, and the current tempo will be shown in the display.

* If the lesson song is not playing, the metronome will not count.



Press the [UP] or [DOWN] buttons to adjust the tempo.



or



* The metronome tempo can be adjusted within the range of 10~300 bpm.

* To restore the metronome tempo to the original tempo, press the [UP] and [DOWN] buttons simultaneously.

Press the [METRONOME] button again to stop the metronome and return to the Lesson song screen.

* To return to the Lesson song screen without stopping the metronome, press the [2] function button (BACK).



or



3 Practicing left and right-hand parts separately

This section will explain how to mute/activate the left and right-hand parts of the selected lesson song, allowing each part to be practiced separately.

■ Changing the lesson part mode

After selecting a lesson book and song:

Press the [1] function button (EDIT) to enter the Lesson Part Mode setting screen.

By default, both the left hand and right hand parts will be set to play.



Press the [UP] or [DOWN] buttons to change the Part Mode setting.



* To practise the left hand part, set the part mode setting to Right (i.e. play right hand only). To practise the right hand part, set the part mode setting to Left (i.e. play left hand only).

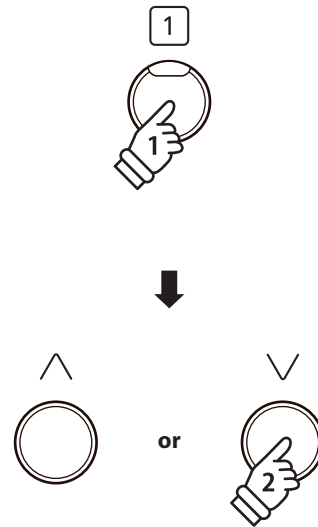

■ Exiting the part mode setting

While the lesson part mode setting screen is shown in the display:

Press the [2] function button (BACK) to exit the lesson part mode setting screen and return to the Lesson song screen.



Recorder

The CN29 digital piano allows up to 3 different songs to be recorded, stored in internal memory, and played back at the touch of a button.

1 Recording a song

1. Entering song recorder mode

While the normal playing screen is shown in the display:

Press the [REC] button.

The LED indicator for the [REC] button will start to flash, to indicate that the piano is in recording standby mode, and the Recorder screen will be shown in the display.



2. Selecting a song memory

Press the [UP] or [DOWN] buttons to select the desired Recorder song memory to record to.



Song has been recorded to

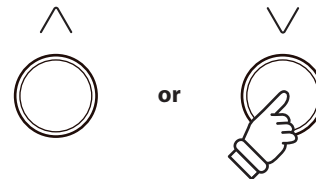

* If a Recorder song memory has already been recorded to, a * symbol will be shown. If this song memory is recorded to again, the previously recorded song will be erased.

3. Starting and stopping the song recorder

Press a key on the keyboard.

The LED indicators for the [PLAY/STOP] and [REC] buttons will turn on, and recording will start.

* Recording can also be started by pressing the [PLAY/STOP] button, allowing a rest period or empty bar to be inserted at the beginning of the song.

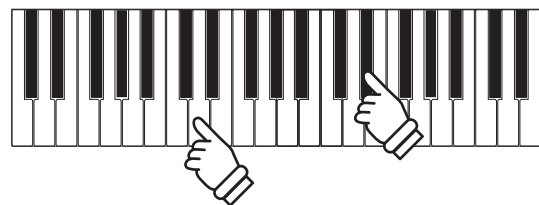

4. Stopping the song recorder

Press the [PLAY/STOP] button.

The LED indicators for the [PLAY/STOP] and [REC] buttons will turn off and the recorder song will be stored to internal memory.

* The maximum recording capacity is approximately 10,000 notes.

* Recorder songs will remain in memory after the power is turned off.



2 Playing back a song

1. Entering song playback mode

While the normal playing screen is shown in the display:

Press the [PLAY/STOP] button.

The LED indicator for the [PLAY/STOP] button will turn on, and the Recorder screen will be shown in the display.

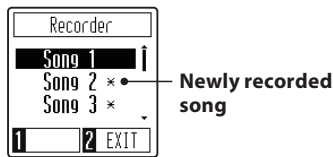

If the selected song memory has already been recorded to, song playback will start automatically.

2. Selecting a song memory

Press the [UP] or [DOWN] buttons to select the desired Recorder song memory to play.

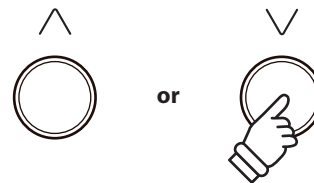

3. Exiting song playback mode

Press the [2] function button (EXIT) to exit the Recorder screen and return to normal operation.



■ Adjusting the playback tempo of the song

While the recorder screen is shown in the display:

Press the [METRONOME] button to show the tempo adjustment screen, then press the [UP] or [DOWN] buttons to adjust the tempo.

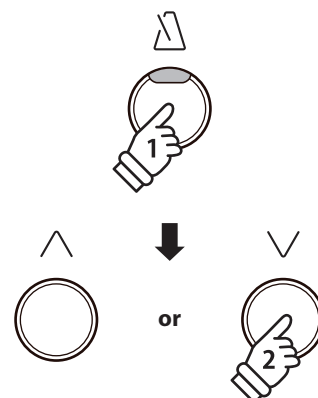

3 Deleting a song

1. Selecting a song memory

While the recorder screen is shown in the display:

Press the [UP] or [DOWN] buttons to select the desired Recorder song memory to delete.

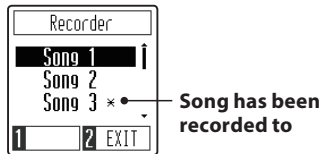
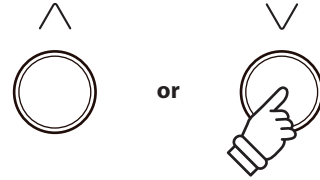

* If a Recorder song memory has already been recorded to, a * symbol will be shown.

2. Deleting the selected song

Press the [1] function button (DELETE).

A confirmation message will be shown in the display, prompting to confirm or cancel the delete operation.

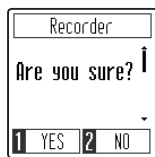

Press the [1] function button (YES) to confirm the delete operation, or the [2] function button (NO) to cancel.

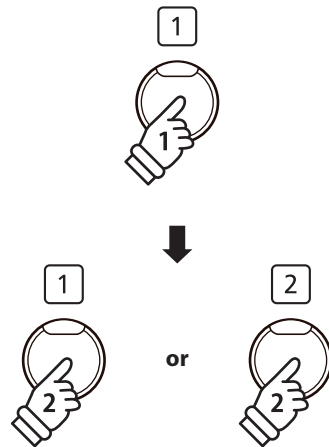

Settings Menu

The Settings menu allow various aspects of the CN29 digital piano to be adjusted. Once adjusted, preferred settings can be stored to the Startup Setting memory for automatic selection when the instrument is turned on.

■ Settings menu

Setting name	Description	Default setting
Reverb	Change the type of reverberation added to the sound.	On
Transpose	Increase or decrease the pitch of the keyboard in semi-tone steps.	0
Tone Control	Change the EQ settings of the instrument's sound.	Flat
Dual	Select the 'Dual Mode' function.	-
Four Hands	Select the 'Split Mode' function.	-
Tuning	Increase or decrease the pitch of the keyboard in 0.5 Hz steps.	440.0 Hz
Touch	Change the touch sensitivity of the keyboard.	Normal
Smart Mode	Change various characteristics of the piano sound.	Normal
Damper Noise	Adjust the volume of the damper noise sound.	5
Key Volume	Adjust the volume of individual keys.	Off
Spatial Headphone Sound	Select the desired Spatial Headphone Sound mode.	Normal
Phones Type	Select the type of headphones to be used with the instrument.	Normal
Bluetooth MIDI	Enable/disable the instrument's Bluetooth MIDI function.	On
MIDI Settings *	Change various MIDI settings	-
Auto Display Off	Enable/disable the display's Auto Display Off function.	5 min
Auto Power Off	Enable/disable the instrument's Auto Power Off energy saving function.	-
Startup Setting	Store current settings as the default (power-on) configuration.	-
Factory Reset	Restore all settings to the original factory configuration.	-

* For information regarding MIDI functions and settings, please download the supplementary PDF manual from the Kawai Global website: <http://www.kawai-global.com/support/manual/>

■ Entering the settings menu, selecting a setting

While the normal playing mode screen is shown in the display:

Press the [1] function button (MENU) to show the Settings menu.



Press the [UP] or [DOWN] buttons to move the selection cursor over the desired setting.

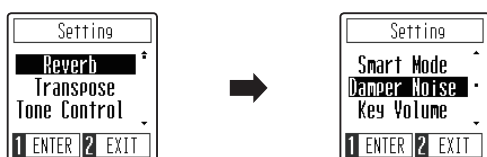

Press the [1] function button (ENTER) to enter the desired setting.

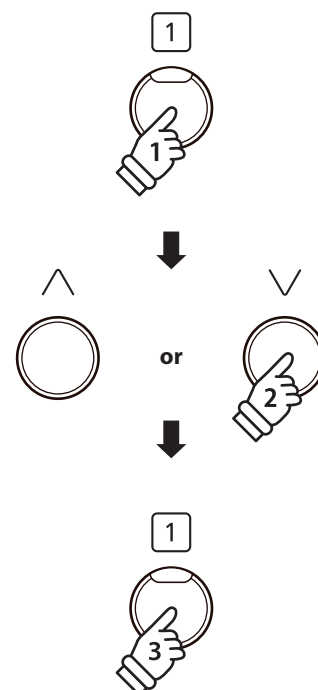

1 Reverb

The Reverb setting adds reverberation to the sound, simulating the acoustic environment of a recital room, stage, or concert hall. The most suitable reverb type is applied automatically when selecting each sound, however it is also possible to select a different reverb type manually if desired.

■ Reverb type

Reverb type	Description
Off	Disables the reverb effect.
Room	Simulates the ambience of a small rehearsal room.
Lounge	Simulates the ambience of piano lounge.
Small Hall	Simulates the ambience of a small hall.
Concert Hall	Simulates the ambience of a concert hall or theater.
Live Hall	Simulates the ambience of a live hall or stage.
Cathedral	Simulates the ambience of a large cathedral.

1. Changing the Reverb setting

After entering the Reverb setting:

Press the [UP] or [DOWN] buttons to select the desired Reverb type.

* The preferred Reverb type setting can be stored to the Startup Setting memory for automatic selection when the instrument is turned on. Please refer to page 51 for more information.

* To reset this setting to the default value, press the [UP] and [DOWN] buttons simultaneously.



2 Exiting the Reverb setting

Press the [2] function button (BACK) to exit the Reverb setting and return to the Settings menu.



2 Transpose

The Transpose setting allows the pitch of the CN29 digital piano keyboard to be raised or lowered in semi-tone steps. This is particularly useful when accompanying instruments with different tones, or when a song learned in one key must be played in another key. When transposed, the song can be played in the original key, yet heard in a different key.

1. Adjusting the Transpose setting

After entering the Transpose setting:

Press the [UP] or [DOWN] buttons to increase or decrease the value of the Transpose setting.

* The Transpose setting can be adjusted within the range of -12~+12 semi-tones.

* The preferred Transpose setting can be stored to the Startup Setting memory for automatic selection when the instrument is turned on. Please refer to page 51 for more information.

* To reset this setting to the default value, press the [UP] and [DOWN] buttons simultaneously.

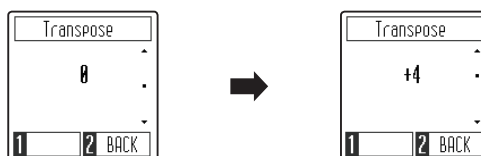

2 Exiting the Transpose setting

Press the [2] function button (BACK) to exit the Transpose setting and return to the Settings menu.

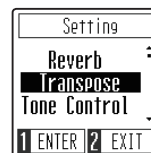

3 Tone Control

The Tone Control setting allows the overall sound character of the CN29 digital piano to be adjusted to provide the best sound quality within the area that the instrument is located. There are eight different preset EQ settings available, including an adjustable Brilliance tone control type.

■ Tone Control setting

Tone Control type	Description
Flat (default)	Tone control adjustment is not applied.
Brilliance	Adjusts the overall brightness of the sound, independently of the Virtual Technician 'Voicing' parameter.
Bass Boost	Emphasises low-range frequencies, creating a deeper sound.
Bass Cut	Reduces low-range frequencies, creating a clearer sound.
Mid Boost	Emphasises mid-range frequencies, creating a harder sound.
Loudness	Emphasises frequencies to retain the instrument's sound character when playing at low volume levels.
Bright	Emphasises high-range frequencies, creating a brighter sound.
Mellow	Reduces high-range frequencies, creating a softer sound.

1. Changing the Tone Control setting

After entering the Tone Control setting:

Press the [UP] or [DOWN] buttons to select the desired Tone Control type.

* The preferred Tone Control type setting can be stored to the Startup Setting memory for automatic selection when the instrument is turned on. Please refer to page 51 for more information.

* To reset this setting to the default value, press the [UP] and [DOWN] buttons simultaneously.

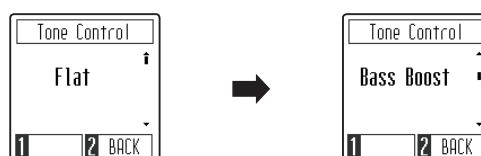

2 Exiting the Tone Control setting

Press the [2] function button (BACK) to exit the Tone Control setting and return to the Settings menu.



■ Adjusting the Brilliance value

After selecting the Brilliance tone control type:

Press the [1] function button (EDIT) to enter the Brilliance tone control setting.

Press the [UP] or [DOWN] buttons to increase or decrease the value of the Brilliance tone control setting.

* The Brilliance tone control setting can be adjusted within the range of -10~+10.

* To reset this setting to the default value, press the [UP] and [DOWN] buttons simultaneously.



4 Dual / 5 Four Hands

Please refer to pages 19 and 21 for information regarding the Dual and Four Hands mode functions.

6 Tuning

The Tuning setting allows the overall pitch of the CN29 digital piano to be raised and lowered in 0.5 Hz steps, and may therefore prove useful when playing with other instruments.

1. Adjusting the Tuning setting

After entering the Tuning setting:

Press the [UP] or [DOWN] buttons to increase or decrease the value of the Tuning setting.

- * The Tuning setting can be adjusted within the range of 427~453 Hz.
- * The preferred Tuning setting can be stored to the Startup Setting memory for automatic selection when the instrument is turned on. Please refer to page 51 for more information.
- * To reset this setting to the default value, press the [UP] and [DOWN] buttons simultaneously.

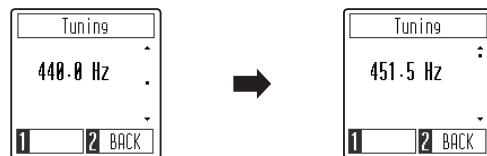

2 Exiting the Tuning setting

Press the [2] function button (BACK) to exit the Tuning setting and return to the Settings menu.

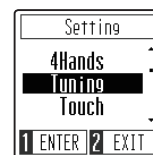

7 Touch

As with an acoustic piano, the CN29 digital piano produces a louder sound when the keys are struck with force, and a softer sound when the keys are played gently. The volume and tonal character change in relation to the strength and speed of playing - on a digital piano this system is referred to as 'touch sensitivity'.

The Touch setting allows the touch sensitivity of the keyboard to be conveniently adjusted. There are four different preset touch settings available.

■ Touch type

Touch type	Description
Light	A louder volume is produced even when playing with a soft touch. This setting is recommended for children and organ players, or for those still developing finger strength.
Normal (default)	Reproduces the standard touch sensitivity of an acoustic piano.
Heavy	Requires a heavier touch to produce a loud volume. This setting is recommended to those with stronger fingers.
Off	A constant volume is produced regardless of how hard the keys are struck. This setting is recommended for sounds that have a fixed dynamic range such as organ and harpsichord.

1. Changing the Touch setting

After entering the Touch setting:

Press the [UP] or [DOWN] buttons to select the desired Touch type.

* The preferred Touch type setting can be stored to the Startup Setting memory for automatic selection when the instrument is turned on. Please refer to page 51 for more information.

* To reset this setting to the default value, press the [UP] and [DOWN] buttons simultaneously.

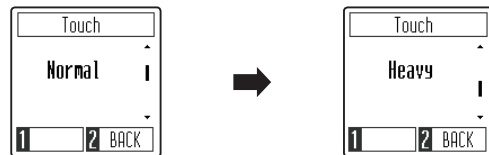

2 Exiting the Touch setting

Press the [2] function button (BACK) to exit the Touch setting and return to the Settings menu.

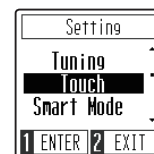

8 Smart Mode Virtual Technician

An experienced piano technician is essential to fully realise the potential of a fine acoustic piano. In addition to meticulously tuning each note, the technician also performs numerous regulation and voicing adjustments that allow the instrument to truly sing.

The CN29 digital piano's Smart Mode Virtual Technician simulates these refinements digitally, with ten preset configurations that adjust various characteristics of the grand piano sound to match different musical styles.

Virtual Technician type

Virtual Technician type	Description
Normal (default)	The default piano sound without additional adjustments.
Noiseless	A piano adjusted to minimise additional damper and string resonances, and mechanism noises.
Deep Resonance	A piano adjusted to emphasise damper and string resonances.
Light Resonance	A piano adjusted to reduce damper and string resonances.
Soft	A piano adjusted by softening the hammers and increasing the touch weight of the keyboard in order to produce a softer tone that is suitable for slow, quiet pieces.
Brilliant	A piano adjusted by hardening the hammers in order to produce a brighter tone for modern pieces.
Clean	A piano adjusted by hardening the hammers and reducing the damper and string resonances.
Full	A piano adjusted to emphasise dynamics with a lightened keyboard touch and powerful damper and string resonances.
Dark	A piano adjusted by hardening the hammers and increasing the touch weight of the keyboard, in order to produce a dark, gloomy tone.
Rich	A piano adjusted by lightening the touch weight of the keyboard and increasing damper and string resonances.
Historical	A piano adjusted for romantic, classical music, with a bright, open tone.

1. Changing the Virtual Technician setting

After entering the Virtual Technician setting:

Press the [UP] or [DOWN] buttons to select the desired Virtual Technician type.

* The preferred Virtual Technician type setting can be stored to the Startup Setting memory for automatic selection when the instrument is turned on. Please refer to page 51 for more information.

* To reset this setting to the default value, press the [UP] and [DOWN] buttons simultaneously.

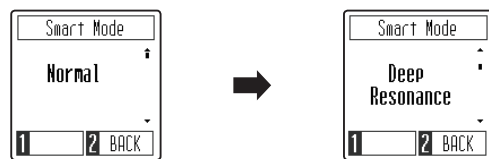

2 Exiting the Virtual Technician setting

Press the [2] function button (BACK) to exit the Virtual Technician setting and return to the Settings menu.

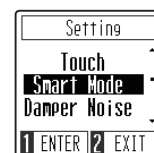

9 Damper Noise

When the damper pedal of an acoustic piano is pressed and released, it is often possible to hear the sound of the damper head touching and releasing the strings.

The CN29 digital piano reproduces this sound, with the Damper Noise setting allowing the volume of this sound to be adjusted. The speed at which the damper pedal is pressed will also influence the prominence of the damper noise, with fast pedalling creating a very pronounced sound.

1. Adjusting the Damper Noise setting

After entering the Damper Noise setting:

Press the [UP] or [DOWN] buttons to increase or decrease the value of the Damper Noise setting.

* The Damper Noise setting can be adjusted within the range of 0~10.

* The preferred Damper Noise setting can be stored to the Startup Setting memory for automatic selection when the instrument is turned on. Please refer to page 51 for more information.

* To reset this setting to the default value, press the [UP] and [DOWN] buttons simultaneously.



2 Exiting the Damper Noise setting

Press the [2] function button (BACK) to exit the Damper Noise setting and return to the Settings menu.



10 Key Volume

The Key Volume settings allow the volume of each of the 88-keys to be adjusted individually.

■ Key Volume setting

Key Volume	Description
Off (default)	Disables 88-key volume adjustment.
On	Enables 88-key volume adjustment.

1. Changing the Key Volume setting

After entering the Key Volume setting:

Press the [UP] or [DOWN] buttons to turn Key Volume adjustment on or off.

* The preferred Key Volume setting can be stored to the Startup Setting memory for automatic selection when the instrument is turned on. Please refer to page 51 for more information.

* To reset this setting to the default value, press the [UP] and [DOWN] buttons simultaneously.



2 Exiting the Key Volume setting

Press the [2] function button (BACK) to exit the Key Volume setting and return to the Settings menu.



■ Adjusting the volume of individual keys

After entering the Key Volume setting:

Press the [1] function button (EDIT) to enter the Key Volume adjustment screen.

Press the desired key to be adjusted.

The name of the key will be shown in the display.

Press the [UP] or [DOWN] buttons to increase or decrease the volume of the selected key.

* The volume of each key can be adjusted within the range of -50~+50.

* The volume of each key will be stored automatically, and recalled every time the instrument is turned on.

* To reset the volume of a key to the default value, press the [UP] and [DOWN] buttons simultaneously.

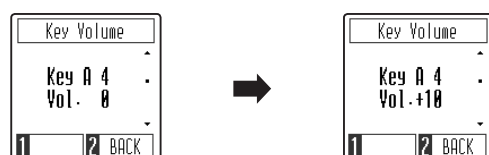
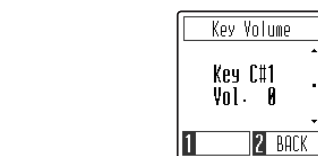

11 Spatial Headphone Sound

Spatial Headphone Sound is a special feature of the CN29 digital piano that enhances the depth and realism of the acoustic piano sound when listening through headphones or earphones.

The Spatial Headphone Sound setting allows the player to select from one of three different acoustic presets that adjust the spatial positioning of the sound, while also helping to reduce auditory fatigue when using earphones or headphones for extended periods of time.

■ Spatial Headphone Sound type

Spatial Headphone Sound type	Description
Off	Disable the Spatial Headphone Sound feature.
Forward	Front focused, somewhat narrow spatial positioning.
Normal (default)	Naturally balanced spatial positioning that is neither forward nor wide.
Wide	Wide, very open spatial positioning.

1. Changing the Spatial Headphone Sound setting

After entering the Spatial Headphone Sound setting:

Press the [UP] or [DOWN] buttons to select the desired Spatial Headphone Sound type.

* The preferred Spatial Headphone Sound type setting can be stored to the Startup Setting memory for automatic selection when the instrument is turned on. Please refer to page 51 for more information.

* To reset this setting to the default value, press the [UP] and [DOWN] buttons simultaneously.

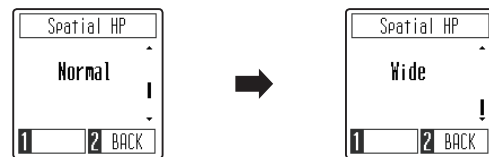

2 Exiting the Spatial Headphone Sound setting

Press the [2] function button (BACK) to exit the Spatial Headphone Sound setting and return to the Settings menu.



12 Phones Type

The Phones Type setting optimises the sound of the CN29 digital piano when listening through different types of headphones or earphones.

* This setting does not affect the speaker sound.

■ Phones type

Phones type	Description
Normal (default)	Disables headphone optimisation.
Open	Optimises the sound for open type headphones.
Semi-open	Optimises the sound for semi-open type headphones.
Closed	Optimises the sound for closed type headphones.
Inner-ear	Optimises the sound for inner-ear type headphones.
Canal	Optimises the sound for canal-type headphones

1. Changing the Phones Type setting

After entering the Phones Type setting:

Press the [UP] or [DOWN] buttons to select the desired Phones type.

* The preferred Phones Type setting can be stored to the Startup Setting memory for automatic selection when the instrument is turned on. Please refer to page 51 for more information.

* To reset this setting to the default value, press the [UP] and [DOWN] buttons simultaneously.



2 Exiting the Phones Type setting

Press the [2] function button (BACK) to exit the Phones Type setting and return to the Settings menu.



13 Bluetooth MIDI

The Bluetooth MIDI setting is used to enable/disable the CN29 digital piano's Bluetooth MIDI function. When enabled, the CN29 digital piano can be connected to smart phones, tablets, and other smart devices to facilitate wireless MIDI communication, allowing a wide range of music-related apps to be enjoyed using the instrument.

* Availability of Bluetooth function dependent on market location.

■ Bluetooth MIDI setting

Bluetooth MIDI	Description
Off	Disables the instrument's Bluetooth MIDI function.
On (default)	Enables the instrument's Bluetooth MIDI function.

1. Changing the Bluetooth MIDI setting

After entering the Bluetooth MIDI setting:

Press the [UP] or [DOWN] buttons to turn Bluetooth MIDI on or off.

* The preferred Bluetooth MIDI setting can be stored to the Startup Setting memory for automatic selection when the instrument is turned on. Please refer to page 51 for more information.

* To reset this setting to the default value, press the [UP] and [DOWN] buttons simultaneously.

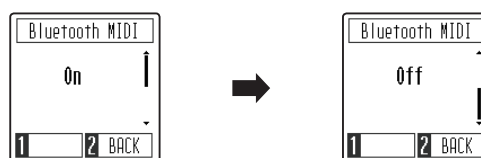

2 Exiting the Bluetooth MIDI setting

Press the [2] function button (BACK) to exit the Bluetooth MIDI setting and return to the Settings menu.



■ Connecting the CN29 digital piano to a smart device using Bluetooth MIDI

After enabling the Bluetooth MIDI function of the CN29 digital piano, enable Bluetooth communications on the smart device, then open the desired MIDI app. After a few seconds 'CN29' should appear in the app's device list. Tap the 'CN29' entry to connect the instrument to the smart device. The Bluetooth icon shown in the LCD will become highlighted to indicate that a connection has been established, allowing MIDI apps to communicate wirelessly with the CN29 digital piano.

* When the CN29 digital piano is connected to a smart device via Bluetooth MIDI, the USB MIDI and MIDI IN/OUT connectors will be disabled.

* Please check for Bluetooth MIDI compatibility with the smart device manufacturer and app developer.

* For a list of potential issues and recommended solutions when using Bluetooth communications, please refer to page 54 of this owner's manual.

* For more detailed instructions regarding Bluetooth pairing, please refer to the supplementary Bluetooth® Connectivity Guide manual, available from the Kawai Global website: <http://www.kawai-global.com/support/manual>

14 MIDI Settings

This sub-menu contains various functions and settings related to MIDI.

* For information regarding MIDI functions and settings, please download the supplementary PDF manual from the Kawai Global website:
<http://www.kawai-global.com/support/manual>

15 Auto Display Off

The Auto Display Off setting can be used to automatically turn off the display when the control panel is not being operated.

* To prevent the CN29 digital piano's OLED display from 'burn in' as a result of showing the same screen for an extended period of time, this setting is enabled by default.

■ Auto Display Off setting

Auto Power Off	Description
15 sec.	The display will turn off automatically after 15 seconds of inactivity.
5 min. (default)	The display will turn off automatically after 5 minutes of inactivity.
30 min.	The display will turn off automatically after 30 minutes of inactivity.

* When the display turns off automatically, pressing any control panel button will turn it on again.

1. Changing the Auto Display Off setting

After entering the Auto Display Off setting:

Press the [UP] or [DOWN] buttons to change the value of the Auto Display Off setting.

* This setting will be stored automatically, and recalled every time the instrument is turned on.

* To reset this setting to the default value, press the [UP] and [DOWN] buttons simultaneously.

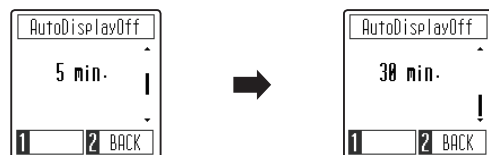

2 Exiting the Auto Display Off setting

Press the [2] function button (BACK) to exit the Auto Display Off setting and return to the Settings menu.



16 Auto Power Off

The Auto Power Off setting can be used to automatically turn off the instrument after a specified period of inactivity. This function may be enabled by default, depending on the market location.

* This setting will be stored automatically, and recalled every time the instrument is turned on.

■ Auto Power Off setting

Auto Power Off	Description
Off	The Auto Power Off function is disabled.
15 min.	The instrument will turn off automatically after 15 minutes of inactivity.
60 min.	The instrument will turn off automatically after 60 minutes of inactivity.
120 min.	The instrument will turn off automatically after 120 minutes of inactivity.

1. Changing the Auto Power Off setting

After entering the Auto Display Off setting:

Press the [UP] or [DOWN] buttons to change the value of the Auto Power Off setting.

* This setting will be stored automatically, and recalled every time the instrument is turned on.

* To reset this setting to the default value, press the [UP] and [DOWN] buttons simultaneously.



2 Exiting the Auto Power Off setting

Press the [2] function button (BACK) to exit the Auto Power Off setting and return to the Settings menu.



17 Startup Settings

The Startup Settings function allows preferred settings to be stored in the CN29 digital piano's memory, and automatically recalled as the default settings every time the instrument is turned on.

■ Settings stored in Startup Settings memory

Selected Sound

Dual Mode / Four Hands Mode Settings

Metronome (Beat, Tempo, Volume)

Settings

MIDI Settings *

* For information regarding MIDI functions and settings, please download the supplementary PDF manual from the Kawai Global website: <http://www.kawai-global.com/support/manual>

1. Storing the Startup Settings

After entering the Startup Settings function:

A confirmation message will be shown in the display, prompting to confirm or cancel the Startup Settings store operation.

Press the [1] function button (YES) to confirm the Startup Setting store operation, or the [2] function button (NO) to cancel.

When the Startup Setting memory has been stored, the display will return to the Settings menu automatically.

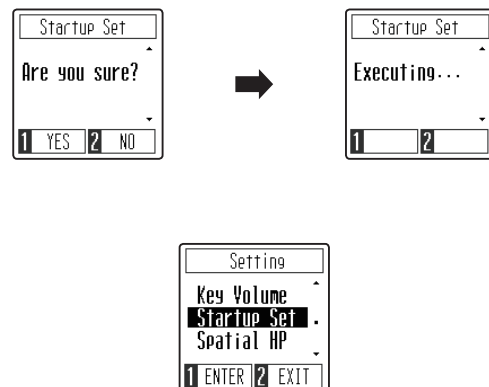

18 Factory Reset

The Factory Reset function clears any settings stored using the Startup Settings function, restoring the CN29 digital piano back to its factory default configuration.

1. Restoring factory settings

After entering the Factory Reset function:

A confirmation message will be shown in the display, prompting to confirm or cancel the Factory Reset operation.

Press the [1] function button (YES) to confirm the Factory Reset operation, or the [2] function button (NO) to cancel.

When the memory has been reset, the display will return to the Settings menu automatically.

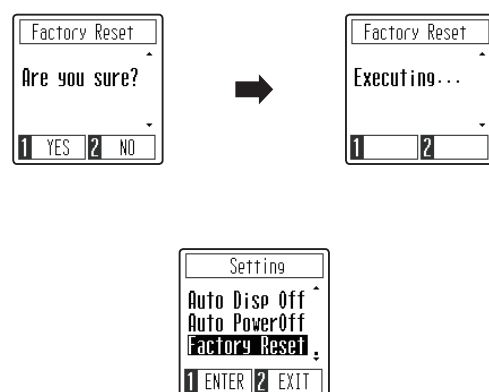

Connecting to Other Devices

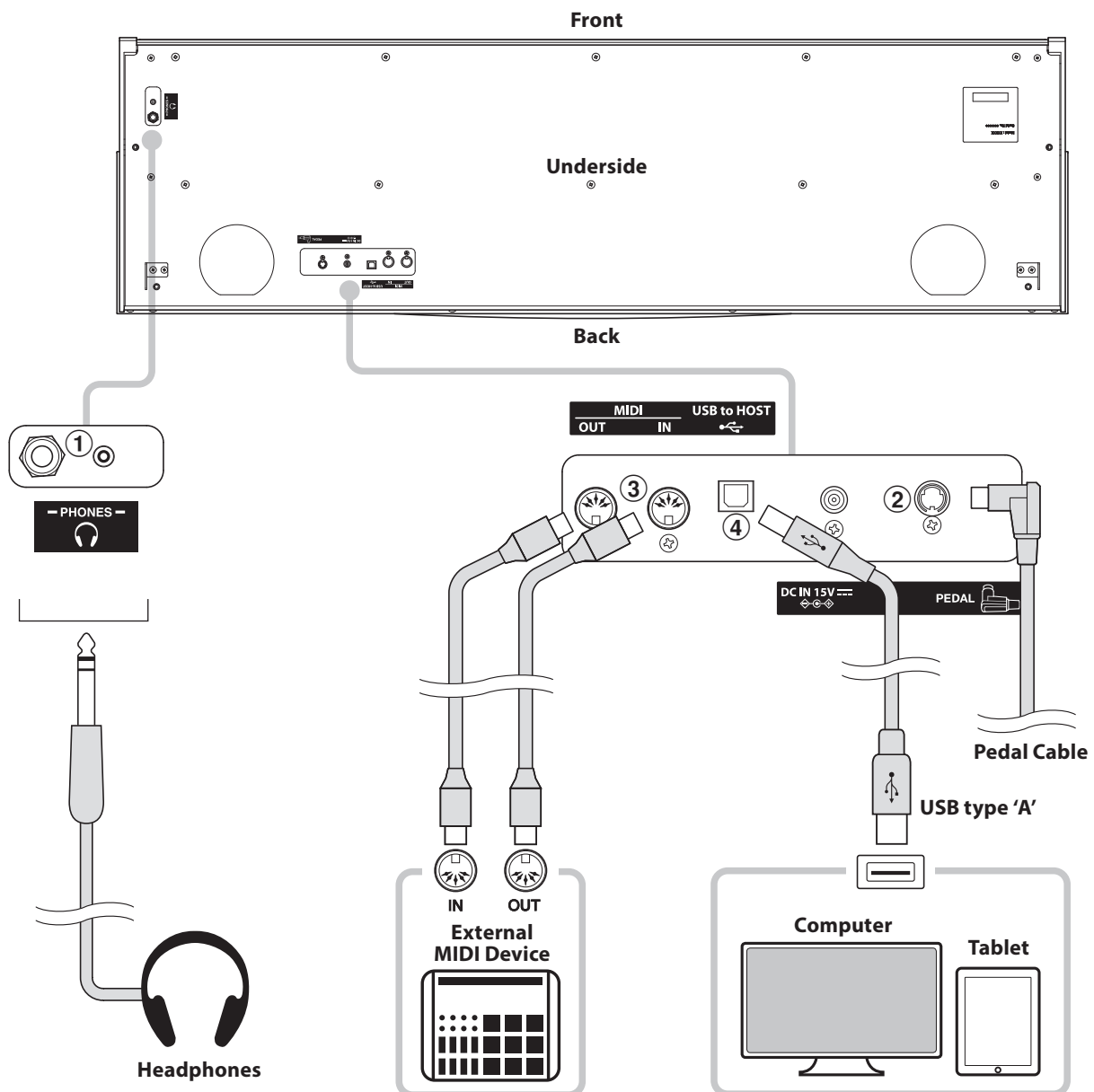

① PHONES jacks (1/4" & 1/8" phone jacks)

These jacks are used to connect stereo headphones to the CN29 digital piano. Headphones can be connected and used simultaneously. When a pair of headphones is connected, sound will not be produced by the speakers.

② PEDAL connector

This connector is used to connect the pedal board to the CN29 digital piano (see page 58).

③ MIDI IN/OUT jacks

These jacks are used to connect the CN29 digital piano to external MIDI devices, such as a sound module, or a computer with a MIDI interface.

④ USB to Host port ('B' type)

This port is used to connect the CN29 digital piano to a computer using an inexpensive USB cable. When connected, the instrument can be used as a standard MIDI device, allowing it to send and receive MIDI data. Connect a 'B' type USB connector to the instrument, and an 'A' type USB connector to the computer.

With additional conversion adaptors, this port may also be used to connect the CN29 digital piano to tablets and other mobile devices.

USB MIDI (USB to Host connector)

The CN29 digital piano features a 'USB to Host' type connector, allowing the instrument to be connected to a computer using an inexpensive USB cable and utilised as a MIDI device. Depending on the type of computer and operating system installed, additional driver software may be required for USB MIDI communication to function correctly.

■ USB MIDI driver

Operating System	USB MIDI Driver Support
Windows Vista (SP1, SP2) Windows Vista 64-bit (SP1, SP2) Windows 7 Windows 7 64-bit Windows 8 Windows 8 64-bit Windows 8.1 Windows 8.1 64-bit Windows 10 Windows 10 64-bit	The standard (built-in) Windows USB-MIDI driver is used. This driver will be installed automatically when the instrument is connected to the computer. To enable MIDI communication between the application software and the instrument, select "USB-MIDI" as a MIDI device.
Windows Vista (no SP) Windows Vista 64-bit (no SP)	USB-MIDI is not supported. Please upgrade to Service Pack 1 or Service Pack 2.
Windows 98 SE Windows 2000 Windows ME Windows XP (no SP, SP1, SP2, SP3) Windows XP 64-bit	Windows XP or earlier versions are not supported. Please use a third-party MIDI interface for MIDI connection.
Mac OS X	Additional USB MIDI driver software NOT required. The standard (built-in) Mac OS X USB MIDI driver will be installed automatically when the instrument is connected to the computer.
Mac OS 9	USB MIDI is not supported. Please use the standard MIDI IN/OUT connectors.

■ USB MIDI information

- If the instrument's MIDI IN/OUT jacks and USB MIDI port are both connected simultaneously, the USB MIDI port will be given priority.
- Ensure that the instrument is turned OFF before attempting to connect the USB MIDI cable.
- When connecting the instrument to a computer using the USB MIDI port, there may be a short delay before communications begin.
- If the instrument is connected to a computer via a USB hub and USB MIDI communication becomes unreliable/unstable, please connect the USB MIDI cable directly to the one of the computer's USB ports.
- Disconnecting the USB MIDI cable suddenly, or turning the instrument on/off while using USB MIDI may cause computer instability in the following situations:
 - while installing the USB MIDI driver
 - while starting up the computer
 - while MIDI applications are performing tasks
 - while the computer is in energy saver mode
- If there are any further problems experienced with USB MIDI communication while the instrument is connected, please double-check all connections and relevant MIDI settings in the computer's operating system.

* 'MIDI' is a registered trademark of the Association of Manufacturers of Electronic Instruments (AMEI).

* 'Windows' is registered trademark of Microsoft Corporation.

* 'Macintosh' and 'iPad' are registered trademark of Apple Computer, Inc.

* Other company names and product names mentioned referenced herein may be registered trademarks or trademarks of respective owners.

* Bluetooth® word marks and logos are registered trademarks owned by Bluetooth SIG, Inc. Kawai uses these marks and logos under the license. Other trademarks and trade names belong to their respective owners.

* Bluetooth (Ver 4.1 GATT compatible) / Bluetooth Low Energy MIDI Specification is supported.

Troubleshooting

	Problem	Possible Cause and Solution	Page no.
Power	The instrument does not turn on.	Check that the power cable is firmly attached to the instrument, and connected to an AC outlet.	p. 14
	The instrument turns itself off after a period of inactivity.	Check that the 'Auto Power Off' function is not enabled.	p. 50
Sound	The instrument is turned on, however no sound is produced when the keys are played.	Check that the MASTER VOLUME slider is not set to the lowest position. Check that a pair of headphones (or headphone adaptor plug) are not connected to the PHONES jack. Check that Local Control is enabled in the MIDI Settings menu.	p. 16 p. 16 "MIDI Settings Manual" p. 5
	The sound distorts when playing at very loud volume levels.	Check that the MASTER VOLUME slider is set to an appropriate level, reducing the volume if excessive distortion is heard.	p. 16
	The pitch or sound quality with a specific piano timbre is odd.	The CN29 digital piano attempts to reproduce the rich variety of tones created by an acoustic grand piano as accurately as possible. This includes damper resonances and other subtle effects that contribute to the overall piano playing experience. While these additional effects are intended to enhance the realism of the instrument, it is possible to reduce their prominence, or disable them altogether using the sound settings.	p. 38 p. 43
Pedals	The pedals are unreliable or do not function at all.	Check that the pedal cable is firmly connected to the instrument.	p. 58
	When depressing a pedal, the pedal board flexes and is not firm.	Check that the pedal support bolt is fully extended.	p. 17
	The top 18 notes of the keyboard sustain for longer than neighbouring notes, even when the damper pedal is not pressed.	This is the correct behaviour, and intended to reproduce the undamped notes (typically the top two octaves) of an acoustic grand piano.	—
	The instrument produces a 'swoosh' sound when the damper pedal is pressed.	The CN29 digital piano reproduces the sound of dampers on a grand piano touching and releasing the strings. If this intentional sound is undesirable, it may be prevented by selecting the 'Noiseless' Virtual Technician preset, or by adjusting the 'Damper Noise' setting.	p. 43 p. 44
USB MIDI, MIDI, Bluetooth® MIDI	The instrument is connected to the computer using a USB cable (or a USB-MIDI adaptor), however the software does not respond to key presses.	Check that a USB MIDI driver is installed on the computer. Check that 'USB Audio Device' or 'KAWAI USB MIDI' is selected in the software's input/output device settings. Check that the instrument is not connected to a smart device using Bluetooth MIDI.	p. 53 p. 53 p. 48
	The instrument cannot connect to the smart device/app via Bluetooth.	Check that the instrument's Bluetooth MIDI function is turned On. Ensure that the mobile device's Bluetooth function is turned On. Try deleting the instrument's Bluetooth connection using the mobile device's 'Forget Device' function. Try turning the instrument Off and then On, and/or restarting the mobile device.	p. 48
Keyboard	The volume level is different between piano keys.	Try using the Key Volume setting to adjust the volume of the key(s) that are too quiet or too loud.	p. 45

Assembly Instructions



Please read these assembly instructions thoroughly before attempting to assemble the CN29 digital piano.

Please ensure that two or more people work on assembling the CN29 digital piano, especially when lifting the main body of the instrument onto the stand.

■ Included parts

Before attempting to assemble the CN29 digital piano, ensure that all parts below are included.

A Phillips-head screwdriver (not included) will also be required in order to assemble the instrument.

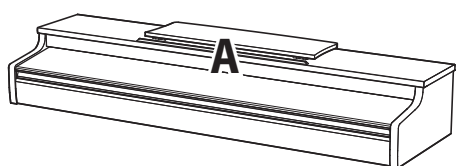

Main body

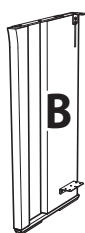

Side panel (left & right)

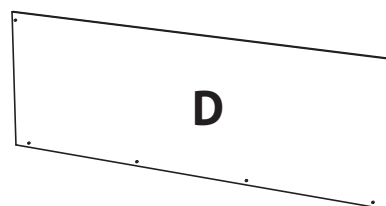

Back board



Pedal board
(including adjustor bolt)

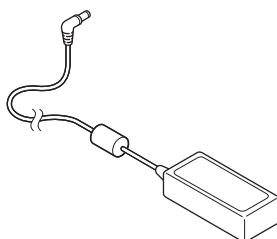

AC/DC adaptor

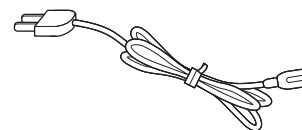

Power cable

Screw set

- a** Screw (with flat washer and spring washer) x 4



- b** Tapping screw (long, black, 4 x 30 mm) x 2 *



- c** Tapping screw (short, black, 4 x 20 mm) x 4 *



- d** Tapping screw (silver, 4 x 16 mm) x 4



* For Satin White finished instruments, black screws will be replaced with silver screws.

* The **d** tapping screws are provided in a separate bag.

Headphone hook set

Headphone hook



Mounting screw x 2
(4 x 14 mm)



Assembly Instructions

1. Attaching the side panels to the pedal board

- 1 Unfasten and extend the pedal connection cable attached to the bottom of the pedal board (E).
- 2 Attach the pedal board (E) to the left (B) and right (C) side panels using the temporary mounting screws located on either end of the pedal board.
- 3 Ensure that the pedal board and side panels make close contact, and that there are no large gaps between the assembled parts.
- 4 Insert the four short silver tapping screws **d** into the holes as shown, and securely fasten the pedal board to the left and right side panels.

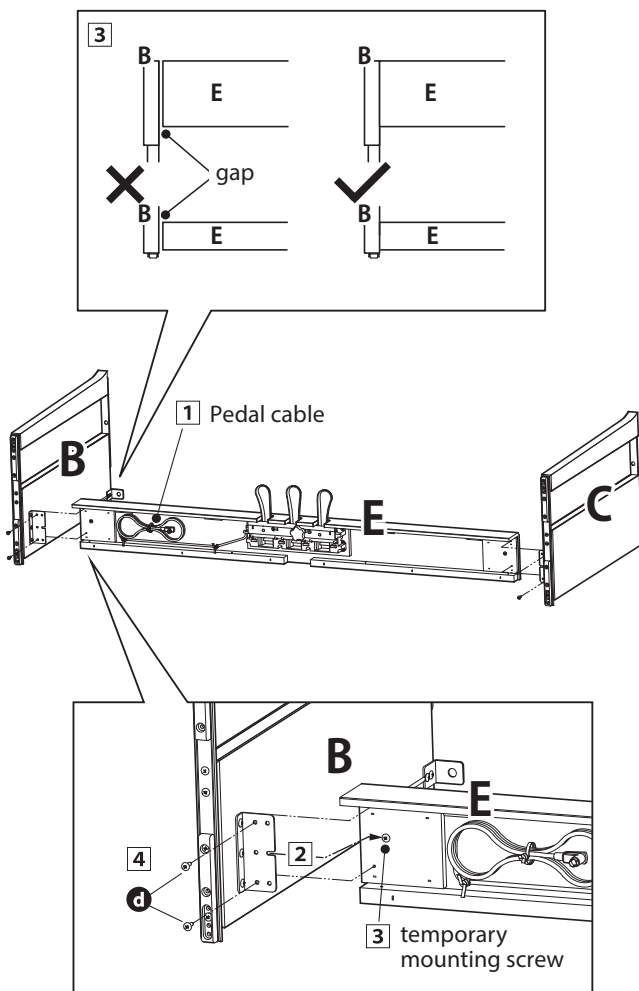

2. Attaching the back board

- 1 Allow the assembled pedal board and side panels to stand upright (vertically) on the floor.
 - * Ensure that the adjustor bolt is attached to the pedal board.
- 2 Loosely attach the back board (D) to the left and right side panels using the four long black tapping screws **b***.
- 3 Loosely attach the bottom of the back board to the pedal board using the four mid-length black or silver tapping screws **c***.
- 4 Adjust the positioning of the pedal board, side panels, and backboard to ensure that all parts are in alignment, then tighten the screws in steps 2 and 3.

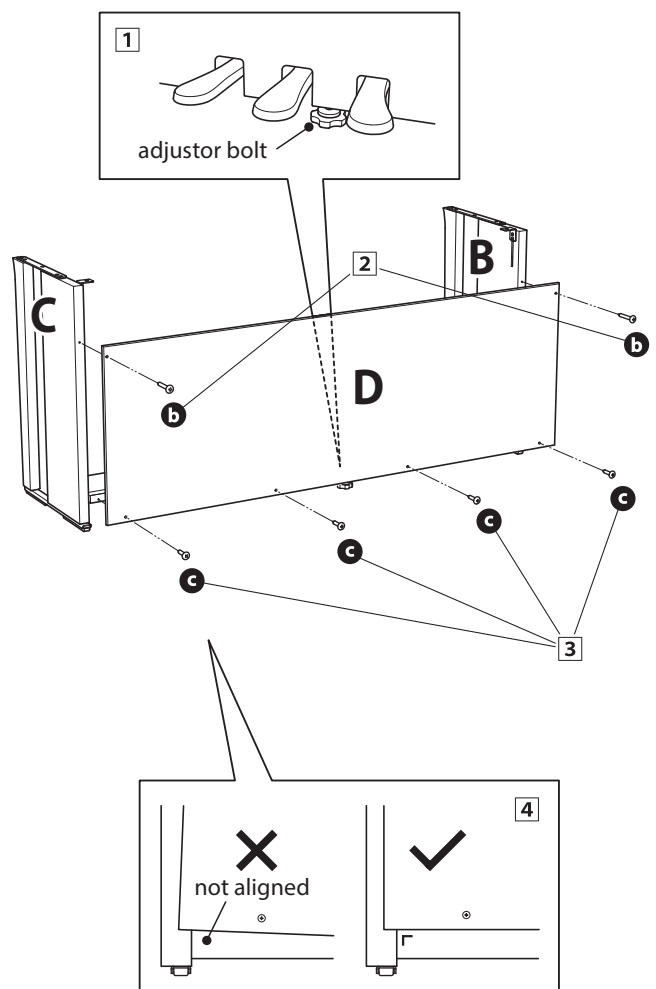

* For Satin White finished instruments, black screws will be replaced with silver screws.

3. Mounting the main body onto the stand



Ensure that two or more people undertake the following step of the assembly process.

- 1 Lift the main body (A) and carefully place it onto the stand. Position the main body towards the front of the stand, so that the metal fitting holes are visible when viewed from above.
- 2 Gently slide the main body backwards until the base engages with the stand fixings and locks into place. When positioned correctly, the attachment screw holes should be visible from the underside of the main unit.

* If the screw holes are not visible, re-adjust (loosen) the screws attached in step 2-4.



When lifting the main body onto the stand, be careful not to catch/trap hands and fingers.

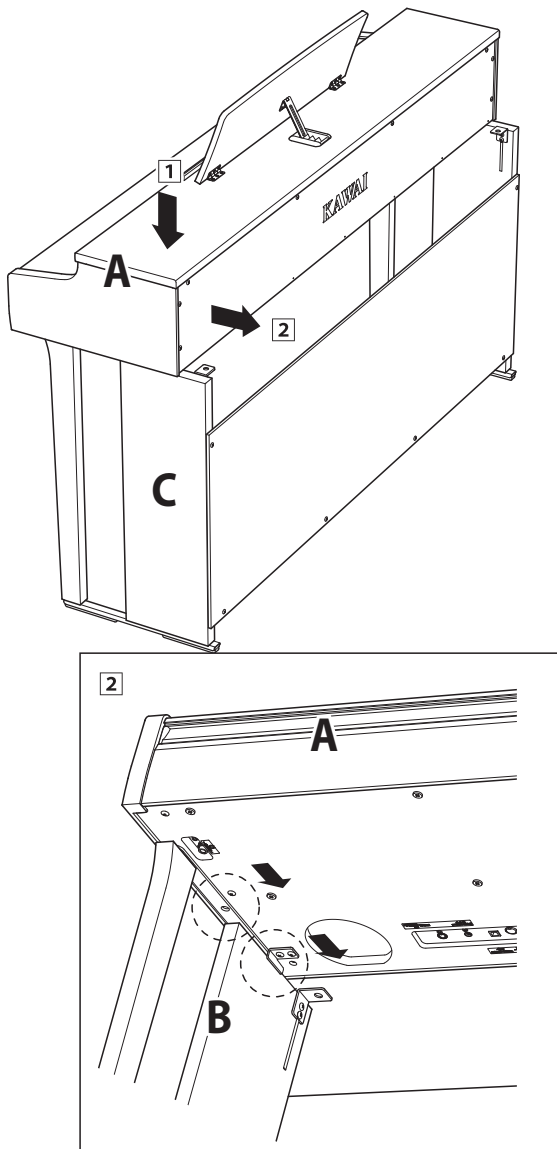

4. Fastening the main body to the stand

- 1 View the front of the instrument to ensure that the main body and side panels are in alignment.

* If the parts are not in alignment, re-adjust (loosen) the screws attached in step 2-1.

- 2 Loosely fasten the front of the main body to the stand from below, using two screws (with washer) (a) on either side.
- 3 Loosely fasten the rear of the main body to the stand from below, using the remaining two screws (with washer) (a) on either side.
- 4 When all four screws are attached and the main body is correctly positioned on top of the stand, securely tighten all screws.



Tighten all screws securely to ensure that the main body is firmly attached to the stand.

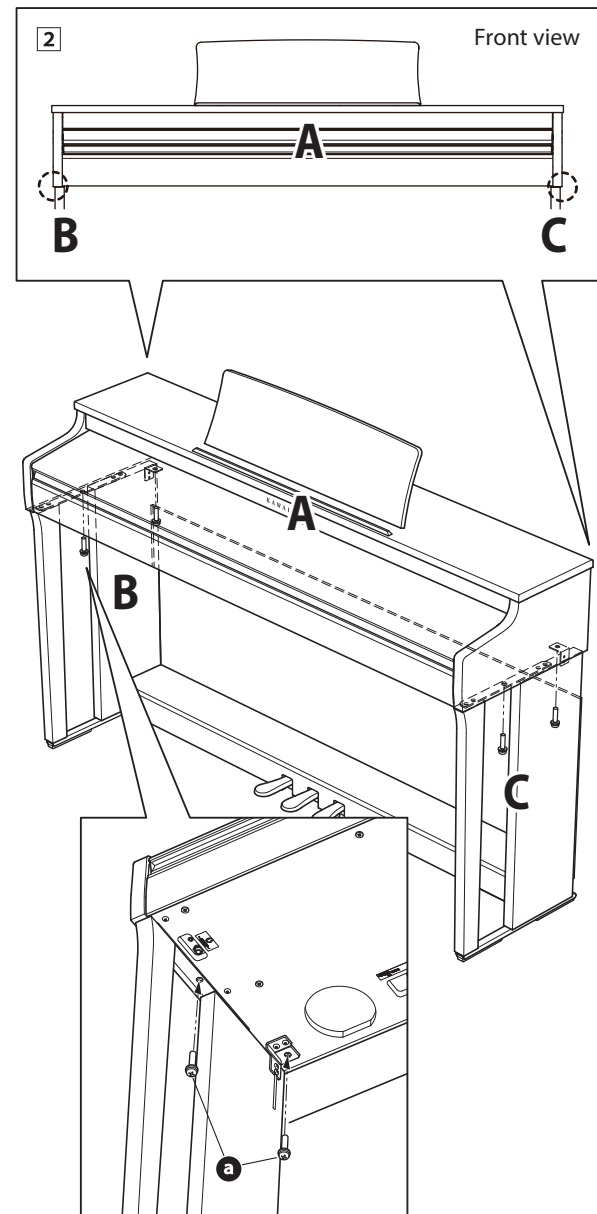

Assembly Instructions

5. Connecting the power adaptor & pedal cables

- 1 Connect the AC/DC power adaptor to the DC IN terminal on the underside of the main body, then pass the cable through the back board aperture, and out to the rear of the instrument.
- 2 Pass the pedal cable (extending from the rear of the pedal board) through the aperture to the front of the main body, and connect to the PEDAL terminal.
- 3 With the power adaptor and pedal cables connected, use the binders to fix the cables in place and tidy their appearance.

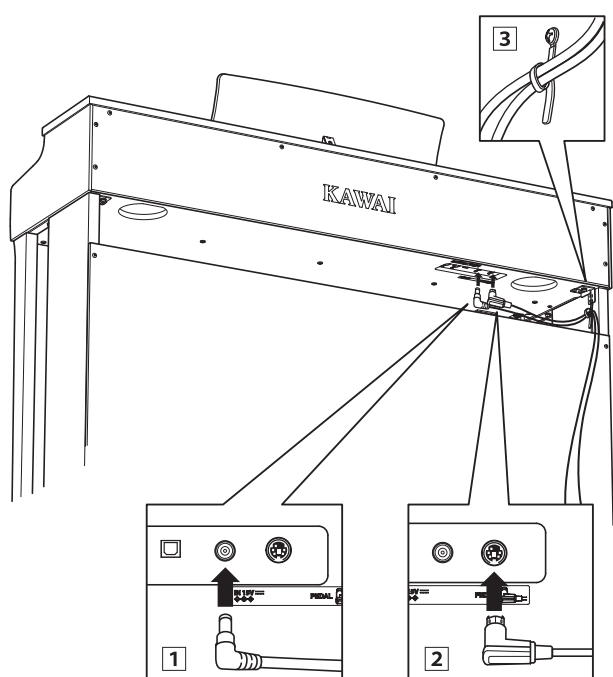

To avoid damaging the plugs or bending the pins, connect the plugs with the correct orientation, and do not apply excessive force when connecting.

6. Attaching the headphone hook (optional)

A headphone hook is included with the CN29 digital piano and can be used to hang headphones when not in use.

- 1 If desired, attach the headphone hook to the underside of the main body using the two tapping screws provided.

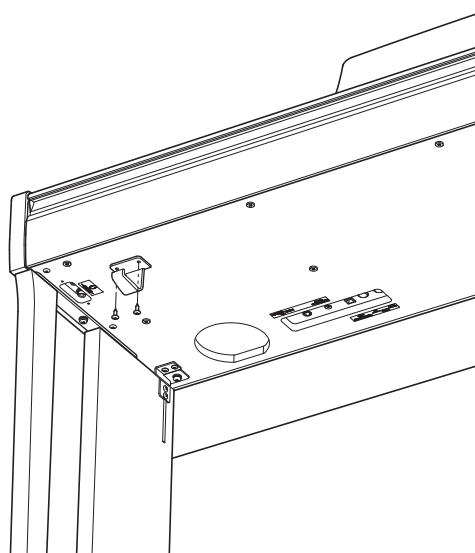

7. Adjusting the pedal support bolt

- 1 Turn the pedal support bolt anti-clockwise, extending the bolt until it makes contact with the floor and supports the pedals firmly.

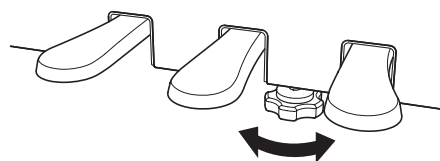

When moving the instrument, always adjust or remove the pedal support bolt, then readjust when the instrument is in its new position.

Demo Song List

Sound Name	Song Title	Composer
SK Concert Grand	La Campanella	Liszt
EX Concert Grand	Hungarian Rhapsodies No.6	
Upright Piano	Alpenglühén Op.193	Oesten
Studio Grand	Original	
Studio Grand 2	Original	Kawai
Mellow Grand	Sonata No.30 Op.109	Beethoven
Mellow Grand 2	La Fille aux Cheveux de lin	Debussy
Modern Piano	Original	
Classic E.Piano	Original	
Modern E.Piano	Original	Kawai
Jazz Organ	Original	
Church Organ	Chorale Prelude "Wachet auf, ruft uns die Stimme."	
Harpsichord	French Suite No.6	Bach
Vibraphone	Original	Kawai
String Ensemble	Le quattro stagioni: la "Primavera"	Vivaldi
Slow Strings	Original	Kawai
Choir	Londonderry Air	Irish folk song
New Age Pad	Original	
Atmosphere	Original	Kawai

Concert Magic Song List

No.	Song name	Composer
1	Twinkle, Twinkle, Little Star	French folk song
2	I'm A Little Teapot	Traditional
3	Mary Had A Little Lamb	American folk song
4	London Bridge	Traditional
5	Row, Row, Row Your Boat	American folk song
6	Frère Jacques	French folk song
7	Old MacDonald Had A Farm	American folk song
8	Hark The Herald Angels Sing	Mendelssohn
9	Jingle Bells	Traditional
10	Deck The Halls	Welsh Air
11	O Come All Ye Faithful	J.Reading
12	Joy To The World	Traditional
13	Silent Night	Traditional
14	We Wish You A Merry Christmas	British folk song
15	Battle Hymn Of The Republic	Traditional
16	Yankee Doodle	American folk song
17	Londonderry Air	Irish folk song
18	Clementine	American folk song
19	Auld Lang Syne	Scottish folk song
20	Oh Susanna	S.C.Foster
21	The Camptown Races	S.C.Foster
22	When The Saints Go Marching In	American folk song
23	The Entertainer	S.Joplin
24	William Tell Overture	Rossini
25	Andante from Symphony No.94 (Haydn)	Haydn
26	Für Elise	Beethoven
27	Clair De Lune	Debussy
28	Skater's Waltz	E.Waldteufel
29	Blue Danube Waltz	Strauss
30	Gavotte (Gossec)	Gossec
31	Waltz Of The Flowers	Tchaikovsky
32	Bridal Chorus	Wagner
33	Wedding March	Mendelssohn
34	Pomp And Circumstance	Elgar
35	When Irish Eyes Are Smiling	E.R.Ball
36	Chiapanecas	Mexican folk song
37	Santa Lucia	Naplish folk song
38	Funiculi Funiculà	L.Denza
39	Romance De L'amour	Spanish folk song
40	My Wild Irish Rose	Chauncy Alcote

Lesson Function Song Lists

No.	Alfred's Basic Piano Library Lesson Book Level 1A
1	Right & Left
2	Left & Right
3	Merrily We Roll Along/O'er the Deep Blue Sea
4	Hand-Bells
5	Jolly Old Saint Nicholas
6	Old MacDonald
7	Batter Up!
8	My Clever Pup
9	The Zoo
10	Playing in a New Position
11	Sailing
12	Skating
13	Wishing Well
14	Rain, Rain!
15	A Happy Song
16	Position C
17	A Happy Song
18	See-Saws
19	Just a Second!
20	Balloons
21	Who's on Third?
22	Mexican Hat Dance
23	Rock Song
24	Rockets
25	Sea Divers
26	Play a Fourth
27	July the Fourth!
28	Old Uncle Bill
29	Love Somebody
30	My Fifth
31	The Donkey
32	Position G
33	Jingle Bells!
34	Willie & Tillie
35	A Friend Like You
36	My Robot
37	Rockin' Tune
38	Indian Song
39	Raindrops
40	It's Halloween!
41	Horse Sense

No.	Alfred's Basic Piano Library Lesson Book Level 1B
1	Step Right Up!
2	The Carousel
3	Hail to Thee, America!
4	Brother John
5	Good Sounds
6	The Cuckoo
7	Money Can't Buy Ev'rything!
8	Ping-Pong
9	Grandpa's Clock
10	When the Saints Go Marching In
11	G's in the "BAG"
12	Join the Fun
13	Oom-Pa-pa!
14	The Clown
15	Thumbs on C!
16	Waltz Time
17	Good King Wenceslas
18	The Rainbow
19	Yankee Doodle
20	The Windmill
21	Indians
22	New Position G
23	Pedal Play
24	Harp Song
25	Concert Time
26	Music Box Rock
27	A Cowboy's Song
28	The Magic Man
29	The Greatest Show on Earth!
30	The Whirlwind
31	The Planets
32	C Major Scale Piece
33	G Major Scale Piece
34	Carol in G Major
35	The Same Carol in C Major
36	French Lullaby
37	Sonatina
38	When Our Band Goes Marching By!

No.	Burgmüller 25 (25 Etudes Faciles, Opus 100)
1	La candeur
2	Arabesque
3	Pastorale
4	Petite réunion
5	Innocence
6	Progrès
7	Courant Limpide
8	La gracieuse
9	La chasse
10	Tendre fleur
11	La bergeronnette
12	Adieu
13	Consolation
14	La styrienne
15	Ballade
16	Douce plainte
17	Babillarde
18	Inquiétude
19	Ave Maria
20	Tarentelle
21	Harmonie des anges
22	Barcarolle
23	Retour
24	L'hirondelle
25	La chevaleresque

Czerny 30 (Etudes de Mécanisme, Opus 849)
No. 1 to No. 30

Beyer 106 (Vorschule im Klavierspiel, Opus 101)
No. 1 (1-1 to 1-12)
No. 2 (2-1 to 2-8)
No. 3 to No. 106

Chopin Walzer (Chopin waltzes series 1-19)
Grande Valse Brillante Op.18
Valse Brillante Op.34-1
Valse Op.34-2
Valse Brillante Op.34-3
Grande Valse Op.42
Valse Op.64-1
Valse Op.64-2
Valse Op.64-3
Valse Op.69-1
Valse Op.69-2
Valse Op.70-1
Valse Op.70-2
Valse Op.70-3
Valse KK Iva No.15
Valse KK Iva No.12
Valse KK Iva No.13
Valse KK Iva No.14
Valse? KK Ivb No.10
Valse KK Ivb No.11

■ Lesson Function song book availability

Alfred's Basic Piano Library, Burgmüller: *Etudes Faciles*, Czerny: *Etudes de Mécanisme*, and Beyer lesson song books are sold separately. Please check your local dealer for more information. Alfred's international offices may also be contacted directly:

USA / Canada
 Alfred Music Publishing
 PO Box 10003
 Van Nuys, CA 91410
 Tel: +1 (800) 292-6122
 Email: sales@alfred.com
 Website: <https://www.alfred.com>

Australia
 Alfred Publishing Australia
 PO Box 2355
 Taren Point NSW 2229
 Tel: +61 (02) 9524 0033
 Email: sales@alfredpub.com.au

Specifications

■ Kawai CN29 digital piano

Keyboard	88 weighted keys with Ivory Touch key surfaces Responsive Hammer III (RHIII) action with Let-Off, Triple Sensor, and Counterweights	
Sound Source	Progressive Harmonic Imaging™ (PHI), 88-key piano sampling	
Internal Sounds	SK Concert Grand, EX Concert Grand, Upright Piano, Studio Grand, Studio Grand 2, Mellow Grand, Mellow Grand 2, Modern Piano, Classic E.Piano, Modern E.Piano, Jazz Organ, Church Organ, Harpsichord, Vibraphone, String Ensemble, Slow Strings, Choir, New Age Pad, Atmosphere	
Polyphony	max. 192 notes	
Reverb	Room, Lounge, Small Hall, Concert Hall, Live Hall, Cathedral	
Internal Recorder	3 song recorder – approximately 10,000 note memory capacity	
Lesson Function	Alfred, Burgmüller, Czerny, Chopin, and Beyer lesson songs	
Metronome	Beat: 1/4, 2/4, 3/4, 4/4, 5/4, 3/8, 6/8 Tempo: 10~300 bpm	
Demo Songs	19 songs	
Keyboard Modes	Dual Mode (with adjustable volume balance) Four Hands Mode	
Virtual Technician	Smart Mode:	10 presets
	Advanced Mode: (adjustable via iPad app)	Touch Curve, Voicing, Damper Resonance, Damper Noise, String Resonance, Key-off Effect, Fall-back Noise, Hammer Delay, Topboard Simulation, Decay Time, Minimum Touch, Stretch Tuning, Temperament, Temperament Key, Key Volume, Half-Pedal Adjust, Soft Pedal Depth
Other Functions	Tone Control, Tuning, Transpose, Touch, Spatial Headphone Sound, Phones Type, Transmit Program Change Number, MIDI Channel, Local Control, Multi-timbral mode, Startup Settings, Auto Display Off, Auto Power Off, Bluetooth MIDI	
Display	128 x 128 pixel OLED	
Bluetooth *	Bluetooth (Ver. 4.1; GATT compatible) Bluetooth Low Energy MIDI Specification compliant	
Pedals	Sustain (with half-pedal support), Soft, Sostenuto	
Jacks	MIDI (IN/OUT), Headphones x 2, USB to HOST	
Speakers	12 cm x 2	
Output Power	20 W x 2	
Power Consumption	12 W (PS-154 AC adaptor)	
Key Cover	Sliding type	
Dimensions	1360 (W) x 405 (D) x 860 (H) (Folding music rest)	
Weight	43.0 kg	

Specifications are subject to change without notice.

* Availability of Bluetooth function dependent on market location.

KAWAI

THE FUTURE OF THE PIANO

