

BASS STATION II



USER GUIDE

Novation
A division of Focusrite Audio Engineering Ltd.
Windsor House,
Turnpike Road,
Cressex Business Park,
High Wycombe,
Bucks,
HP12 3FX.
United Kingdom

Tel: +44 1494 462246
Fax: +44 1494 459920
e-mail: sales@novationmusic.com
Web: <http://www.novationmusic.com>

Trademarks

The Novation trademark is owned by Focusrite Audio Engineering Ltd. All other brand, product and company names and any other registered names or trade marks mentioned in this manual belong to their respective owners.

Disclaimer

Novation has taken all possible steps to ensure that the information given here is both correct and complete. In no event can Novation accept any liability or responsibility for any loss or damage to the owner of the equipment, any third party, or any equipment which may result from use of this manual or the equipment which it describes. The information provided in this document may be modified at any time without prior warning. Specifications and appearance may differ from those listed and illustrated.

IMPORTANT SAFETY INSTRUCTIONS

1. Read these instructions.
2. Keep these instructions.
3. Heed all warnings.
4. Follow all instructions.
5. Do not use this apparatus with water.
6. Clean only with dry cloth.
7. Do not install near any heat sources such as radiators, heat registers, stoves, or other apparatus (including amplifiers) that produce heat.
8. Do not defeat the safety purpose of the polarized or grounding-type plug. A polarized plug has two blades with one wider than the other. A grounding type plug has two blades and a third grounding prong. The wide blade or the third prong are provided for your safety. If the provided plug does not fit into your outlet, consult an electrician for replacement of the obsolete outlet.
9. Protect the power cord from being walked on or pinched particularly at plugs, convenience receptacles, and the point where they exit from the apparatus.
10. Only use attachments/accessories specified by the manufacturer.
11.  Use only with the cart, stand, tripod, bracket, or table specified by the manufacturer, or sold with the apparatus. When a cart is used, use caution when moving the cart/apparatus combination to avoid injury from tip-over.
12. Unplug this apparatus during lightning storms or when unused for long periods of time.
13. Refer all servicing to qualified service personnel. Servicing is required when the apparatus has been damaged in any way, such as power-supply cord or plug is damaged, liquid has been spilled or objects have fallen into the apparatus, the apparatus has been exposed to rain or moisture, does not operate normally, or has been dropped.
14. No naked flames, such as lighted candles, should be placed on the apparatus.

WARNING: Excessive sound pressure levels from earphones and headphones can cause hearing loss.

WARNING: This equipment must only be connected to USB 1.1 or 2.0 type ports.



CAUTION: TO REDUCE THE RISK OF ELECTRIC SHOCK, DO NOT REMOVE COVER (OR BACK). NO USER-SERVICABLE PARTS INSIDE. REFER SERVICING TO QUALIFIED SERVICE PERSONNEL.



The lightning flash with arrowhead symbol within an equilateral triangle is intended to alert the user to the presence of uninsulated "dangerous voltage" within the product's enclosure that may be of sufficient magnitude to constitute the risk of electric shock to persons.



The exclamation point within an equilateral triangle is intended to alert the user to the presence of important operating and maintenance (servicing) instructions in the literature accompanying the appliance.

WARNING: TO REDUCE THE RISK OF FIRE OR ELECTRIC SHOCK, DO NOT EXPOSE THIS APPARATUS TO RAIN OR MOISTURE.

ENVIRONMENTAL DECLARATION

Compliance Information Statement: Declaration of Compliance procedure

Product Identification:	Novation Bass Station II keyboard
Responsible party:	American Music and Sound
Address:	4325 Executive Drive, Suite 300 Southaven, MS 38672
Telephone:	800-431-2609

This device complies with part 15 of the FCC Rules. Operation is subject to the following two conditions: (1) This device may not cause harmful interference, and (2) this device must accept any interference received, including interference that may cause undesired operation.

For USA

To the User:

1. **Do not modify this unit!** This product, when installed as indicated in the instructions contained in this manual, meets FCC requirements. Modifications not expressly approved by Novation may void your authority, granted by the FCC, to use this product.
2. **Important:** This product satisfies FCC regulations when high quality shielded USB cables with integral ferrite are used to connect with other equipment. Failure to use high quality shielded USB cables with integral ferrite or to follow the installation instructions within this manual may cause magnetic interference with appliances such as radios and televisions and void your FCC authorization to use this product in the USA.
3. **Note:** This equipment has been tested and found to comply with the limits for a Class B digital device, pursuant to part 15 of the FCC Rules. These limits are designed to provide reasonable protection against harmful interference in a residential installation. This equipment generates, uses and can radiate radio frequency energy and, if not installed and used in accordance with the instructions, may cause harmful interference to radio communications. However, there is no guarantee that interference will not occur in a particular installation. If this equipment does cause harmful interference to radio or television reception, which can be determined by turning the equipment off and on, the user is encouraged to try to correct the interference by one or more of the following measures:
 - Reorient or relocate the receiving antenna.
 - Increase the separation between the equipment and receiver.
 - Connect the equipment into an outlet on a circuit different from that to which the receiver is connected.
 - Consult the dealer or an experienced radio/TV technician for help.

For Canada

To the User:

This Class B digital apparatus complies with Canadian ICES-003.

Cet appareil numérique de la classe B est conforme à la norme NMB-003 du Canada.

RoHS Notice

Novation has conformed and product conforms, where applicable, to the European Union's Directive 2002/95/EC on Restrictions of Hazardous Substances (RoHS) as well as the following sections of California law which refer to RoHS, namely sections 25214.10, 25214.10.2, and 58012, Health and Safety Code; Section 42475.2, Public Resources Code.

CAUTION:

The normal operation of this product may be affected by a strong electrostatic discharge (ESD). In the event of this happening, simply reset the unit by removing and then replugging the USB cable. Normal operation should return.

COPYRIGHT AND LEGAL NOTICES

Novation is a registered trade mark of Focusrite Audio Engineering Limited.
Bass Station II is a trade mark of Focusrite Audio Engineering Limited.

2013 © Focusrite Audio Engineering Limited. All rights reserved.

CONTENTS

IMPORTANT SAFETY INSTRUCTIONS	2	SIMPLIFIED BASS STATION II BLOCK DIAGRAM	12
ENVIRONMENTAL DECLARATION	2	BASS STATION II IN DETAIL	12
For USA	2	The Oscillator Section	12
For Canada	2	Waveform	12
COPYRIGHT AND LEGAL NOTICES	2	Pitch	12
INTRODUCTION	4	Modulation	12
Key Features	4	Pulse Width	13
About This Manual	4	Oscillator Sync	13
What's In The Box	4	The Sub Oscillator	13
Registering your Bass Station II	4	The Mixer Section	13
Power Requirements	4	The Filter Section	13
Hardware Overview	5	Filter type	13
GETTING STARTED	7	Frequency	14
Loading Patches	7	Resonance	14
Saving Patches	7	Filter modulation	14
Basic Operation – sound modification	7	Overdrive	14
The LED display	7	The Envelopes Section	14
The Filter knob	7	Portamento	15
Pitch and Mod wheels	7	The Effects Section	15
Octave Shift	7	The LFO Section	15
Transpose	8	LFO 1:	15
On-Key functions	8	LFO 2:	15
Local control	8	LFO Waveforms	16
SYNTHESIS TUTORIAL	8	LFO Speed	16
Pitch	8	LFO Delay	16
Tone	8	LFO Speed/Sync	16
Volume	8	LFO Keysync	16
The Oscillators And Mixer	9	LFO Slew	16
Sine Waves	9	The Arpeggiator Section	16
Triangle Waves	9	Arp Swing	17
Sawtooth Waves	9	The Sequencer	17
Square / Pulse Waves	9	Record	17
Noise	9	Play	17
Ring Modulation	9	SEQ Retrig	17
The Filter	10	On-key Functions	17
Envelopes And Amplifier	10	APPENDIX	19
Attack Time	11	Importing Patches via SysEx	19
Decay Time	11	Sync values table	19
Sustain Level	11	Init Patch – parameter table	20
Release Time	11	Synth settings saved on power-off	20
LFOs	11	Synth settings not saved on power-off	20
Summary	11	MIDI parameters list	21
		MIDI implementation table	21

INTRODUCTION

Thank you for purchasing this Bass Station II digitally-controlled analogue synthesizer. Based on the classic 1990s Novation Bass Station synth, it combines traditional analogue waveform generation and processing with the power and flexibility of digital control, plus a set of effects and presets for the 21st century.

NOTE: Bass Station II is capable of generating audio with a large dynamic range, the extremes of which can cause damage to loudspeakers or other components, and also to your hearing!

Key Features

- Classic analogue waveform generation
- Two multi-waveform oscillators plus separate sub oscillator
- Analogue signal path – filters, envelopes, modulation
- Traditional “single function” style rotary controls
- LP/BP/HP filters with variable slope
- Separate dual LFO section
- Ring Modulator (inputs: Oscs 1 and 2)
- Versatile 32-step arpeggiator with wide range of patterns
- 32-step sequencer with four memories
- Portamento with dedicated time control
- Pre-loaded with 64 brand new Killer Patches
- Memory for 64 additional User Patches
- Pitch and Mod wheels
- 25-note velocity-sensitive keyboard with aftertouch
- -5/+4 octave keyboard shift
- Key transpose function
- On-Key functions – use the keyboard to adjust non-performance sound parameters
- MIDI input and output
- LED display for patch selection, parameter adjustment, octave settings, etc.
- External DC input (for supplied AC PSU)
- Class-compliant USB port (no drivers required), for alternative DC power, patch dump and MIDI
- External audio input to mixer section
- Headphone output
- Sustain pedal socket
- Kensington Security Slot

About This Manual

We've tried to make this manual as helpful as possible for all types of user, and this inevitably means that more experienced users will want to skip over certain parts of it, while relative novices will want to avoid certain parts of it until they're confident they've mastered the basics.

However, there are a few general points that are useful to know about before you continue reading this manual. We've adopted some graphical conventions within the text, which we hope all types of user will find helpful in navigating through the information to find what they need to know quickly:

Abbreviations, conventions, etc.

Where top panel controls or rear panel connectors are referred to, we've used a number thus: **1** to cross-reference to the top panel diagram, and thus: **1** to cross-reference to the rear panel diagram. (See page 5 and page 6).

We've used **BOLD TEXT (or Bold Text)** to name top panel controls or rear panel connectors; we've made a point of using exactly the same names as appear on the Bass Station II. We've used **SEVEN-SEGMENT DIGITS** to denote numbers that appear on the top panel LED display.

Tips



These do what it says on the tin: we include bits of advice, relevant to the topic being discussed that should simplify setting up Impulse to do what you want. It's not mandatory that you follow them, but generally they should make life easier.



These are additions to the text that will be of interest to the more advanced user and can generally be avoided by the novice. They are intended to provide a clarification or explanation of a particular area of operation.

What's In The Box

Your Bass Station II has been carefully packed in the factory and the packaging was designed to withstand rough handling. Should the unit appear to have been damaged in transit, do not discard any of the packing material and notify your music dealer.

If practical, save all the packing materials in case you ever need to ship the unit again.

Please check the list below against the contents of the packaging. If any items are missing or damaged, contact the Novation dealer or distributor where you purchased the unit.

- Bass Station II synthesizer
- DC power supply unit (PSU)
- USB cable
 - Registration card, also providing on-line access to:
 - Loopmasters Sample Content
- Ableton Live Lite
- This manual

Registering your Bass Station II

It is important to register your Bass Station II on-line, using the Warranty Registration Card provided. Apart from validating your manufacturer's warranty, you will also then be able to download the additional software that you are entitled to as a Bass Station II purchaser. Follow the instructions on the Registration Card.

Power Requirements

Bass Station II is shipped with a 9 V DC, 500 mA power supply. The centre pin of the coaxial connector is the positive (+ve) side of the supply. Bass Station II can either be powered by this AC-to-DC mains adaptor, or by a USB connection to a computer. To obtain the best possible audio performance from Bass Station II we recommend using the supplied adaptor.

There are two versions of the PSU, your Bass Station II will be supplied with the one appropriate to your country. In some countries the PSU comes with detachable adaptors; use the one that fits your country's AC outlets. When powering Bass Station II with the mains PSU, please ensure that your local AC supply is within the range of voltages required by the adaptor – i.e., 100 to 240 VAC - BEFORE you plug it into the mains.

We strongly recommend that you only use the supplied PSU. Using alternative PSUs will invalidate your warranty. Power supplies for your Novation product can be purchased from your music dealer if you have lost yours.

If the synth is powered via the USB port, note that it will “go to sleep” if the host computer goes into power save mode. The synth can be “woken-up” again by pressing any key; however, this does not alter the power status of the computer.



A word about laptops:

If powering your Bass Station II via the USB connection you should be aware that although the USB specification agreed by the IT industry states that a USB port should be able to supply 0.5 A at 5 V, some computers - particularly laptops – are unable to supply this current. Unreliable operation of the synth will result in such a case. When powering Bass Station II from a laptop's USB port, it is strongly recommended that the laptop is powered from AC mains rather than its internal battery.

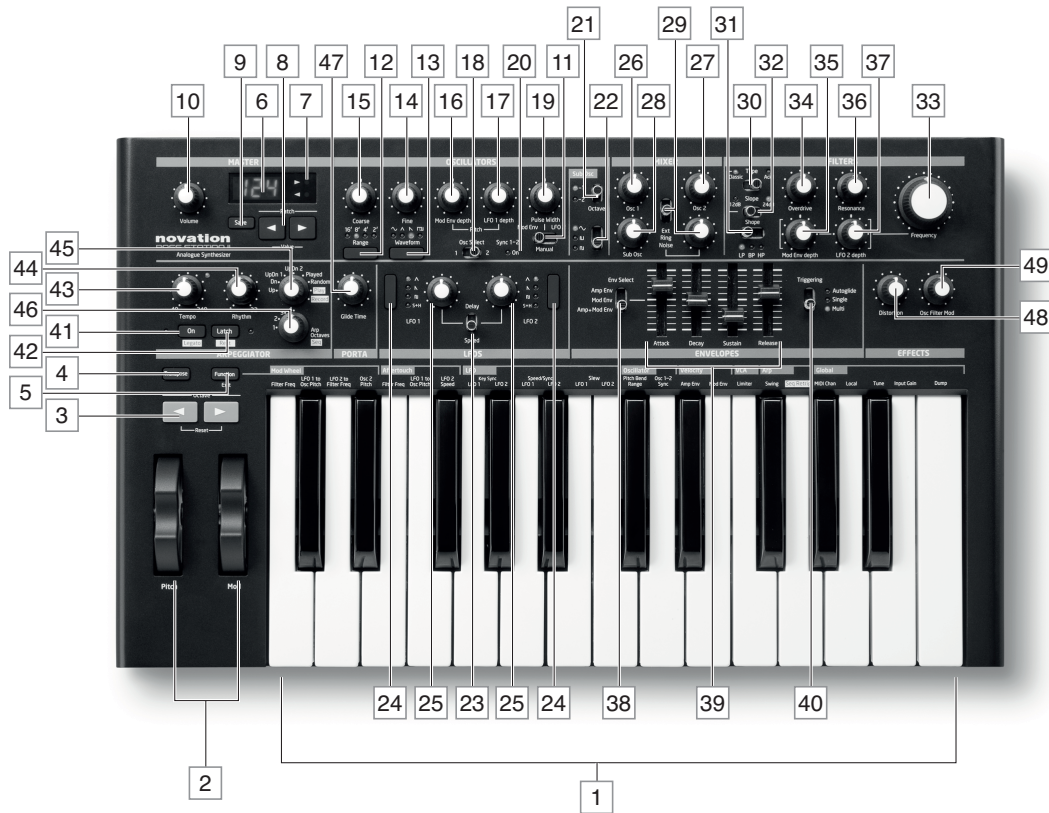

- 1 25-note (two octaves) velocity-sensitive keyboard with aftertouch.
- 2 **Pitch** and **Mod** wheels: The Pitch wheel is mechanically biased to return to the centre position when released. The wheels are internally illuminated.
- 3 **Octave** shift keys – transpose the keyboard in octave increments.
- 4 **Transpose** - lets you transpose the keyboard in semitone increments, up to a maximum of +/- 12 semitones.
- 5 **Function/Exit** – hold this down to use any of Bass Station II's On-Key Functions. A wide range of "system set-up" parameters can be set in this mode.

Master section:

- 6 LED display – a three-character alphanumeric display showing various items of unit data – e.g., patch number, octave shift and parameter values – depending on which other controls are in use.
- 7 **Org. Value** – one of these two LEDs will illuminate when the value of a parameter no longer matches the value stored for the patch.
- 8 **Patch/Value** – allows selection of one of the 64 Factory or 64 User Patches, and are also used to set parameter values for On-Key functions.
- 9 **Save** – use in conjunction with **Patch** keys 8 to save modified Patches in User Memories.
- 10 **Volume** – sets the Bass Station II's audio volume.

Oscillator section:

- 11 **Osc Select** switch – assigns the controls in the Oscillator section to Oscillator 1 or Oscillator 2.
- 12 **Range** – steps through the base pitch ranges of the selected oscillator. For standard concert pitch (A3 = 440 Hz), set to 8'.
- 13 **Waveform** – steps through the range of available oscillator waveforms – sine, triangular, sawtooth and pulse.
- 14 **Coarse** – adjusts the pitch of the selected oscillator over a range of ±1 octave.
- 15 **Fine** – adjusts the oscillator pitch over a range of ±100 cents (±1 semitone).
- 16 **Mod Env depth** – controls the degree by which the oscillator pitch changes as a result of modulation by Envelope 2; the control is 'centre-off', so that either pitch increases or decreases can be obtained.
- 17 **LFO 1 depth** – controls the degree by which the oscillator pitch changes as a result of modulation by LFO 1.
- 18 **Pulse width modulation source** – active only when **Waveform** 13 is set to Pulse; this switch selects the method of varying the width of the pulse waveform. The options are: modulation by Envelope 2 (**Mod Env**), modulation by LFO 2 (**LFO 2**) or manual control by the **Pulse Width** control 19.

- 19 **Pulse Width** – a multi-functional control adjusting the pulse waveform; only active when **Waveform** 13 is set to Pulse. When the pulse width source modulation switch 18 is set to **Manual**, the control adjusts the pulse width directly; when set to **Mod Env** or **LFO 2**, it acts as a Modulation Depth control. Note that the pulse width may be modulated by all three sources simultaneously, by differing amounts.
- 20 **Sync 1-2** – this LED illuminates when the Osc 1/Osc 2 Sync function is enabled (an On-Key Function)
- 21 **Octave** – sets the range of the sub-octave oscillator; the actual pitch of this oscillator is determined by OSC 1's pitch, and adds additional bass frequencies (LF) to the sound. -1 adds LF one octave below OSC 1, -2 adds LF two octaves below.
- 22 **Sub Osc Wave** – a choice of three waveforms is available for the sub-octave oscillator: sine, narrow pulse or square.

LFO section:

- 23 **LFO Delay/Speed** – the two rotary controls in the LFO section are dual-function, the function being set by this switch. In **Speed** mode, the rotary controls adjust the frequencies of the two LFOs. In **Delay** mode, they set the "fade-in" time for the LFO. Speed mode can be changed to **Sync** mode by using one of the On-key functions. See "Mod Wh: Filter Freq (bottom C)" on page 17 for further information.
- 24 **LFO waveform** – these buttons step through the available waveforms for each LFO independently: triangle, sawtooth, square, sample and hold. The associated LEDs give a visual indication of the LFO speed and waveform.
- 25 **LFO rotary controls** – these two controls either adjust LFO speed or delay, as set by the LFO Delay/Speed switch [23].

Mixer section:

- 26 **OSC 1** – adjusts the proportion of Oscillator 1's signal making up the sound.
- 27 **OSC 2** – adjusts the proportion of Oscillator 2's signal making up the sound.
- 28 **Sub** – adjusts the proportion of the sub-octave oscillator making up the sound. Additional inputs - up to three further sources may contribute to the synth output; this control sets their levels. The control's function is set by switch 30.
- 29 **Noise/Ring/Ext** – determines the function of rotary control 29. When set to **Noise**, the rotary control sets the amount of white noise added to the sound; when set to **Ring**, it sets the amount of the output from the Ring Modulator circuit is added (the inputs to the Ring Modulator are Osc 1 and Osc 2); in the **Ext** position, an external signal connected to the rear panel connector 6 can be mixed in.

Filter section:

- 30 Type** – two-position switch selecting filter type: **Classic** configures a variable filter, whose basic characteristics may be set with the **Shape** and **Slope** switches **32** and **33**; **Acid** configures a 4-pole diode ladder lo-pass filter, which emulates a type of filter found on early '80s analogue synths.
- 31 Shape** – three-position switch; with **Type** set to **Classic**, sets the filter characteristic to be lo-pass (**LP**), band-pass (**BP**) or hi-pass (**HP**).
- 32 Slope** – two-position switch; with **Type** set to **Classic**, sets the slope of filter beyond the passband to either **12dB** or **24dB** per octave.
- 33 Frequency** – large rotary knob controlling the filter's cut-off frequency (LP or HP), or its centre frequency (BP).
- 34 Resonance** – adds resonance (an increased response at the filter frequency) to the filter characteristic.
- 35 Overdrive** – adds a degree of pre-filter distortion to the mixer output.
- 36 Mod Env depth** – controls the degree by which the filter frequency is modified by the Mod Envelope.
- 37 LFO 2 depth** – controls the degree by which the filter frequency is modified by LFO 2.

Envelopes Section:

- 38 Env Select** – assigns the Envelope faders [40] to vary the parameters of the Amplitude Envelope (**Amp Env**), Modulation Envelope (**Mod Env**), or both simultaneously (**Amp+Mod Env**).
- 39 Envelope controls** – a set of four faders adjusting the standard ADSR Envelope parameters (**Attack**, **Decay**, **Sustain** and **Release**).
- 40 Triggering** – three-position switch controlling how envelopes work with legato and portamento playing styles.

Arpeggiator section:

- 41 On/Legato** – turns the arpeggiator on and off. Also allows notes in a recorded arp sequence to be tied, or played in a Legato style.
- 42 Latch/Rest** – sets the arpeggiator to play the current pattern continuously. Also allows a musical rest to be inserted in an arp sequence. When the arpeggiator is off, the Latch/Rest button enables a Key Hold function, which simulates the effect of holding a key down continuously, until another key is pressed.
- 43 Tempo** – sets the arp pattern tempo in the range 40 to 240 BPM.
- 44 Rhythm** – selects one of 32 pre-defined arp rhythmic patterns. The LED display indicates the pattern number.
- 45 Arp Mode** – the arp can play the notes making up the selected pattern in a variety of sequences; Arp Mode sets the sequence, and can also put the arp into **Record** and **Play** modes for patterns based on the notes actually played rather than on the pre-defined sequences.
- 46 Arp Octaves/SEQ** – 4-position rotary switch setting the number of octaves over which the arp pattern plays. This control also selects one of four global sequences when Arp Mode is set to **Play** or **Record**.

Portamento section:

- 47 Glide Time** – sets the portamento glide time; with the control fully anticlockwise, portamento is 'off'.

Effects section:

- 48 Distortion** – controls the amount of post-filter distortion added to the synth output.
- 49 Osc Filter Mod** – allows the filter frequency to be modulated directly by Oscillator 2.



- 1 POWER IN** – connect the supplied PSU here when powering Bass Station II from AC mains.
- 2 Power switch** – three-position switch: centre is **OFF**, set to **ext DC** if using the supplied AC mains PSU, set to **USB** if powering Bass Station II from a computer via a USB cable.
- 3 USB** – standard USB 1.1 port (2.0-compatible). Connect to a Type A USB port on a computer using the supplied cable.
- 4 MIDI IN and OUT** – standard 5-pin DIN MIDI sockets for connecting Bass Station II to other MIDI-equipped hardware.
- 5 SUSTAIN** – 2-pole (mono) 1/4" jack socket for connection of a sustain pedal. Both N/O (Normally Open) and N/C (Normally Closed) pedal types are compatible; if the pedal is connected when the Bass Station II is powered on, the type will be automatically sensed during boot-up (provided your foot is not on the pedal!).
- 6 EXT IN** – 1/4" jack socket for external microphone, instrument or line level audio inputs. Input is unbalanced. An audio source connected here may be mixed with the synth sound.
- 7 LINE OUTPUT (MONO)** – 1/4" jack socket carrying the Bass Station II's output signal; connect your recording system, amplifier and speakers, audio mixer, etc. Output is unbalanced.
- 8 HEADPHONES** – 3-pole 1/4" jack socket for stereo headphones (though synth output is mono). Phones volume is adjusted by the VOLUME control [10].
- 9 Kensington Security Slot** – to secure your synth.

GETTING STARTED

Bass Station II may be used as a standalone synthesizer, or with MIDI connections to/ from other sound modules or keyboards. It may also be connected - via its USB port - to a computer (Windows or Mac). The USB connection can supply power to the synth, transfer MIDI data to/from a MIDI sequencer application and allow Patches to be saved to memory.

The simplest and quickest way of getting started with Bass Station II is to connect the rear panel jack socket marked **LINE Output** (7) to the input of a power amplifier, audio mixer, powered speaker, third-party computer sound card or other means of monitoring the output.

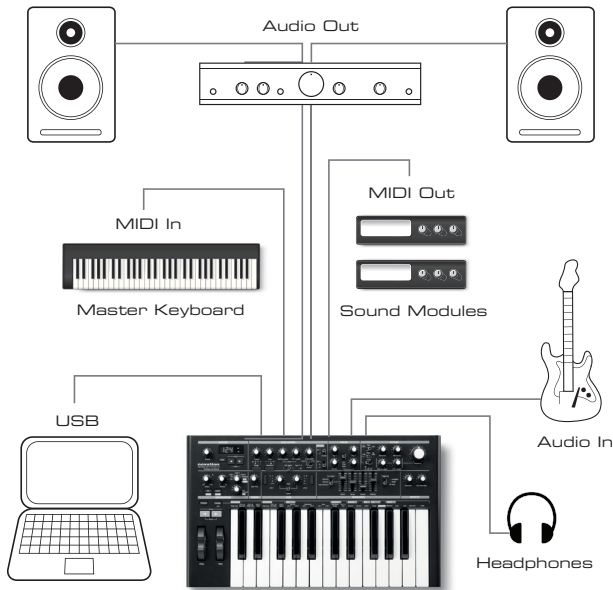

Note: Bass Station II is not a computer MIDI interface. MIDI can be transmitted between the synth and computer via the USB connection, but MIDI cannot be transferred between the computer and external equipment via Bass Station II's MIDI DIN ports.

If using Bass Station II with other sound modules, connect **MIDI OUT** (4) on the synth to **MIDI IN** on the first sound module, and daisy-chain further modules in the usual way. If using Bass Station II with a master keyboard, connect the master keyboard's **MIDI OUT** to **MIDI IN** on the synth, and ensure that the master keyboard is set to output on MIDI channel 1 (the synth's default channel).

With the amplifier or mixer off or muted, connect the AC adaptor to the Bass Station II (1), and plug it into the AC mains. Turn the synth on by moving the rear panel switch (2) to **ext DC**. After completing its boot sequence, Bass Station will load Patch 0, and the LCD display will confirm this. For a list of initial synth settings which are not retained from the previous session, please see Synth settings unsaved from previous session in Appendix.

Turn on the mixer/amplifier/powerd speakers, and turn up the **VOLUME** control (10) until you have a healthy sound level from the speaker when you play.

Using headphones

Instead of a speaker and/or an audio mixer, you may wish to use a pair of headphones. These may be plugged into the rear panel headphone output socket (8). The main outputs are still active when headphones are plugged in. The **VOLUME** control (10) also adjusts headphone level.

NOTE: The Bass Station II headphone amplifier is capable of outputting a high signal level; please take care when setting the volume.

Loading Patches

Bass Station II can store 128 Patches in memory. 0 - 63 are pre-loaded with some great factory sounds. 64 - 127 are intended for storing user Patches, and are all pre-loaded with the same default "initial" Patch (see "Init Patch - parameter table" on page 20).

A Patch is loaded by simply scrolling up or down to the Patch number with the Patch buttons (8); the Patch is immediately active and the LED display shows the current patch number. The Patch buttons can be held down for fast scrolling.



Note that when you change Patch, you lose the current synth settings. If the current settings were a modified version of a stored Patch, these modifications will be lost. Thus it is always advisable to save your settings before loading a new patch. See Saving Patches below.

Saving Patches

Patches can be saved to any of the 128 memory locations (0 - 127), but remember that if you save your settings to any of Patches 0 - 63, you will overwrite one of the factory presets. To save a patch press the **Save** button (9). The LED display - showing the current patch number - will flash. To overwrite this Patch with your current settings, press the **Save** button again. The LED display will briefly indicate that the patch is being saved.

To save the current settings to a different memory to the Patch number on the display (as would be the case if you loaded a Patch, modified it in some way and then wished to save the modified version without overwriting the original version), press the **Save** button and then use the Patch buttons to select an alternative Patch memory while the display is flashing. Once selected, it is possible to audition the target patch (by using the keyboard) just to make sure that you are happy to overwrite it. Press the **Save** button once more to store the patch. The LED display will briefly indicate that the patch is being saved.

You can abort the Save procedure at the "LED flashing" stage by pressing the **Function/Exit** button (5). The Save procedure will cancel and Bass Station II will return to the patch being edited.



The Bass Station II Factory Patches can be downloaded from the Novation website if they have been accidentally overwritten. See "Importing Patches via SysEx" on page 19.

Basic Operation - sound modification

Once you have loaded a Patch you like the sound of, you can modify the sound in many different ways using the synth controls. Each area of the control panel is dealt with in greater depth later in the manual, but a few fundamental points should be discussed here:

The LED display

The three-segment alphanumeric display will normally show the number of the currently-loaded Patch (0 to 127). As soon as you change any "analogue" parameter - i.e., turn a rotary control or adjust an On-Key function, it will display the parameter value (most are either 0 to 127 or -63 to +63), with one of two arrows being highlighted (at the right-hand side). These arrows indicate which direction the control needs to be turned in order to match the value stored in the patch. It reverts to the Patch number display after the control is released.

The Filter knob

Adjusting the frequency of the synth's filter is probably the most commonly-used method of sound modification. For this reason, Filter **Frequency** has its own dedicated large rotary control (34) at the panel top right. Experiment with different types of patch to hear how changing the filter frequency alters the characteristic of different types of sound.

Pitch and Mod wheels

Bass Station II is fitted with a standard pair of synthesizer control wheels (2) adjacent to the keyboard, **Pitch** and **Mod** (Modulation). The **Pitch** control is spring-loaded and always returns to the centre position.

Moving **Pitch** will always raise or lower the pitch of the note(s) being played. The maximum range of operation is 12 semitones up or down, but this may be adjusted using On-Key function **Oscillator: Pitch Bend Range** (Upper C#).

The **Mod** wheel's precise function varies with the patch loaded; it is used in general to add expression or various elements to a synthesized sound. A common use is to add vibrato to a sound.

It is possible to assign the **Mod** wheel to alter various parameters making up the sound - or a combination of parameters simultaneously. This topic is discussed in more detail elsewhere in the manual. See 'On-key functions (mod wheel) on page 17.

Octave Shift

These two buttons (3) transpose the keyboard up or down one octave each time they are pressed, to a maximum of four octaves downwards, or five octaves upwards. The number of octaves by which the keyboard is shifted is indicated by the LED display. Pressing both buttons together (Reset) returns the keyboard to its default pitch, where the lowest note on the keyboard is one octave below Middle C.

SYNTHESIS TUTORIAL

This section covers the general principles of electronic sound generation and processing in more detail, including references to Bass Station II's facilities where relevant. It is recommended that this chapter is read carefully if analogue sound synthesis is an unfamiliar subject. Users familiar with this subject can skip this section and move on to the next.

To gain an understanding of how a synthesizer generates sound it is helpful to have an appreciation of the components that make up a sound, both musical and non-musical.

The only way that a sound may be detected is by air vibrating the eardrum in a regular, periodic manner. The brain interprets these vibrations (very accurately) into one of an infinite number of different types of sound.

Remarkably, any sound may be described in terms of just three properties, and all sounds always have them. They are:

- Pitch
- Tone
- Volume

What makes one sound different from another is the relative magnitudes of the three properties as initially present in the sound, and how the properties change over the duration of the sound.

With a musical synthesizer, we deliberately set out to have precise control over these three properties and, in particular, how they can be changed during the "lifetime" of the sound. The properties are often given different names: Volume may be referred to as Amplitude, Loudness or Level, Pitch as Frequency and Tone as Timbre.

Pitch

As stated, sound is perceived by air vibrating the eardrum. The pitch of the sound is determined by how fast the vibrations are. For an adult human, the slowest vibration perceived as sound is about twenty times a second, which the brain interprets as a bass type sound; the fastest is many thousands of times a second, which the brain interprets as a high treble type sound.

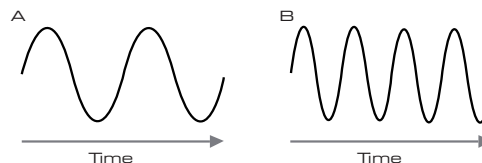

If the number of peaks in the two waveforms (vibrations) are counted, it will be seen that there are exactly twice as many peaks in Wave B as in Wave A. (Wave B is actually an octave higher in pitch than Wave A). It is the number of vibrations in a given period that determines the pitch of a sound. This is the reason that pitch is sometimes referred to as frequency. It is the number of waveform peaks counted during a given period of time which defines the pitch, or frequency.

Tone

Musical sounds consist of several different, related pitches occurring simultaneously. The loudest is referred to as the 'fundamental' pitch and corresponds to the perceived note of the sound. Other pitches making up the sound which are related to the fundamental in simple mathematical ratios are called harmonics. The relative loudness of each harmonic as compared to the loudness of the fundamental determines the overall tone or 'timbre' of the sound.

Consider two instruments such as a harpsichord and a piano playing the same note on the keyboard and at equal volume. Despite having the same volume and pitch, the instruments still sound distinctly different. This is because the different note-making mechanisms of the two instruments generate different sets of harmonics; the harmonics present in a piano sound are different to those found in a harpsichord sound.

Volume

Volume, which is often referred to as the amplitude or loudness of the sound, is determined by how large the vibrations are. Very simply, listening to a piano from a metre away would sound louder than if it were fifty metres away.



Middle C

Transpose

The keyboard may be transposed up or down one octave, in semitone increments.

To transpose, hold down the **Transpose** button [4], and hold down the key representing the key that you wish to transpose to. Transposition is relative to Middle C. For example, to shift the keyboard up four semitones, hold **Transpose** and press E above Middle C. To return to normal pitching, perform the same actions, only select Middle C as the target key.

The Arpeggiator

Bass Station II includes an arpeggiator, which allows arpeggios of varying complexity and rhythm to be played and manipulated in real-time. The arpeggiator is enabled by pressing the **Arp ON** button [42]; its LED will illuminate.

If a single key is pressed, the note will be retrIGGERED by the arpeggiator, at a rate determined by the **Tempo** control [44]. If you play a chord, the arpeggiator identifies its notes and plays them individually in sequence at the same rate (this is termed an arpeggio pattern or 'arp sequence'); thus if you play a C major triad, the selected notes will be C, E and G.

Adjusting the **Rhythm** [45], **Arp Mode** [46] and **Arp Octaves** [47] controls will alter the rhythm of the pattern, the way the sequence is played and the range in a variety of ways. See "The Arpeggiator Section" on page 16 for full details.

On-Key functions



To reduce the number of controls on Bass Station II (and hence make the synth smaller and neater!), a number of configuration and setup options have been assigned to the keyboard itself. Think of the keys as having a Shift (or Ctrl, or Fn) function, as on a computer keyboard; the On-Key functions are enabled by holding down the **Function/Exit** button [5] while pressing a key. The On-Key function for each key is printed on the top panel immediately above the keyboard.

Some On-Key functions are "bi-state" – i.e., they enable or disable something, while others are "analogue" parameters which consist of a range of values. Once the On-Key function mode has been entered, use the **Patch/Value** buttons [8] to alter its state or value.

Pressing **Function/Exit** a second time will exit the On-Key function mode or alternatively, if you wish to change another parameter, hold the **Function/Exit** button while pressing the key of the next parameter. See page 17 for full details of all the On-Key functions.

Local control

Bass Station II has a very high degree of MIDI implementation, and almost every control and synth parameter transmits MIDI data to external equipment, and similarly, the synth can be controlled in almost every respect by incoming MIDI data from a DAW or sequencer.

Local control is enabled/disabled via the On-Key function **Global: Local** (upper A). Hold the **Function/Exit** button [5] and press the key. Use the **Value** buttons [8] to switch Local control On or Off. The display will confirm the setting. Press **Function/Exit** to exit the On-Key mode. The default state is for Local mode to be On, so that the keyboard works! If you want to control the synth via MIDI from other equipment (such as a master keyboard), set Local mode to Off. Local mode is always set to ON after a power cycle.

Having shown that just three elements may define any sound, these elements now have to be related to a Musical synthesizer. It is logical that a different section of the Synthesizer 'synthesizes' (or creates) these different elements.

One section of the synthesizer, the **Oscillators**, provide raw waveform signals which define the pitch of the sound along with its raw harmonic content (tone). These signals are then mixed together in a section called the **Mixer**, and the resulting mixture is then fed into a section called the **Filter**. This makes further alterations to the tone of the sound, by removing (filtering) or enhancing certain of the harmonics. Lastly, the filtered signal is fed into the **Amplifier**, which determines the final volume of the sound.

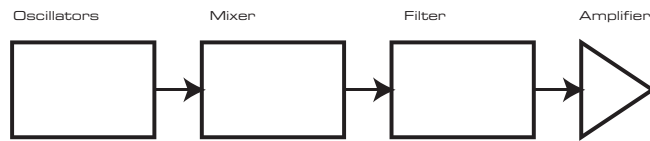

Additional synthesizer sections - **LFOs** and **Envelopes** - provide further ways of altering the pitch, tone and volume of a sound by interacting with the **Oscillators**, **Filter** and **Amplifier**, providing changes in the character of the sound which can evolve over time. Because **LFOs** and **Envelopes** only purpose is to control (modulate) the other synthesizer sections, they are commonly known as 'modulators'.

These various synthesizer sections will now be covered in more detail.

The Oscillators And Mixer

The Oscillator section is really the heartbeat of the synthesizer. It generates an electronic wave (which creates the vibrations when eventually fed to a loudspeaker). This Waveform is produced at a controllable musical pitch, initially determined by the note played on the keyboard or contained in a received MIDI note message. The initial distinctive tone or timbre of the waveform is actually determined by the waveform's shape.

Many years ago, pioneers of musical synthesis discovered that just a few distinctive waveforms contained many of the most useful harmonics for making musical sounds. The names of these waves reflect their actual shape when viewed on an instrument called an oscilloscope, and they are: Sine waves, Square waves, Sawtooth waves, Triangle waves and Noise. Bass Station II's Oscillator section can generate all these waveforms.

Each waveform shape (except Noise) has a specific set of musically-related harmonics which can be manipulated by further sections of the synthesizer.

The diagrams below show how these waveforms look on an oscilloscope, and illustrate the relative levels of their harmonics. Remember, it is the relative levels of the various harmonics present in a waveform which determine the tone of the final sound.

Sine Waves

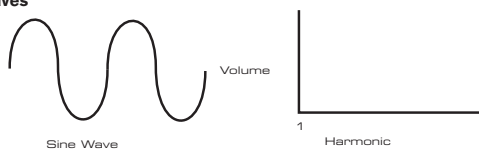

These possess just one harmonic. A sine waveform produces the "purest" sound because it only has this single pitch (frequency).

Triangle Waves



These contain only odd harmonics. The volume of each decreases as the square of its position in the harmonic series. For example, the 5th harmonic has a volume 1/25th of the volume of the fundamental.

Sawtooth Waves



These are rich in harmonics, and contain both even and odd harmonics of the fundamental frequency. The volume of each is inversely proportional to its position in the harmonic series.

Square / Pulse Waves

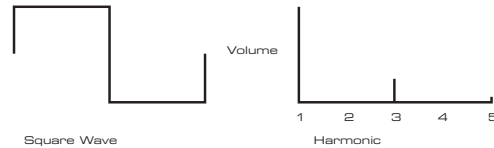

These contain only odd harmonics, which are at the same volume as the odd harmonics in a sawtooth wave.

It will be noticed that the square waveform spends an equal amount of time in its 'high' state as in its 'low' state. This ratio is known as the 'duty cycle'. A square wave always has a duty cycle of 50% which means it is 'high' for half the cycle and 'low' for the other half. Bass Station II lets you adjust the duty cycle of the basic square waveform to produce a waveform which is more 'rectangular' in shape. These are often known as Pulse waveforms. As the waveform becomes more and more rectangular, more even harmonics are introduced and the waveform changes its character, becoming more 'nasal' sounding.

The width of the pulse waveform (the 'Pulse Width') can be altered dynamically by a modulator, which results in the harmonic content of the waveform constantly changing. This can give the waveform a very 'fat' quality when the pulse width is altered at a moderate rate.

A pulse waveform sounds the same whether the duty cycle is - for example - 40% or 60%, since the waveform is just "inverted" and the harmonic content is exactly the same.

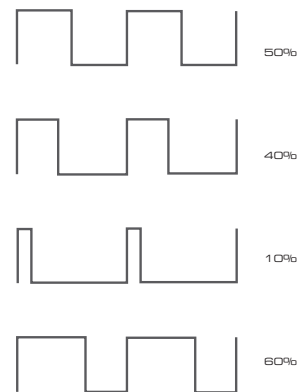

Noise

Noise is basically a random signal, and has no one fundamental frequency (and therefore no pitch property). All frequencies are present in noise, and all have the same volume. Because it possesses no pitch, noise is often useful for creating sound effects and percussion type sounds.



Ring Modulation

A Ring Modulator is a sound generator that takes signals from two oscillators and effectively "multiplies" them together. Bass Station II's Ring Modulator uses Oscillator 1 and Oscillator 2 as inputs. The resulting output depends on the various frequencies and harmonic content present in each of the two oscillator signals, and will consist of a series of sum and difference frequencies as well as the frequencies present in the original signals.

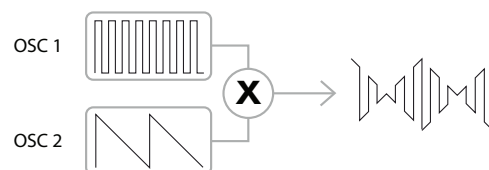

The Mixer

To extend the range of sounds that may be produced, typical analogue synthesizers have more than one Oscillator. By using multiple Oscillators to create a sound, it is possible to achieve very interesting harmonic mixes. It is also possible to slightly detune individual Oscillators against each other, which creates a very warm, 'fat' sound. Bass Station II's Mixer allows you create a sound consisting of the waveforms of Oscillators 1 and 2, the separate sub-octave oscillator, a Noise source, the Ring Modulator output and an external signal, all mixed together as required.

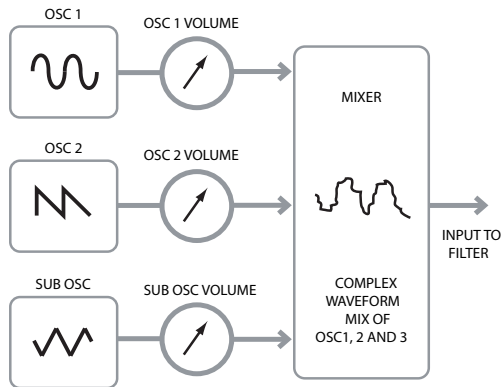

The Filter

Bass Station II is a subtractive music synthesizer. Subtractive implies that part of the sound is subtracted somewhere in the synthesis process.

The Oscillators provide the raw waveforms with plenty of harmonic content and the Filter section subtracts some of the harmonics in a controlled manner.

7 types of Filter are available on Bass Station II; they are all variations of the three basic filter types: Low Pass, Band Pass and High Pass. The type of Filter most commonly used on synthesizers is Low Pass. On a Low Pass Filter, a "cut-off frequency" is chosen and any frequencies below this are passed, while frequencies above are filtered out, or removed. The setting of the Filter Frequency parameter dictates the point above which frequencies are removed. This process of removing harmonics from the waveforms has the effect of changing the sound's character or timbre. When the Frequency parameter is at maximum, the filter is completely "open" and no frequencies are removed from the raw Oscillator waveforms.

In practice, there is a gradual (rather than a sudden) reduction in the volume of the harmonics above the cut-off point of a Low Pass Filter. How rapidly these harmonics reduce in volume as frequency increases above the cut-off point is determined by the Filter's slope. The slope is measured in 'volume units per octave'. Since volume is measured in decibels, this slope is usually quoted as so many decibels per octave (dB/oct). The higher the number, the greater the rejection of harmonics above the cut-off point, and the more pronounced the filtering effect. Bass Station II's filter section provides two slopes, 12 dB/oct and 24 dB/oct.

A further important parameter of the Filter is its Resonance. Frequencies at the cut-off point may be increased in volume by the Filter Resonance control. This is useful for emphasising certain harmonics of the sound.

As Resonance is increased, a whistling-like quality will be introduced to the sound passing through the filter. When set to very high levels, Resonance actually causes the filter to self-oscillate whenever a signal is being passed through it. The resulting whistling tone being produced is actually a pure sine wave, the pitch of which depends on the setting of the Frequency knob (the filter's cut-off point). This resonance-produced sine wave can actually be used for some sounds as an additional sound source if wished.

The diagram below shows the response of a typical low pass filter. Frequencies above the cut-off point are reduced in volume.

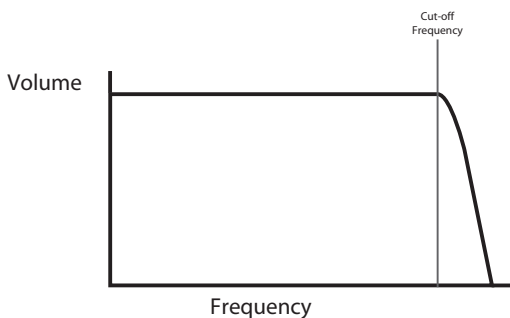

When resonance is added, the frequencies around the cut off point are boosted in volume.

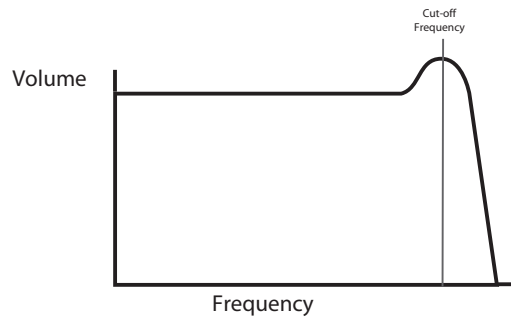

In addition to the traditional Low Pass Filter type, there are also High Pass and Band Pass types. On Bass Station II, the Filter type is selected with the **Shape** switch [32].

A High Pass Filter is similar to a Low Pass Filter, but works in the "opposite sense", so that frequencies below the cut-off point are removed. Frequencies above the cut-off point are passed. When the Filter Frequency parameter is set to zero, the filter is completely open and no frequencies are removed from the raw Oscillator waveforms.

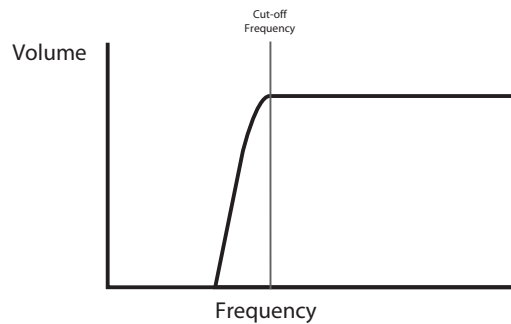

When a Band Pass Filter is used, only a narrow band of frequencies centered around the cut-off point are passed. Frequencies above and below the band are removed. It is not possible to fully open this type of Filter, and allow all frequencies to pass.

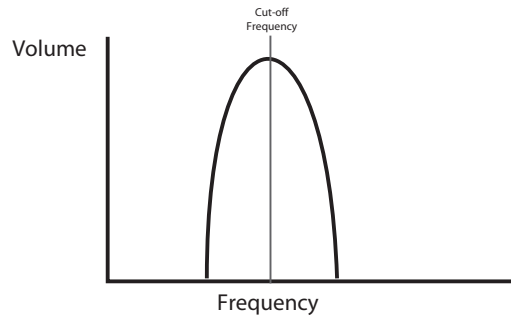

Envelopes And Amplifier

In earlier paragraphs, the synthesis of the pitch and the timbre of a sound was described. The next part of the Synthesis Tutorial describes how the volume of the sound is controlled. The volume of a note created by a musical instrument often varies greatly over the duration of the note, according to the type of instrument.

For example, a note played on an Organ quickly attains full volume when a key is pressed. It stays at full volume until the key is released, at which point the volume level falls instantly to zero.

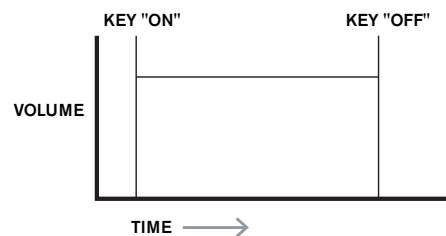

A Piano note quickly attains full volume after a key is pressed, and gradually falls in volume to zero after several seconds, even if the key is held.

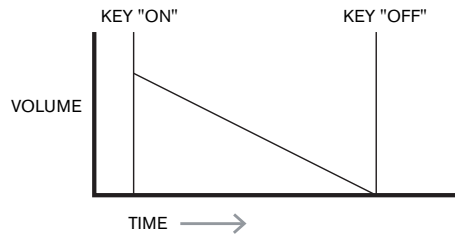

A String Section emulation only attains full volume gradually when a key is pressed. It remains at full volume while the key is held down, but once the key is released, the volume falls to zero fairly slowly.

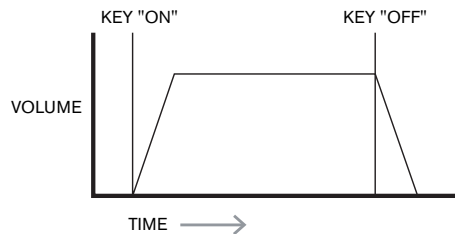

In an analogue synthesizer, changes to a sound's character which occur over the duration of a note are controlled by a section called an Envelope Generator. Bass Station II has two Envelope Generators; one (Amp Env) is always related to the Amplifier, which controls the note's amplitude - i.e., the volume of the sound - when the note is played. Each envelope generator has four main controls, which are used to adjust the shape of the envelope (often referred to as the ADSR parameters).

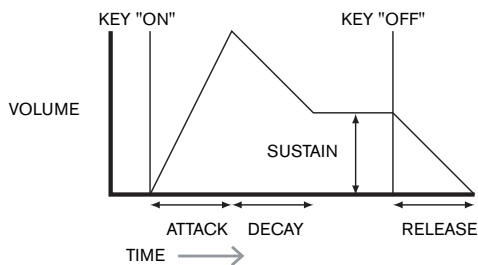

Attack Time

Adjusts the time it takes after a key is pressed for the volume to climb from zero to full volume. It can be used to create a sound with a slow fade-in.

Decay Time

Adjusts the time it takes for the volume to fall from its initial full volume to the level set by the Sustain control while a key is held down.

Sustain Level

This is unlike the other Envelope controls in that it sets a level rather than a period of time. It sets the volume level that the envelope remains at while the key is held down, after the Decay Time has expired.

Release Time

Adjusts the time it takes for the volume to fall from the Sustain level to zero once the key is released. It can be used to create sounds that have a "fade-out" quality.

Most synthesizers can generate multiple envelopes. One envelope is always applied to the amplifier to shape the volume of each note played, as detailed above. Additional envelopes can be used to dynamically alter other sections of the synthesizer during the lifetime of each note. Bass Station II's second Envelope Generator (**Mod Env**) can be used to modify the filter cut-off frequency, or the pulse width of the Oscillators' Square Wave outputs.

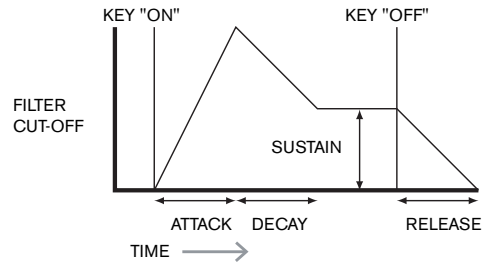

LFOs

Like the Envelope Generators, the LFO section of a synthesizer is a Modulator. Thus instead of being a part of the sound synthesis itself, it is used to change (or modulate) other sections of the synthesizer. In Bass Station II, for example, the LFOs can be used to alter Oscillator pitch, or Filter cutoff frequency.

Most musical instruments produce sounds that vary over time both in volume and in pitch and timbre. Sometimes these variations can be quite subtle, but still contribute greatly towards characterising the final sound.

Whereas an Envelope is used to control a one-off modulation over during the lifetime of a single note, LFOs modulate by using a repeating cyclic waveform or pattern. As discussed earlier, Oscillators produce a constant waveform, which can take the shape of a repeating sine wave, triangle wave etc. LFOs produce waveforms in a similar way, but normally at a frequency which is too low to produce a sound that the human ear could perceive directly. (LFO stands for Low Frequency Oscillator.) As with an Envelope, the waveforms generated by the LFOs may be fed to other parts of the synthesizer to create the desired changes over time - or 'movements' - to the sound. Bass Station II has two independent LFOs, which may be used to modulate different synthesizer sections and can run at different speeds.

Imagine this very low frequency wave being applied to an Oscillator's pitch. The result is that the pitch of the Oscillator slowly rises and falls above and below its original pitch. This would simulate, for example, a violinist moving a finger up and down the string of the instrument whilst it is being bowed. This subtle up and down movement of pitch is referred to as the 'Vibrato' effect.

A waveshape often used for an LFO is a Triangle wave.

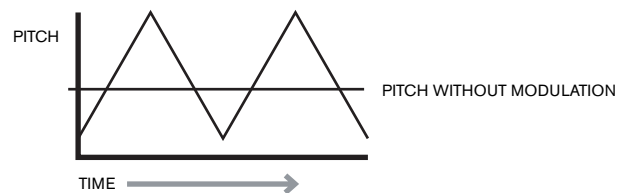

Alternatively, if the same LFO signal were to modulate the Filter cut-off frequency instead of the Oscillator pitch, a familiar wobbling effect known as 'wah-wah' would be the result.

Summary

A synthesizer can be broken down into five main sound generating or sound modifying (modulating) blocks:

1. Oscillators that generate waveforms at a various pitches.
2. A Mixer that mixes the outputs from the Oscillators together (and add Noise and other signals).
3. Filters that remove certain harmonics, changing the character or timbre of the sound.
4. An Amplifier controlled by an Envelope generator, which alters the volume of a sound over time when a note is played.
5. LFOs and Envelopes that can be used to modulate any of the above.

Much of the enjoyment to be had with a synthesizer is with experimenting with the factory preset sounds (Patches) and creating new ones. There is no substitute for 'hands on' experience. Experiments with adjusting Bass Station II's various controls will eventually lead to a fuller understanding of how the various synth sections alter and help shape new sounds. Armed with the knowledge in this chapter, and an understanding of what is actually happening in the synth when tweaks to the knobs and switches are made, the process of creating new and exciting sounds will become easy. Have fun!

SIMPLIFIED BASS STATION II BLOCK DIAGRAM

Bass Station II Block diagram

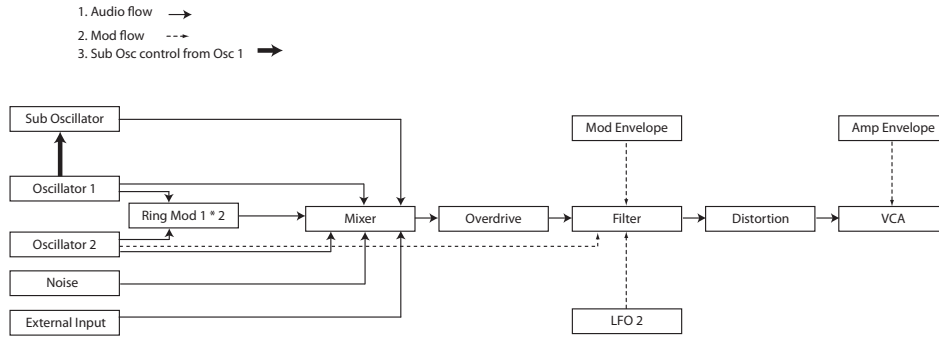

Oscillator modulation controls

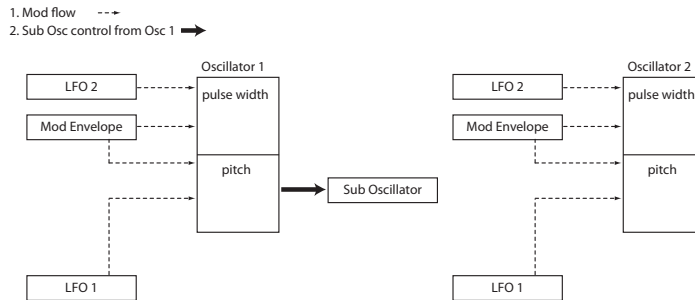

BASS STATION II IN DETAIL

The Oscillator Section

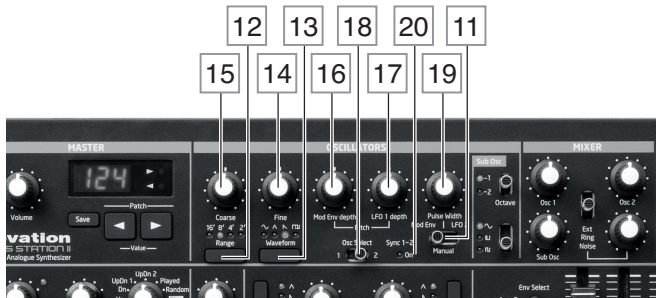

Bass Station II's Oscillator section consists of two identical primary oscillators, plus a "sub-octave" oscillator which is always frequency-locked to Oscillator 1. The primary oscillators, Osc 1 and Osc 2, share a single set of controls; the oscillator being controlled is selected by the **Oscillator** switch [11]. After adjustments have been made to one oscillator, the other may be selected and the same controls used to adjust its contribution to the overall sound, without altering the settings of the first. You can constantly reassign the controls between the two oscillators until you get the sound you're after.

The following descriptions thus apply equally to the two oscillators, depending which is currently selected:

Waveform

The Waveform switch [13] selects one of four fundamental wave shapes - ~ Sine, ^ Triangle, / (rising) Sawtooth or □ Square/Pulse. The LEDs above the switch confirm the waveform currently selected.

Pitch

The three controls **Range** [12], **Coarse** [14] and **Fine** [15] set the Oscillator's fundamental frequency (or Pitch). The **Range** switch is calibrated in traditional "organ-stop" units,

where 16' gives the lowest frequencies and 2' the highest. Each doubling of stop length halves the frequency and thus transposes the keyboard pitch down one octave. When Range is set to 8', the keyboard will be at concert pitch with Middle C in the centre. (Note that Oscillator range setting is completely independent of the keyboard's Octave Shift function, set with the Octave buttons [3]).

The Coarse and Fine rotary controls adjust the pitch over a range of ±1 octave and ±1 semitone respectively. The LED display shows the number of semitones above or below concert pitch as Coarse is adjusted. When Fine is adjusted, the display shows the variation above or below concert pitch in cents, where 1 cent = 1/100 of a semitone.

Modulation

The frequency of either Oscillator may be varied by modulating it with either (or both) LFO 1 or the Mod Env envelope. The two Pitch controls, **LFO 1 depth** [17] and **Mod Env depth** [16] control the depth - or intensity - of the respective modulation sources.

Note that only one LFO - LFO 1 - is used for oscillator modulation. Oscillator pitch can be varied by up to five octaves, but the LFO 1 depth control is calibrated to give finer resolution at lower parameter values (less than ±12), as these are generally more useful for musical purposes.



You will find the following parameter settings generate musically useful pitch swings:
6 = a semitone 12 = a tone 22 = a perfect fifth
32 = one octave 56 = two octaves 80 = three octaves

Negative values of **LFO 1 depth** "invert" the modulating LFO waveform; the effect of this will be more obvious with non-sinusoidal LFO waveforms.

Adding LFO Modulation can add a pleasing vibrato when a sine or triangle LFO waveform is used, and the LFO speed is set neither too high nor too low. A sawtooth or square LFO waveform will produce rather more dramatic and unusual effects.

Adding envelope modulation can give some interesting effects, with the oscillator pitch altering over the duration of the note as it is played. The control is "centre-off", the LED display shows a range of -63 to +63 as it is adjusted. With the parameter value set to maximum, the oscillator pitch will vary over eight octaves. A parameter value of 8 shifts the pitch of the oscillator by one octave for the maximum level of the modulation envelope

(e.g., if sustain is at maximum). Negative values invert the sense of the pitch variation; i.e., the pitch will fall during the attack phase of the envelope if **Mod Env depth** has a negative setting.

Pulse Width

When the Oscillator waveform is set to Square/Pulse, the timbre of the "edgy" square wave sound can be modified by varying the pulse width, or duty cycle, of the waveform.

The Pulse Width modulation source switch [18] allows the duty cycle to be varied either manually or automatically. When set to **Manual**, the **Pulse Width** control [19] is enabled; the parameter range is 5 to 95, where 50 corresponds to a square wave (a duty cycle of 50%). Extreme clockwise and anticlockwise settings produce very narrow positive or negative pulses, with the sound becoming thinner and more "reedy" as the control is advanced.

Pulse width may also be modulated by either (or both) the Modulation Envelope or LFO 2, by moving switch [18] to one of its other positions. The sonic effect of LFO modulation on pulse width is very dependent on the LFO waveform and speed used, while using envelope modulation can produce some good tonal effects, with the harmonic content of the note changing over its duration.

Oscillator Sync

Oscillator Sync is a technique of using one oscillator (Osc 1 on Bass Station II) to add additional harmonics to the waveform produced another (Osc 2), by making the waveform from Osc 1 "retrigger" that of Osc 2 before a full cycle of Osc 2's waveform has been completed. This produces an interesting range of sonic effects, the nature of which varies as the frequency of Osc 1 is altered, and is also dependent on the ratio of the two oscillators' frequencies, as the additional harmonics may or may not be musically related to the fundamental frequency. The diagrams below illustrate the process.

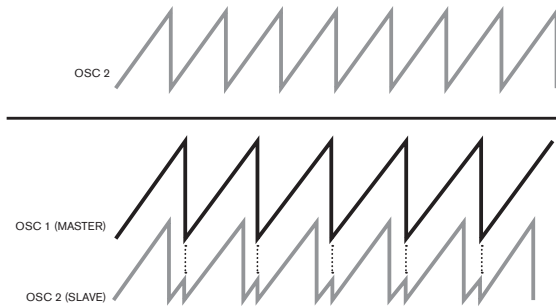

In general, it is advisable to turn down the volume of Osc 1 in the Mixer section [26] so that you don't hear its effect. Osc Sync is enabled by an On-Key function – **Oscillator: Osc 1-2 sync** (the higher D). The **Sync 1-2 LED** [20] illuminates when **Osc 1-2 sync** is selected.

The Sub Oscillator

In addition to the two primary oscillators, Bass Station II has a secondary "sub-octave" oscillator, whose output can be added to that of Osc 1 and Osc 2 to create great bass sounds. The sub oscillator's frequency is always locked to that of Osc 1, so that the pitch is either exactly one or two octaves below it, according to the setting of the **Sub Oscillator Octave** switch [21].

The waveform of the sub oscillator is selectable independently of Osc 1, with the **Wave** switch [22]. The options are: a narrow pulse wave or a square wave.

Both the sub oscillator switches have associated sets of LEDs to confirm the current setting. The sub oscillator output is fed to the Mixer Section where it may be added to the synth sound to the degree required.

The Mixer Section

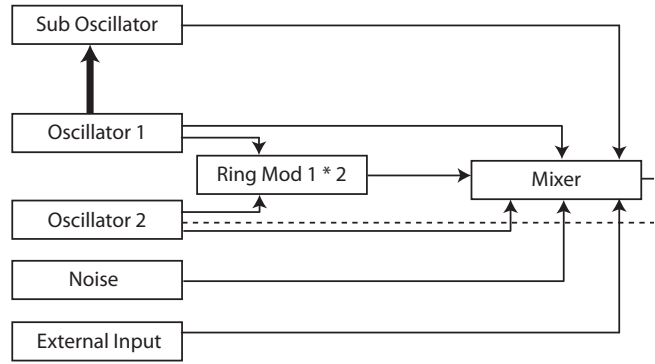
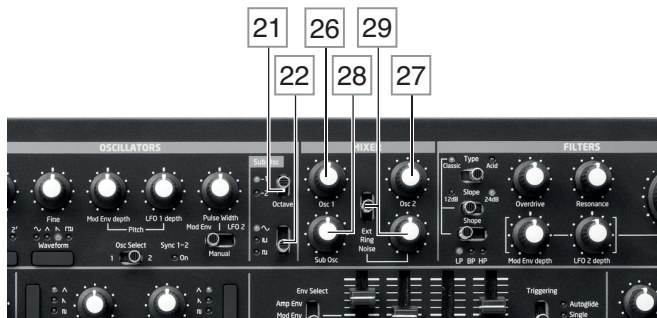

The outputs of the various sound sources can be mixed together in various proportions to produce the overall synth sound, using what is essentially a standard 6-into-1 mono mixer.

The two Oscillators and the sub oscillator have dedicated, fixed level controls, **Osc 1** [26], **Osc 2** [27] and **Sub** [28]. The other three sources – the Noise source, Ring Modulator output and external input – "share" a single level control, though any mix of the three may be used. The **Noise/Ring/Ext** switch [30] assigns the fourth level control [29] to one of these three sources at a time; having set the level in the mix for one of them, you can move switch [30] to a different position and add that source to the mix without altering the level of the first.

The Filter Section

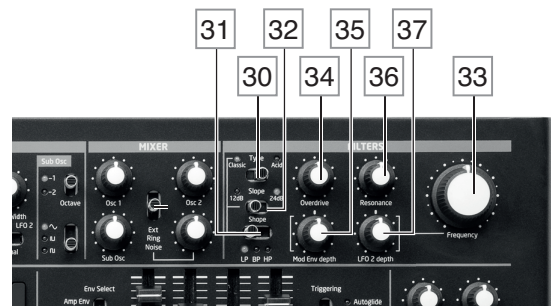

The sum created in the mixer from the various signal sources is fed to the Filter Section. Bass Station II's filter section is both simple and traditional, and can be configured with only a small number of single-function controls.

Filter type

The **Type** switch [31] selects one of two filter styles: **Classic** and **Acid**.

Acid configures the filter section as a fixed-slope, 4-pole (24 dB/oct), low-pass type. Low-pass filters reject higher frequencies, so this filter setting will be suitable for many types of bass sounds. This filter type is based on the simple diode-ladder designs that were found in various analogue synths popular in the 1980s, and has a particular sonic character. When the **Acid** filter is selected, the **Slope** and **Shape** switches are inoperative.

When **Type** is set to **Classic**, the filter is configured as a variable type, whose **Shape** and **Slope** may be set with the switches [32] and [33] respectively. A low-pass (**LP**), band-pass (**BP**) or hi-pass (**HP**) characteristic may be selected with **Shape**; **Slope** sets the degree of rejection applied to out-of-band frequencies; the **24 dB** position gives a steeper slope than the **12 dB**; an out-of-band frequency will be attenuated more severely with the steeper setting.

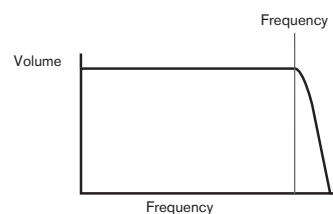

Low Pass 24 dB (Classic / Acid)

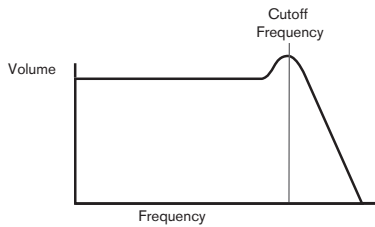

Low Pass 12 dB

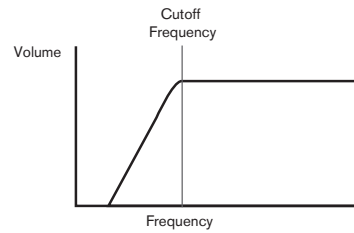

High Pass 12 dB

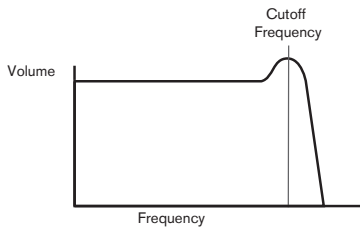

Low Pass 24 dB (Classic / Acid) with resonance

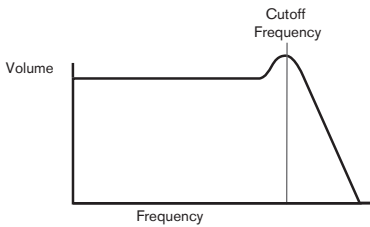

Low Pass 12 dB with resonance

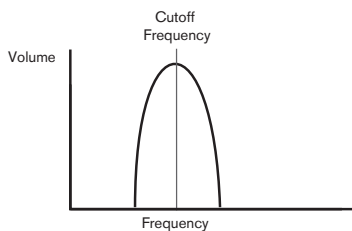

Band Pass 24 dB

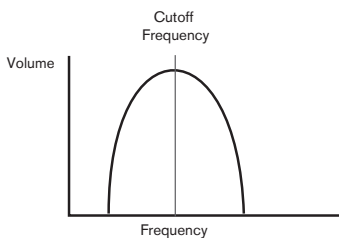

Band Pass 12 dB

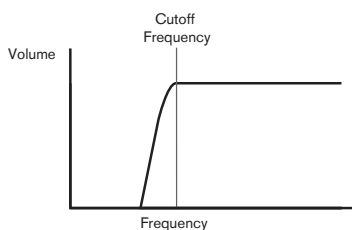

High Pass 24 dB

Frequency

The large rotary **Frequency** control [34] sets the cut-off frequency of the **Acid** filter type, and also of the **Classic** filter type when **Shape** is set to **HP** or **LP**. With a Classic band-pass filter configured, **Frequency** sets the centre frequency of the pass-band.

Sweeping the filter frequency manually will impose a "hard-to-soft" characteristic on almost any sound.

Resonance

The **Resonance** control [35] adds gain to the signal in a narrow band of frequencies around the frequency set by the **Frequency** control. It can accentuate the swept-filter effect considerably. Increasing the resonance parameter is very good for enhancing modulation of the cut-off frequency, creating a very edgy sound. Increasing **Resonance** also accentuates the action of the **Frequency** control, giving it a more pronounced effect.

Filter modulation

The filter's Frequency parameter may be varied automatically - or modulated, by the output of LFO 2 and/or the Modulation Envelope. Either or both methods of modulation may be used, and each has a dedicated intensity control, **LFO 2 depth** [38] for LFO 2 and **Mod Env depth** [37] for the modulation envelope. (Compare with the use of LFO 1 and Mod Env for modulating the Oscillators.)

Note that only one LFO - LFO 2 - is used for filter modulation. Filter frequency can be varied by up to eight octaves.



Some examples of the relationship between the LFO 2 Depth parameter and the filter frequency are as follows:

- 1 = 76 cents
- 16 = one octave
- 32 = two octaves

Negative values of **LFO 2 depth** "invert" the modulating LFO waveform; the effect of this will be more obvious with non-sinusoidal LFO waveforms.

Modulating the filter frequency with an LFO can produce some unusual "wah-wah" type effects. Setting LFO 2 to a very slow speed can add a gradual hardening and then softening edge to the sound.

When the filter's action is triggered by Envelope 2, the filter action changes over the duration of the note. By adjusting the Envelope controls carefully, this can produce some very pleasing sounds, as for example, the spectral content of the sound can be made to differ considerably during the attack phase of the note compared to its "fade-out". **Mod Env depth** lets you control the "depth" and "direction" of the modulation; the higher the value, the greater the range of frequencies over which the filter will sweep. With the parameter set to its maximum value, the filter frequency will vary over a range of eight octaves when Envelope 2 Sustain is set to maximum. Positive and negative values make the filter sweep in opposite directions, but the audible result of this will be further modified by the filter type in use.

Overdrive

The filter section includes a dedicated drive (or distortion) generator; the **Overdrive** control [36] adjusts the degree of distortion treatment applied to the signal. The drive is added before the filter.

The Envelopes Section

Bass Station II generates two envelopes each time a key is pressed, which can be used to modify the synth sound in various ways. The envelope controls are based on the familiar ADSR concept.

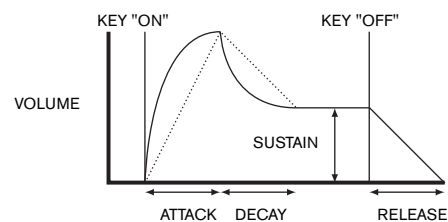

The ADSR envelope can be most easily visualised by considering the amplitude (volume) of a note over time. The envelope describing the "lifetime" of a note can be split into four distinct phases:

- **Attack** – the time it takes for the note to increase from zero (e.g., when the key is pressed) to its maximum level. A long attack time produces a "fade-in" effect.
- **Decay** – the time it takes for the note to drop in level from the maximum value reached at the end of the attack phase to a new level, defined by the Sustain parameter.
- **Sustain** – this is an amplitude value, and represents the volume of the note after the initial attack and decay phases – i.e., while holding the key down. Setting a low value of Sustain can give a very short, percussive effect (providing the attack and decay times are short).
- **Release** – This is the time it takes for the note's volume to drop back to zero after the key is released. A high value of Release will cause the sound to remain audible (though diminishing in volume) after the key is released.

Although the above discusses ADSR in terms of volume, note that Bass Station II is equipped with two separate envelope generators, referred to as **Amp Env** and **Mod Env**.

Amp Env - the amplitude envelope - is the envelope that controls the amplitude of the synth signal, and is always routed just to the VCA in the output stage (see the Bass Station II block diagram on page 12).

Mod Env – the modulation envelope - is routed to various other sections of Bass Station II, where it can be used to alter other synth parameters over the duration of the note. These are:

- Modulating the pitch of Osc 1 and Osc 2, at a degree set by the **Mod Env depth** control [16]
- Modulating the pulse width of Osc 1 and Osc 2's outputs when they are set to Square/Pulse waveforms and the Pulse Width modulation source switch [18] is set to Mod Env
- Modulating the filter frequency (when the filter is in Classic mode), at a degree set by the **Mod Env depth** control [37]

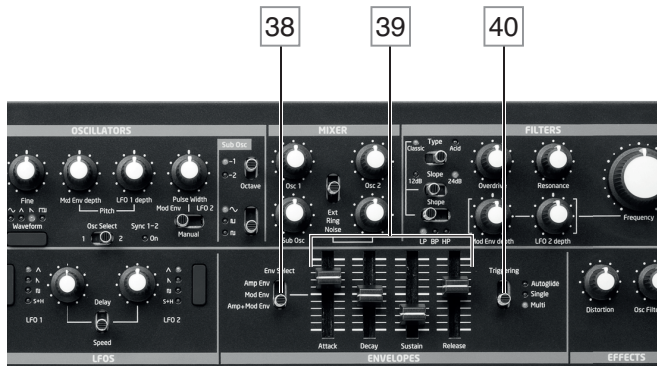

Bass Station II has a dedicated slider control for each ADSR parameter. The set of sliders will adjust the envelope(s) selected by the Env Select switch [40]: the amplitude envelope, the modulation envelope, or both together.

- **Attack** - sets the note's attack time. With the slider at its lowest position, the note attains its maximum level immediately the key is pressed; with the slider in its uppermost position, the note takes over 5 seconds to reach its maximum level. Midway, the time is approx. 250 ms.
- **Decay** - sets the time the note takes to decay from its initial level to that defined by the Sustain parameter. With the slider at the mid-position, the time is approx. 150 ms.
- **Sustain** - sets the volume of the note after the decay phase. A low Sustain value will obviously have the effect of emphasising the start of the note; having the slider fully down will make the note inaudible when the decay time has elapsed.
- **Release** - Many sounds acquire some of their character from the notes remaining audible after the key is released; this "hanging" or "fade-out" effect, with the note gently dying away naturally (as with many real instruments) can be very effective. With the slider set to the mid-position the Release Time will be approx. 360 ms. Bass Station II has a maximum release time of over 10 seconds, but shorter times will probably be more useful! The relationship between the parameter value and the Release Time is not linear.

Further control over how individual notes sound with different playing styles can be obtained with the different settings of the **Triggering** switch [41].

- **Single** – the selected envelope(s) is triggered for every note that is played on its own. However, if playing in a legato style then the envelope(s) will not trigger. If the **Glide Time** control [46] is set to anything other than fully anti-clockwise (off), portamento is applied between the notes irrespective of playing style. See "Portamento" on page 15.
- **Multi** – the selected envelope(s) is always triggered for every note played,

regardless of playing style. If the **Glide Time** control [46] is set to anything other than fully anti-clockwise (off) portamento is applied between the notes, whether they are played in a legato style or not.

- **Autoglide** – this mode works in the same way as **Single**, but portamento is applied only to those notes played in a legato style.



What is Legato?

As implied above, the musical term Legato means "smoothly". A Legato keyboard style is one where at least two notes overlap. This means that as you play the melody, you keep the previous (or an earlier) note sounding as you play another note. Once that note is sounding, you then release the earlier note.

Legato style playing is relevant to some sonic possibilities. In the case of **Multi** mode, it is important to appreciate that the envelope will re-trigger if any 'gap' is left between notes.

Portamento

Portamento makes notes sequentially glide from one to the next as they are played, rather than immediately jumping from one pitch to another. The synth remembers the last note played and the glide will start from that note even after the key has been released. The duration of the glide is set by the **Glide Time** control.

The Effects Section

Two additional sound effects tools are provided with Bass Station II: Distortion and Osc Filter Mod.



- **Distortion** - this adds a controlled amount of distortion before the VCA. This means that the distortion characteristic will not change as the amplitude of the signal changes over time as a result of the Amplitude Envelope.
- **Osc Filter Mod** – This allows the filter frequency to be modulated directly by Oscillator 2. The intensity of the resulting effect is dependent on the control setting, but also almost all Osc 2 parameters, e.g., range, pitch, waveform, pulse width and any modulation applied.



Try adding Osc Filter Mod while sweeping Osc 2 pitch with the pitch wheel.

The LFO Section

Bass Station II has two separate Low Frequency Oscillators (LFOs), designated LFO 1, and LFO 2. They are identical in terms of features, but their outputs are routed to different parts of the synth and are thus used differently, as outlined below:

LFO 1:

- can modulate the pitch of Osc 1 and/or Osc 2; the amount of modulation is adjusted in the Oscillator Section with the **LFO 1 depth** control [17].
- can modulate the pitch of both Osc 1 and Osc 2 via the Mod wheel [2], if enabled by the On-Key function **Mod Wh: LFO 1 to Osc Pitch** (lower C#).
- can modulate the pitch of both Osc 1 and Osc 2 via keyboard aftertouch, if enabled by the On-Key function **Aftertouch: LFO 1 to Osc Pitch** (lower F).

LFO 2:

- can modulate the pulse width of Osc 1 and/or Osc 2 when **Waveform** [13] is set to Square/Pulse, and the pulse width modulation source switch [18] is set to **LFO 2**.
- can modulate the filter frequency; the amount of modulation is adjusted in the Filter Section with **LFO 2 depth** control [38].
- can modulate the filter frequency via the Mod wheel [2], if enabled by the On-Key function **Mod Wh: LFO 2 to Filter Freq** (lower D).

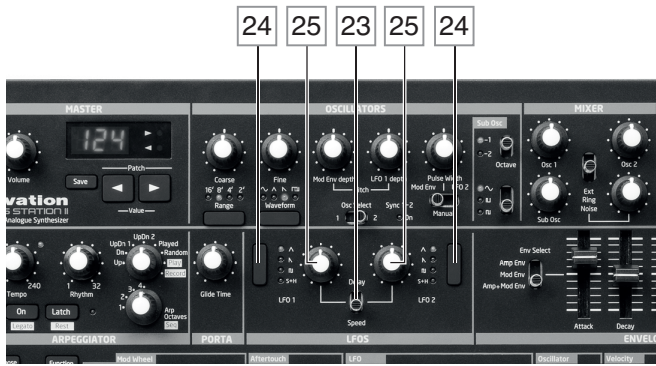

LFO Waveforms

The waveform switches **24** select one of four wave shapes - Triangle, (falling) Sawtooth, Square or Sample and Hold. The LEDs next to the switch confirm the waveform currently selected.

LFO Speed

The speed (or frequency) of each LFO is set by the rotary controls **25** when the LFO **Delay/Speed** switch **23** is set to Speed. The frequency range is from zero to about 190 Hz.

LFO Delay

Vibrato is often more effective when faded-in, rather than just 'switched on'; the **Delay** parameter sets how long the LFO output takes to ramp up when a note is played. The single (one per LFO) rotary control **25** is used to adjust this time when the **LFO Delay/Speed** switch **23** is in the **Delay** position.

LFO Speed/Sync

These On-Key functions (available for each LFO independently) relate to the **Delay/Speed** switch **23** in the **LFO** section of the Bass Station II. When **Delay/Speed** is set to **Speed**, it is possible to extend its function by using the **Speed/Sync** On-Key function. Setting the On-key function **Speed/Sync LFO 1** (via the lower A key) to **SPD** (Speed) allows the speed of LFO 1 to be controlled by the rotary control **25**. Setting it to **Sync** (Sync) reassigns the function of this control, and allows the speed of LFO 1 to be synchronised to an internal or external MIDI clock, based on a sync value selected by the control **25**. Sync values are shown on the LED display. See Sync Values table on page 19.

The same facility is applicable to LFO 2 by the On-Key function **Speed/Sync LFO 2**, which is selected by the lower A# key.

LFO Keysync

Each LFO runs continuously, 'in the background'. If **Keysync** is **Off**, there is no way of predicting where the waveform will be when a key is pressed. Consecutive presses of a key will produce varying results. Setting **Keysync** to **On** re-starts the LFO at the start of the waveform every time a key is pressed.

Keysync is selected on or off for each LFO independently by On-Key functions: **LFO: Keysync LFO 1** (lower G) and **LFO: Keysync LFO 2** (lower G#).

LFO Slew

Slew has the effect of modifying the shape of the LFO waveform. Sharp edges become less sharp as Slew is increased. The effect of this can be heard by selecting Square as the LFO waveform and setting the rate fairly low so that the output when a key is pressed alternates between just two tones. Increasing the value of Slew will cause the transition between the two tones to become a "glide" rather than a sharp change. This is caused by the vertical edges of the square LFO waveform being slewed.

Slew is controlled by On-Key functions: **LFO: Slew LFO 1** (lower B) and **LFO: Slew LFO 2** (middle C). Press the **Function/Exit** button **5** and the chosen Slew LFO key; then adjust the parameter value using the **Value** buttons **8**. Press **Function/Exit** again to exit LFO Slew.



Note that Slew has an effect on all LFO waveforms, but the effect differs somewhat between waveforms. As Slew is increased, the time taken to reach maximum amplitude is increased, and can ultimately result in it never being achieved at all, though the setting at which this point is reached will vary with waveform.

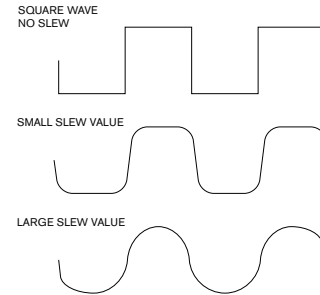

The Arpeggiator Section

Bass Station II has a versatile Arpeggiator feature which allows arpeggios of varying complexity and rhythm to be played and manipulated in real-time. When the Arpeggiator is enabled and a single key is pressed, its note will be retrIGGERED. If you play a chord, the Arpeggiator identifies its notes and plays them individually in sequence (this is termed an arpeggio pattern or 'arp sequence'); thus if you play a C major triad, the selected notes will be C, E and G.



The Arpeggiator is enabled by pressing the **On** button **42**; the associated LED will confirm its status.

The tempo of the arp sequence is set by the **Tempo** control **44**; you can make the sequence play faster or slower by adjusting this. The range is 40 to 240 BPM, and the BPM value is shown in the LED display. If Bass Station II is being synchronised to an external MIDI clock, it will automatically detect the incoming clock and disable the Tempo control. The tempo of the arp sequence will now be determined by the external MIDI clock. To view the BPM value of the incoming clock, adjust the Tempo control slightly; this will change the LED display to show the external clock rate.



If the external MIDI clock source is removed, the Arpeggiator will continue to "flywheel" at the last known tempo. However, if you now adjust the **Tempo** control, the internal clock will take over and override the flywheel rate. The arp tempo is now governed by the internal clock and adjustable by the Tempo control.

The **Latch** button **43** plays the currently selected arp sequence repeatedly without the keys being held. **Latch** can also be pressed before the Arpeggiator is enabled. When the Arpeggiator is enabled, Bass Station II will immediately play the arp sequence defined by the last set of notes played, and will do so indefinitely.

The arp pattern is selected by the three controls **45**, **46** & **47**: **Rhythm**, **Arp Mode** and **Arp Octaves**.

- **Rhythm** – the arpeggiator comes with 32 pre-defined arp sequences; use the **Rhythm** control to select one. The sequences are numbered 1 to 32; the display confirms the number of the one selected. The sequences increase in rhythmic complexity as the numbers increase; Rhythm 1 is just a series of consecutive crotchets, and higher-numbered rhythms introduce more complex patterns and shorter duration notes (semiquavers).
- **Arp Mode** – the setting of this 8-position switch roughly determines the order in which the notes making up the sequence will be played:

SWITCH POSITION	DESCRIPTION	COMMENTS
Up	Ascending	Sequence begins with lowest note played
Down	Descending	Sequence begins with highest note played
UpDn	Ascend/descend	Sequence alternates
UpDn2		As UpDn, but lowest and highest notes are played twice
Played	Key order	Sequence comprises notes in the order in which they are played
Random	Random	The notes held are played in a continuously-varying random sequence
Record		See Sequencer section (page 17)
Play		



You should spend some time experimenting with different combinations of Rhythm and Arp Mode. Some patterns work better in certain Modes.

- **Arp Octaves** – allows upper octaves to be added to the arp sequence. When set to 2, the sequence is played as normal, then immediately played again an octave higher. Higher values extend this process by adding additional higher octaves. Settings other than 1 have the effect of doubling, tripling, etc., the length of the sequence. The additional notes added duplicate the complete original sequence, but octave-shifted. Thus a four-note sequence played with **Arp Octaves** set to 1 will consist of eight notes when **Arp Octaves** is set to 2.

Arp Swing

This arp parameter is set via a On-Key function, **Arp: Swing** (upper F#). Hold the key down and adjust the parameter value with the **Patch/Value** buttons [8]. If Swing is set to something other than its default value of 50, some further interesting rhythmic effects can be obtained. Higher values lengthen the interval between odd and even notes, while the even-to-odd intervals are correspondingly shortened. Lower values have the opposite effect. This is an effect which is easier to experiment with than describe!

The Sequencer

Bass Station II includes a 32 note step sequencer, the controls for which are included in the Arpeggiator section. The sequencer controls are marked on the control panel by black text on a white-block background, and are: **Record**, **Play**, **SEQ**, **Legato**, **Rest** and **SEQ Retrig**. (Note that **SEQ**, **Legato** and **Rest** are "second functions" of the **Arp Octaves** control [46] and the arp **On** [41] and **Latch** [42] buttons respectively.)

Record

Up to four separate sequences, each containing up to 32 notes (or a combination of notes and rests) can be recorded. These sequences are stored in Bass Station II and are retained when the synth is switched off. In addition, the currently selected sequence is also stored as part of a patch.

To record a sequence, first select which of the four memory locations (1 to 4) is to be used with the **SEQ** control [46]. Set the Arp Mode control [45] to **Record**. The LED display will confirm the mode with REC. Play the first note (or insert a rest – see below) and the LED display will show '1'; it will then increment with each subsequent note/rest that is played, up to a maximum of 32 notes.

Note that:

the sequencer does not record the length of the notes or rests played. During playback the rhythm of the sequence is determined by the arp Rhythm control [44]; if a complete sequence of 32 notes/rests has been recorded any subsequent note played will not be stored; sequences may be shorter than 32 notes/rests if wished and you can stop recording at any time.

A rest (a period of silence of the same duration as a note) can be recorded into a sequence in the same manner as recording a note by pressing the **Rest** button [41].

If two or more notes are required to be played in a legato fashion (irrespective of the pattern selected by the **Rhythm** control), play the first note and then press the **Legato** button [41]. A dash '-' will appear in the display after the step number to indicate that legato has been applied to this note. This, and the following note, will now be played in a legato style. Similarly, notes can be tied (extended in duration) in a similar manner by playing the same note either side of the legato dash '-'. (Note that it is not possible to tie rests in this way.)

Pressing the Legato button repeatedly will toggle the legato/tie function on and off. Use this to cancel any applied legato/tie to a sequencer step. Once cancelled the dash will disappear.

Play

Once the desired sequence is recorded, set the Arp Mode control to **PLAY**.

Recorded sequences can be played in a number of ways. If you play the first note of the recorded sequence, the sequencer will play the entire sequence in its original key. For example, if the first note of the recorded sequence was Middle C, then to play that sequence back in its original key you should play Middle C. If you play a different key, the sequence will be transposed, with the key played as the first note of the sequence. For example, if the lower B is played, the sequence (which was recorded starting on Middle C) will be transposed down one semitone.

The rhythm of the sequence can be changed by using the **Rhythm** control [45] in a similar manner as used in with the arpeggiator.

SEQ Retrig

This sequence parameter is set via an On-Key function, **Arp: SEQ Retrig** (the upper G).

The available rhythms - as described in the arpeggiator section - range from two bars of single crotchet beats to two bars with a complex pattern of semiquaver beats. The number of notes in the rhythm pattern therefore varies from 8 (two bars each of four crotchets) to 32 (two bars each of 16 semiquavers/rests). However, a recorded sequence could contain any number of notes (up to a maximum of 32), thus the length of the sequence may not match the length of the selected rhythm pattern. This may be fine, but in some instances it may be better to shorten the sequence to match the length of the selected rhythm, i.e., to have a repetitive sequence matching the rhythm.

When set to On, SEQ Retrig re-triggers the sequence every two bars, irrespective of whether playback of the entire sequence has been completed. With **SEQ Retrig** set to **Off**, the sequence will be played in its entirety, even if it 'wraps around' the rhythm pattern.

On-key Functions

To minimise the number of controls, Bass Station II uses On-key functions to adjust non-performance sound parameters.

Each note on the keyboard has a specific On-key function, and these are marked on the panel above each key. To use an On-key function press and hold the **Function/Exit** button [51] and press the key corresponding to the desired function. The LED display will flash, showing the current value or setting of the function. Release both the key and the **Function/Exit** button, and use the **Patch/Value** buttons [8] to alter the value or state. Note that some functions are "switch" type - i.e., On/Off, while others are "analogue" and have a typical parameter value range from -63 to +63. When the desired value or state has been set, press **Function/Exit** again to exit the On-key mode; if you don't make any further adjustments it will time-out after 10 seconds.



Once the On-key function has been selected (with the LED display flashing), the keyboard resumes normal operation. This allows any changes to the sound resulting from alteration of the On-key function to be auditioned live if necessary. For example, changing the Arp Swing parameter in a live performance.

Many of the On-key functions are described elsewhere in the manual; the list below provides a full summary.

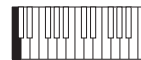

Mod Wh: Filter Freq (bottom C)

Range: -63 to +63

As well as varying the filter cut-off frequency manually (with the **Frequency** control [33]), with the Modulation Envelope, and with LFO 2, you can also use the Mod Wheel to vary it. This is great feature in live performance. The parameter value effectively determines the range of control available from the wheel. Positive values of the parameter increase the filter cut-off frequency as the mod wheel is moved away from you; negative values have the opposite effect.

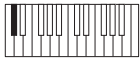

Mod Wh: LFO 1 to OSC Pitch (lower C#)

Range: -63 to +63

The **LFO 1 to OSC Pitch** parameter controls the degree to which the oscillator pitch (both Osc 1 and Osc 2) is modified by LFO 1 when using the Mod wheel [2]. This function is summed with all other oscillator pitch controls, therefore its specific effect will also depend on the other oscillator pitch control settings. Positive values increase the modulation, resulting in a maximum pitch change of 96 semitones, or 8 octaves. Negative values reduce the oscillator pitch modulation by a similar maximum amount.

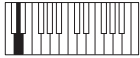

Mod Wh: LFO 2 to Filter Freq (lower D)

Range: -63 to +63

The **LFO 2 to Filter Freq** parameter controls the degree to which the filter frequency is modified by LFO 2 when using the Mod wheel [2]. This function is summed with all other filter frequency controls, therefore its specific effect will also depend on the other filter frequency control settings. Positive values increase the filter frequency modulation, negative values decrease it.



Mod Wh: Osc 2 Pitch (lower D#)

Range: -63 to +63

The **Osc 2 Pitch parameter** controls the degree to which the pitch of Osc 2 is modified when using the Mod wheel [2]. This is useful for sweeping Osc 2 by a greater amount than is possible using the Pitch wheel. Positive values increase the modulation, resulting in a maximum pitch change of 96 semitones, or 8 octaves. Negative values reduce the oscillator pitch modulation by a similar maximum amount.

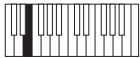

Aftertouch: Filter Freq (lower E)

Range: -63 to +63

The **Filter Freq parameter** controls the degree to which the filter frequency is modified by aftertouch (i.e., the change in filter frequency is proportional to the amount of pressure applied to the key once it is struck). Positive values increase the filter frequency modulation, negative values decrease it.



Aftertouch: LFO 1 to OSC Pitch (lower F)

Range: -63 to +63

The **LFO 1 to OSC Pitch** parameter controls the degree to which the oscillator pitch (for both Osc 1 and Osc 2) is modified by LFO 1 when using aftertouch. This function is summed with the other oscillator pitch controls, therefore its specific effect will also depend on the other oscillator pitch control settings. Positive values increase the modulation, resulting in a maximum pitch change of 95 semitones, or 8 octaves. Negative values reduce the oscillator pitch modulation by a similar maximum amount.



Aftertouch: LFO 2 Speed (lower F#)

Range: -63 to +63

The **LFO 2 Speed parameter** controls the degree to which aftertouch affects LFO 2 speed. Positive values increase the speed in proportion to the amount of pressure applied to the key. Negative values decrease the speed of LFO 2.



LFO: Keysync LFO 1 (lower G)

Range: ON or OFF

Setting **Keysync LFO 1** to On re-starts LFO 1 at the start of the waveform every time a key is pressed. If set to Off it is not possible to predict where the waveform will be when a key is pressed.



LFO: Keysync LFO 2 (lower G#)

Range: ON or OFF

Setting **Keysync LFO 2** to On re-starts LFO 2 at the start of the waveform every time a key is pressed. If set to Off it is not possible to predict where the waveform will be when a key is pressed.



LFO: Speed/Sync LFO 1 (lower A)

Range: SPB or SYNC

This On-key function relates to the **Delay/Speed** switch [23] in the **LFO** section. When **Delay/Speed** is set to Speed, it is possible to extend its function by using the **Speed/Sync** On-Key function. Setting **Speed/Sync LFO 1** to **Speed** allows the speed of LFO 1 to be controlled by the rotary control [25]. Setting it to **Sync** reassigns the function of this

control, and allows the speed of LFO 1 to be synchronised to an internal or external MIDI clock, based on a sync value selected by the control [25]. Sync values are shown on the LED display. See Sync Values table on page 19.



LFO: Speed/Sync LFO 2 (lower A#)

Range: SPB or SYNC

This On-key function operates in a similar manner to **LFO: Speed/Sync LFO 1** above.



LFO: Slew LFO 1 (lower B)

Range: 0 to 127

Slew has the effect of modifying the shape of the LFO 1 waveform. Sharp edges become less sharp as the value of Slew is increased.



LFO: Slew LFO 2 (middle C)

Range: 0 to 127

This On-key function operates in a similar manner to **Slew LFO 1** above, but varies the slew for LFO 2.



Oscillator: Pitch Bend Range (upper C#)

Range: -24 to +24

The **Pitch Bend Range** parameter determines the maximum range (in semitones) that a note can be raised or lowered using the Pitch wheel [2]. A maximum of two octaves can be selected. A positive value increases the pitch of a note when the Pitch wheel is rotated "forwards" and decrease its pitch when it is rotated "backwards". A negative Pitch Bend value reverses this relationship.



Oscillator: Osc 1-2 sync (upper D)

Range: OFF or ON

Osc 1-2 sync is a technique of using Osc 1 to add harmonics to Osc 2 by using oscillator 1's waveform to re-trigger that of oscillator 2. When **OSC 1-2 sync** is On, the Sync 1-2 LED [20] is illuminated. See page 9 for further details.



Velocity: Amp Env (upper D#)

Range: -63 to +63

This function adds touch sensitivity to overall volume, so that with positive parameter values, the harder you play the keys, the louder will be the sound. With **Amplitude Velocity** set to zero, the volume is the same regardless of how the keys are played. The relationship between the velocity at which a note is played and volume is determined by the value. Note that negative values have the inverse effect.



For the most "natural" playing style, try setting **Amp Env** to about +40.



Velocity: Mod Env (upper E)

Range: -63 to +63

As **Amp Env** adds touch sensitivity to volume, so **Mod Env** can be set to make the effect of anything being controlled by the Modulation envelope become touch sensitive. With positive parameter values, the harder you play the keys, the greater will be the effect of the modulation. Note that negative values have the inverse effect.



VCA: Limiter (upper F)

Range: 0 to 127

Because Bass Station II can generate a very wide dynamic range – particularly if the filter section is adjusted close to self-oscillation – it may be desirable to apply limiting to the synth output to control the signal level. This On-key function applies a simple limiter (there are no other controls) to the VCA stage. It is best adjusted after all other sound parameters have been tweaked; if possible, set it while checking the output level on the meter of a mixer or amplifier to ensure that no clipping occurs while any in-performance controls are adjusted. As the parameter value is increased, the limiting becomes more severe, resulting in a compressed sound at lower output level. You may have to turn the volume up externally to compensate for limiting.

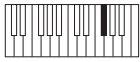
**Arp: Swing** (upper F#)

Range: 1% to 99%

This modifies the rhythm of the current arp pattern. See page 17 for a full description.

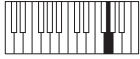
**Arp: Seq Retrig** (upper G)

Range: 0FF or 0H

This forces a repeat of the current sequencer pattern regardless of the length of the arp pattern. See page 17 for a full description.

**Global: MIDI Channel** (upper G#)

Range: 1 to 16

This On-key function lets you select the MIDI channel to be used for transmitting and receiving MIDI data to/from other equipment (such as the MIDI sequencer within your DAW). Hold the **Function/Exit** button **5** down and press the upper G note. The display will flash, showing the current MIDI channel number (1 if it has not been changed from the factory default). Release **Function/Exit**. You can now use the Patch/Value keys to alter the channel number. The new channel number will be stored and reinstated after a power-down.

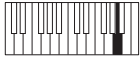
**Global: Local** (upper A)

Range: 0H or 0FF

This control determines whether Bass Station II is to be played from its own keyboard, or to respond to MIDI control from an external device, such as a MIDI sequencer or master keyboard. Set **Local** to **On** to use the keyboard, and to **Off** if you are going to control the synth externally via MIDI or use Bass Station II's keyboard other external MIDI devices.

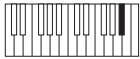
**Global: Tune** (upper A#)

Range: -50 cents to +50 cents

This parameter lets you make finer adjustments to the overall synth tuning. The increments are cents (1/100 of a semitone), and thus setting the value to ±50 tunes the oscillator to a quarter-tone midway between two semitones.

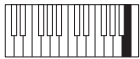
**Global: Input Gain** (upper B)

Range: -10 dB to +50 dB

This adjusts the gain of the external audio input applied at the rear panel **EXT IN** connector (6). The default value is zero (unity gain)

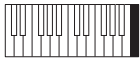
**Global: Dump** (upper C)

Range: n/a

Use this On-key function to transmit current synth parameters via MIDI as a SysEx message. This allows you to store personal Patches on your computer for back-up purposes. The data is transmitted from both the USB port and MIDI OUT sockets on the rear panel. You can either transmit just the current Patch, or all 128. Hold the **Function/Exit** button and hit the key. The display will show 0nE. Keeping the **Function/Exit** button pressed, hit the key again, and all current synth parameters will be transmitted. Alternatively, press the **Patch/Value** buttons, the display will show All. Keeping the **Function/Exit** button pressed, hit the key again; Bass Station II will now transmit the parameters of all 128 Patches in sequence, so that you will have a backup of your entire synth.

APPENDIX

Importing Patches via SysEx

The On-Key Dump function lets you save any or all of your Bass Station II Patches to a computer by transmitting the data in the form of MIDI SysEx messages. This would not be very useful without a method of loading Patches into the synth from the computer!

In addition to loading Patches which you may have saved, you may also want to load new Patches which you have downloaded from the Novation website. (Remember to check the website from time to time, as our sound programming team is constantly coming up with great new sounds for you to use.)

Use whatever MIDI software you have installed on your computer to upload Patches as SysEx data. You will need to know where the Patch files are saved on your hard drive, of course.

When you send a single Patch from your computer, Bass Station II loads it into a buffer memory, but it becomes the currently active Patch – i.e., you can use it straightaway. However, if you change to another Patch on the synth, the uploaded Patch will be lost. If you want to upload a Patch into your synth and save it for future use, you must Save it in the normal manner (see “Saving Patches” on page 7). As with saving any modified Patch, if you just press Save, the Patch in the currently-selected location will be overwritten. If you want to Save the uploaded Patch in a specific memory location (Patch number), you must first scroll to that location before Saving.

If you send a complete patch library, you will automatically overwrite every Patch in the synth. This is useful – as it allows you to restore the synth to its original factory Patch settings – but note that it will overwrite all existing Patches, so if you have not backed them up they will be lost. Use with caution!

Sync values table

This table explains what the display will show when altering the Speed/Sync setting for either of the LFOs (by turning the LFO rotary controls [25] when On-Key function **LFO: Speed/Sync LFO 1** is set to Sync).

	Display	Display Meaning	Musical Description	MIDI Ticks
1	64	64 beats	1 cycle per 16 bars	1536
2	48	48 beats	1 cycle per 12 bars	1152
3	42	42 beats	2 cycles per 21 bars	1002
4	36	36 beats	1 cycle per 9 bars	864
5	32	32 beats	1 cycle per 8 bars	768
6	30	30 beats	2 cycles per 15 bars	720
7	28	28 beats	1 cycle per 7 bars	672
8	24	24 beats	1 cycle per 6 bars	576
9	21 + 2/3	21 + 2/3	3 cycles per 16 bars	512
10	20	20 beats	1 cycle per 5 bars	480
11	18 + 2/3	18 + 2/3	3 cycles per 14 bars	448
12	18	18 beats	1 cycle per 18 beats (2 cycles per 9 bars)	432
13	16	16 beats	1 cycle per 4 bars	384
14	13 + 1/3	13 + 1/3	3 cycles per 4 bars	320
15	12	12 beats	1 cycle per 12 beats (1 cycle per 3 bars)	288
16	10 + 2/3	10 + 2/3	3 cycles per 8 bars	256
17	8	8 beats	1 cycle per 2 bars	192
18	6	6 beats	1 cycle per 6 beats (2 cycles per 3 bars)	144
19	5 + 1/3	5 + 1/3	3 cycles per 4 bars	128
20	4	4 beats	1 cycle per 1 bar	96
21	3	3 beats	1 cycle per 3 beats (4 cycles per 3 bars)	72
22	2 + 2/3	2 + 2/3	3 cycles per 2 bars	64
23	2nd	2nd	2 cycles per 1 bar	48
24	4th dotted	4th dotted	2 cycles per 3 beats (8 cycles per 3 bars)	36
25	1 + 1/3	1 + 1/3	3 cycles per 1 bar	32
26	4th	4th	4 cycles per 1 bar	24
27	8th dotted	8th dotted	4 cycles per 3 beats (16 cycles per 3 bars)	18
28	4th triplet	4th triplet	6 cycles per 1 bar	16
29	8th	8th	8 cycles per 1 bar	12
30	16th dotted	16th dotted	8 cycles per 3 beats (32 cycles per 3 bars)	9
31	8th triplet	8th triplet	12 cycles per 1 bar	8
32	16th	16th	16 cycles per 1 bar	6
33	16th triplet	16th triplet	24 cycles per 1 bar	4
34	32nd	32nd	32 cycles per 1 bar	3
35	32nd triplet	32nd triplet	48 cycles per 1 bar	2

Init Patch – parameter table

This list gives the values of all synth parameters in the Init Patch (the factory Patch initially loaded into Patch memories 64 to 127):

Section	Parameter	Initial Value
Master	patch volume	100
Oscillator	Osc 1 fine	0 (centre)
	Osc 1 range	8' (A3=440Hz)
	Osc 1 coarse	0 (centre)
	Osc 1 waveform	saw
	Osc 1 Mod Env depth	0 (centre)
	Osc 1 LFO 1 depth	0 (centre)
	Osc 1 Mod Env PW mod amount	0 (centre)
	Osc 1 LFO 2 PW mod amount	0 (centre)
	Osc 1 manual PW amount	50. (centre)
	Osc 2 fine	0 (centre)
	Osc 2 range	8' (A3=440Hz)
	Osc 2 coarse	0 (centre)
	Osc 2 waveform	saw
	Osc 2 Mod Env depth	0 (centre)
	Osc 2 LFO 1 depth	0 (centre)
	Osc 2 env 2 PW mod amount	0 (centre)
	Osc 2 LFO 2 PW mod amount	0 (centre)
	Osc 2 manual PW amount	50. (centre)
	Sub Osc oct	-1
	Sub Osc wave	sine
Mixer	Osc 1 level	255 (right)
	Osc 2 level	0 (left)
	Sub Osc level	0 (left)
	Select noise, ring, ext	0 (left)
	Noise level	0 (left)
	Ring mod level	0 (left)
	External signal level	0 (left)
Filter	Type	Classic
	Slope	24dB
	Shape	LP
	Frequency	255 (right)
	Resonance	0 (left)
	Mod Env depth	0 (centre)
	LFO 2 depth	0 (centre)
	Overdrive	0 (centre)
Portamento	Portamento time	0 (left)
LFOs	LFO 1 speed	75 (7.9Hz)
	LFO 1 delay	0 (left)
	LFO 2 speed	52 (3Hz)
	LFO 2 delay	0 (left)
	LFO 1 wave	tri
	LFO 2 wave	tri
	LFO 1 Sync value	off
	LFO 2 Sync value	on
Envelope	Amp env attack	0 (bottom)
	Amp env decay	0 (bottom)
	Amp env sustain	127 (up)
	Amp env release	0 (bottom)
	Amp env triggering	Multi
	Mod Env attack	0 (bottom)
	Mod Env decay	0 (bottom)
	Mod Env sustain	127 (right)
	Mod Env release	0 (bottom)
	Mod Env triggering	Multi
	Amp and Mod Env triggering	Multi
Effects	Distortion	0 (left)

	Osc Filter Mod	0 (left)
Arpeggiator	On	off
	Latch	off
	Rhythm	32
	Note mode	up
	Octaves	1
Octave Area	Key transpose	0
	Octave	0
Other	Mod	0
On Key Functions		
Mod Wh	LFO 2 Filter Freq	0
	LFO 1 Osc Pitch	10
	Osc 2 Pitch	0
Aftertouch	Filter Freq	10
	LFO 1 to Osc Pitch	0
	LFO 2 Speed	0
LFO	Key Sync LFO 1	off
	Key Sync LFO 2	on
	Speed/Sync LFO 1	speed
	Speed/Sync LFO 2	speed
	Slew LFO 1	0
	Slew LFO 2	0
Oscillator	Bend Amount	12 (oct up and down)
	Osc 1-2 Sync	off
Velocity	Amp Env	0
	Mod Env	0
VCA	Limit	0
Arp	Arp Swing	50
	Seq Retrig	on
Global	MIDI Chan	1
	Local	on
	Tune	0
	Input Gain	0

Synth settings saved on power-off

1	Input Gain
2	Master Tune
3	MIDI Channel

Synth settings not saved on power-off

1	Local setting is not retained. Default to ON
2	Editable patch memory (if not Saved to a preset location)
3	Current patch number. Defaults to patch zero

MIDI parameters list

Section	Parameter	CC / NRPN	Control No.	Range
Master				
	patch volume	cc	7	0 to 127
	patch inc	prog change		0 to 127
	patch dec	prog change		0 to 127
Oscillator				
	osc 1 fine	cc	26:58	-100 to 100* (to 1 dec place, no 0 for ints)
	osc 1 range	cc	70	16',8',4',2' (MIDI val of 63, 64, 65, 66)
	osc 1 coarse	cc	27:59	-12. to 12.
	osc 1 waveform	NRPN	0:72	sine, tri, saw, pulse
	osc 1 Mod Env depth	cc	71	-63 to +63*
	osc 1 LFO 1 depth	cc	28:60	-127 to 127*
	osc 1 Mod Env PW mod amount	cc	72	-63 to 63*
	osc 1 LFO 2 PW mod amount	cc	73	-90 to 90 (MIDI val of 63 & 64 = 0%)
	osc 1 manual PW amount	cc	74	5. to 95. (MIDI val of 64 = 50%)
	osc 2 fine	cc	29:61	-100 to 100* (to 1 dec place, no 0 for ints)
	osc 2 range	cc	75	16',8',4',2' (MIDI val of 63, 64, 65, 66)
	osc 2 coarse	cc	30:62	-12. to 12* (to 1 dec place, no 0 for ints)
	osc 2 waveform	NRPN	0:82	sine, tri, saw, pulse
	osc 2 Mod Env depth	cc	76	-63 to +63*
	osc 2 LFO 1 depth	cc	31:63	-127 to 127*
	osc 2 env 2 PW mod amount	cc	77	-63 to +63*
	osc 2 LFO 2 PW mod amount	cc	78	-90 to 90 (MIDI val of 63 & 64 = 0%)
	osc 2 manual PW amount	cc	79	5. to 94.3 (MIDI val of 64 = 50%)
	sub osc oct	cc	81	-2,-1 oct below OSC 1
	sub osc wave	cc	80	sine, pulse, square
Mixer				
	osc 1 level	cc	20:52	0 to 255
	osc 2 level	cc	21:53	0 to 255
	sub osc level	cc	22:54	0 to 255
	noise level	cc	23:55	0 to 255
	ring mod level	cc	24:56	0 to 255
	external signal level	cc	25:57	0 to 255
Filter				
	Type	cc	83	Classic, acid
	slope	cc	106	12, 24
	shape	cc	84	LP, BP, HP
	frequency	cc	16:48	0 to 255
	resonance	cc	82	0 to 127
	Mod Env depth	cc	85	-63 to +63*
	lfo 2 depth	cc	17:49	-127 to 127*
	overdrive	cc	114	0-127
Portamento				
	portamento time	cc	5	off, 1 to 127

LFOs				
	LFO 1 speed	cc	18:50	0 to 255
	LFO 1 delay	cc	86	off, 1 to 127
	LFO 2 speed	cc	19:51	0 to 255
	LFO 2 delay	cc	87	off, 1 to 127
	LFO 1 wave	cc	88	
	LFO 2 wave	cc	89	
	LFO 1 Sync value	NRPN	87	
	LFO 2 Sync value	NRPN	91	
Envelope				
	amp env attack	cc	90	0 to 127
	amp env decay	cc	91	0 to 127
	amp env sustain	cc	92	0 to 127
	amp env release	cc	93	0 to 127
	amp env triggering	NRPN	0:73	1,2,3
	Mod Env attack	cc	102	0 to 127
	Mod Env decay	cc	103	0 to 127
	Mod Env sustain	cc	104	0 to 127
	Mod Env release	cc	105	0 to 127
	Mod Env triggering	NRPN	0:105	1,2,3
Effects				
	Distortion	cc	94	0 to 127
	Osc Filter Mod	cc	115	off, 1 to 127
Arpeggiator				
	on	cc	108	
	latch	cc	109	
	rhythm	cc	119	
	note mode	cc	118	
	octaves	cc	111	
Other				
	pitch	pitchbend		-8192 to 8191
	mod	cc	0	0 to 127
	sustain	cc	64	0 to 127
	after touch	aftertouch		0 to 127
Mod Wh				
	LFO 2 Filter Freq	NRPN	0:71	
	LFO 1 Osc Pitch	NRPN	0:70	-63 to +63
	Osc 2 Pitch	NRPN	0:78	-63 to +63
Aftertouch				
	Filter Freq	NRPN	0:74	-63 to +63
	LFO 1 to Osc Pitch	NRPN	0:75	-63 to +63
	LFO 2 Speed	NRPN	0:76	off, 1 to 127
LFO				
	Key Sync LFO 1	NRPN	0:89	OFF or On
	Key Sync LFO 2	NRPN	0:93	OFF or On
	Speed/Sync LFO 1	NRPN	0:87	
	Speed/Sync LFO 2	NRPN	0:91	
	Slew LFO 1	NRPN	0:86	
	Slew LFO 2	NRPN	0:90	
Oscillator				
	Bend Amount	cc	107	1 to 12
	Osc 1-2 Sync	cc	110	OFF or On
Velocity				
	Amp Env	cc	112	
	Mod Env	cc	113	
VCA				
	Limit	cc	95	0-127
Arp				
	Arp Swing	cc	116	
	Seq Retrigger	NRPN	106	

