



CORE[®]

REFERENCE CHANNEL STRIP



OWNER'S MANUAL

CHAPTER		PAGE
i)	Introduction	2
ii)	Manual Conventions	2
iii)	Copyright Notice	2
1.	Important Safety Instructions	3
2.	Getting Started	3
3.	Front Panel	4
4.	Input Section	4
5.	Optical Compressor	5
6.	Equalizer	5
7.	Limiter	6
8.	VU Meter	6
9.	Rear Panel	7-8
10.	Rear Panel Connections	9
11.	Operational Notes	9
12.	Questions	10
13.	Reading a VU Meter	10
14.	Servicing	11
15.	Core Calibration Procedure	11-12
16.	Curves & Specifications	13
17.	Recall Sheet	14

i) An Introduction To The Manley CORE® Reference Channel Strip

Thank you for selecting the Manley CORE® Reference Channel Strip. This unit combines a high quality vacuum tube microphone preamplifier, an ELOP® Compressor, an EQ section and a fast FET Brickwall Limiter.

Musical. Flexible. Forgiving.

These three concepts were our main goals in designing the CORE® channel strip. To give the musician tools he or she really needs, without needless complication.

Why is this important?

Because recording has become more complicated than ever!

Computers, plug-ins, and software can easily distract from creating your music. By designing a dedicated recording channel with very high quality stages – but without extra functions you will rarely use – you can concentrate on your art, not worry about the technology.

The elements that make up the CORE® are the result of decades of design, listening and experience of working with engineers and musicians. The CORE® may have fewer knobs than other units, but we think they are the right knobs!

ii) Manual Conventions

Please take a few moments to read through this manual carefully. It contains essential information for the proper operation of your Manley CORE Reference Channel Strip.

Also in the following pages you will find useful hints and tips, allowing us to help you achieve the utmost performance from your equipment.

Below are the following conventions, used to pick out particularly important parts of the manual. The symbols are found in the margin next to the body of text of interest.



Especially Useful Tip



Important Information. Read Carefully



Caution! Pay Attention!



Refer to another section in this Manual

iii) Notice

This manual provides general and technical information for use, installation, and operating instructions for the Manley CORE® Reference Channel Strip. Manley Laboratories, Inc. reserves the right to make changes in specifications and other information contained in this publication without prior notice. Manley Laboratories, Inc. shall not be liable for errors contained herein or direct, indirect, incidental or consequential damages in connection with the furnishing, performance, or use of this material. No statement contained in this publication, including statements regarding suitability or performance of products shall be considered a warranty by Manley Laboratories, Inc. for any purpose or give rise to any liability of Manley Laboratories, Inc.

© 2014 COPYRIGHT Manley Laboratories, Inc. All rights reserved.

This manual and any associated artwork, product designs, and design concepts are subject to copyright protection. No part of this document may be produced, in any form, without prior written permission of Manley Laboratories, Inc. CORE®, ELOP®, VOXBOX®, MANLEY® and the Manley Laboratories, Inc. logo are trademarks of Manley Laboratories, Inc.

1. Important Safety Instructions

1. **Water and Moisture** - Do not use The CORE near any source of water or in excessively moist environments.
2. **Object and Liquid Entry** - Care should be taken so that objects do not fall, and liquids are not spilled, into the enclosure through the openings.
3. **Heat & Ventilation** - When installing The CORE in a rack or any other location, be sure there is adequate ventilation. Improper ventilation will cause overheating, and can damage the unit. The unit should be situated away from heat sources, or other equipment that produce heat.
4. **Power Sources** - The CORE has a universal power supply which can operate in any country. It has an input voltage range of 90-260 VAC at 50/60 Hz.
5. **Cleaning** - The CORE can be cleaned with just a damp cloth, or alcohol/methylated spirits for more stubborn marks.
6. **Damage** - If after unpacking your CORE there are signs of shipping damage, contact your dealer.
7. **Servicing** - Do not attempt any servicing without consulting your dealer or Manley Laboratories, Inc. The user should not attempt to service the unit beyond that described in the operating instructions. All other servicing should be referred to qualified service personnel. This unit has **high voltages** present, even after the power has been switched off.
8. **DO NOT** connect the AC supply cord until all other connections have been made. After initial power up the VU Meter back light will “blink” for thirty seconds. The unit remains in MUTE until this warm up period has elapsed.

2. Getting Started

Unpacking your CORE:

The CORE is secured in its packing carton by two end-caps.

Hold the unit by the middle and simply lift the unit vertically straight out of the box.

After it has been unpacked, check that nothing is loose inside when handling the unit. The unit is shipped with the vacuum tubes installed. Make sure they are not loose by looking through the vent holes on the top cover. Ensure they are standing upright in their sockets.

It is advisable to keep the original packaging. In the event of servicing or relocating, the original packaging ensures that the unit will always be shipped safely.

This package contains the following;

- 1 x Manley CORE Reference Channel Strip
- 1 x Manley CORE Owner's Manual
- 1 x IEC Power Cable
- 1 x Warranty Registration Card
- 1 x Warranty Statement



3. Front Panel

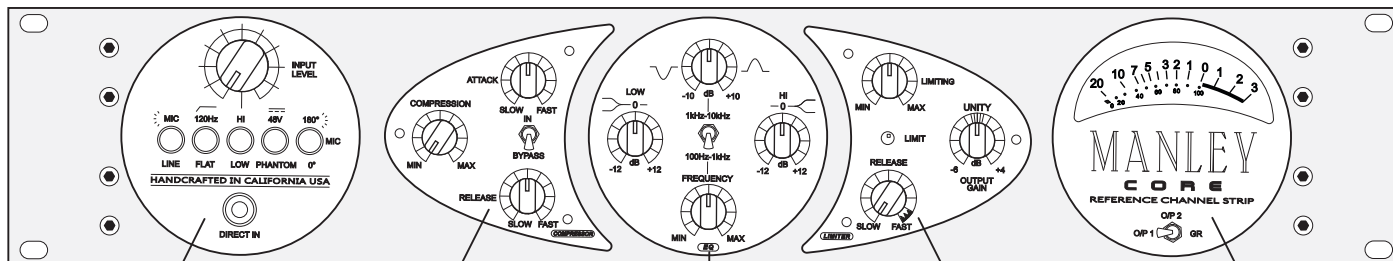

PREAMPLIFIER

- Input Attenuator
- Mic/Line Source Select
- High Pass Filter
- High/Low Gain
- Mic 48V Phantom
- Mic Phase Invert
- Instrument Direct Input

COMPRESSOR

- Attack
- Release
- Bypass
- Compression (Threshold)

EQ

- High & Low Shelf
- Sweepable Mid Frequency
- Low/High Range Select
- Continuously Variable Frequency Selection

LIMITER

- Fast Attack FET Brickwall Limiter
- Limiting/Threshold
- Release
- Limit LED Indicator
- Output Gain Control

VU METER

- Meter Source Select Switch
- Displays Audio;
- Compressor Gain Reduction
- Tube Preamp Out
- Final Output

As the signal flow in the CORE is from right to left, we'll describe the functions in that order as well:

4. Input Section

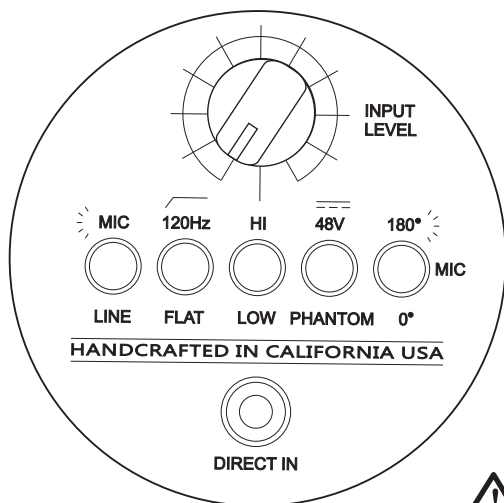

Diagram 2

The INPUT LEVEL control is an input attenuator. It functions like a variable pad. It acts on the Direct In (DI), Mic and Line inputs. Fully counter-clockwise is off, and clockwise rotation increases the level. For the Mic input, fully clockwise represents about 40dB of gain.

With the gain switch set to LOW and the input level set fully clockwise the MIC input will yield about 40dB of gain and the LINE input will produce 20dB of gain.

The top label of the selector switches show operational status when the button is pushed in and illuminated.

MIC/LINE selects either the MIC XLR input or it selects the LINE XLR or DI 1/4 " inputs.

The 120Hz high pass filter position is useful for reducing breath "pops," or any time a reduction of LOW frequencies such as train or traffic rumble or air conditioning rumble.

The HI/LOW gain switch adds 10dB of gain (or when the internal jumper is set, 20dB of gain) to the circuit when engaged. For most applications, this switch can be in the LOW position, but for low output microphones or quiet sources, extra gain may be needed. (Note: If the internal 20dB jumper is used, noise floor will also increase.)



48 Volt "PHANTOM" power is applied to the Mic input XLR when this switch is engaged. This should only be used for microphones that require phantom power.

0° / 180° - The Mic phase switch inverts the signal by 180 degrees when engaged.

DIRECT IN, Instrument input. This 1/4 inch input jack is for use with guitars, keyboards, or any other instrument. When a plug is inserted the CORE will automatically switch to the DI input. The Mic/Line switch must be set to the Line position to activate the DI. This is an unbalanced 10 MegOhm input that will not load down Hi Z instruments such as a guitar. The connections on this TS Jack are TIP-HOT, SLEEVE-GROUND.

5. ELOP® Compressor

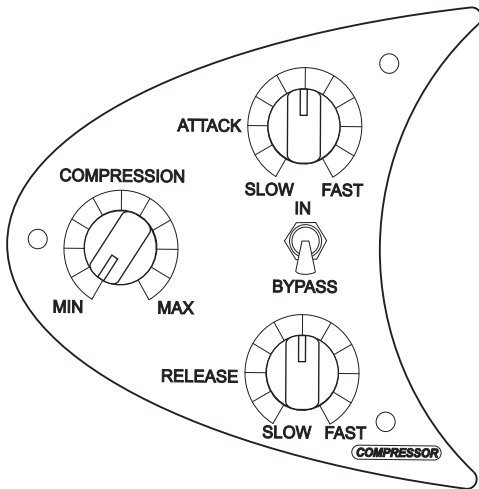

Diagram 3

The ELOP® Compressor utilizes our famous circuit topology as found in the VOXBOX®, and is also similar to the ELOP® and SLAM limiters.

The COMPRESSION (Threshold) control determines at what level the compressor begins to act. Clockwise rotation makes the compressor reduce the signal.

With the meter in the “GR” position, the amount of gain reduction can be displayed. (Refer to Diagram 6, pg.6)

The ATTACK control determines how long the compressor takes to respond to signals above the threshold.

The RELEASE control determines how long the compressor takes to recover after the signal falls below the threshold level.

The BYPASS switch can be used to bypass the compressor section. It may be used during recording as the switching process is silent.

The output after this stage is available on XLR O/P 1 and also at the INSERT SEND. (Refer to Diagram 7, pg.8) This audio level can be monitored on the VU Meter.

While compression is one of the most powerful tools in recording, it is possible to overdo it. And, unlike EQ, it's not reversible. Although there are really no rules when it comes to creativity and the recording process, a few guidelines can be helpful. When it comes to vocals, you might not need more than a couple dB of gain-reduction. It's better to adjust the singing style or distance from the mic than to rely on compression to get a totally even performance. That said, there is no harm in really burying the GR needle if that's the sound you're going for.

Try starting with the attack and release knobs in the 12 O'clock position and go for a dB or three of gain reduction. If there are still peaks that are sounding too loud, move the attack more clockwise to the faster settings. For percussive sounds, starting with a faster attack can also be good. Putting the attack and release fully clockwise and really getting a lot of gain reduction can also produce an interesting sound. Consider combining a track processed this way with one done at minimal compression.

6. Equalizer

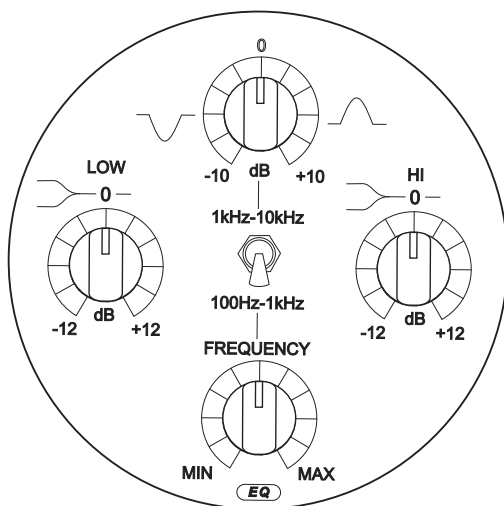

Diagram 4

The LOW and HI Shelf controls are Baxandall curves centered around 90 Hz and 12kHz respectively. At 12 O'clock no equalization is occurring. Fully CCW will reduce levels below the center frequency to a maximum of 12dB. Fully CW will increase levels above the center frequency to a maximum of 12dB.

The Mid Frequency EQ is a bell shaped curve, with a range control in the low position of 100Hz to 1kHz, and in the high position, between 1kHz and 10kHz. The desired range is selected using the toggle switch. One can then boost or cut at the selected frequency by approximately 10dB.

The FREQUENCY control allows continuous sweepable frequency of the selected range so that you can TUNE IN the desired frequency.

The controls that run vertically through the middle of the EQ section are: MID FREQUENCY EQ, TOGGLE RANGE SWITCH, and FREQUENCY SWEEP. These all operate together. There is substantial overlap available between the shelf and peaking controls, allowing a large amount of EQ control.

The EQ response curves can be seen on page 13.

7. Limiter

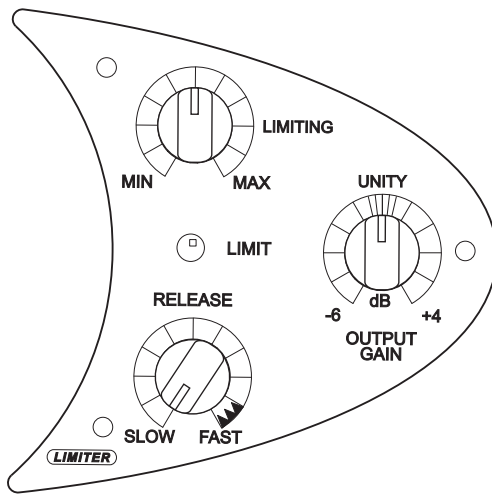

Diagram 5

The FET output limiter is a powerful, high-ratio, peak limiter. It can be used for many creative effects, as well as for setting a maximum output ceiling to avoid overloading the next piece of gear in the chain.

The LIMITING knob controls the amount of limiting. The LIMIT LED lights when the signal crosses the threshold, and goes off when the signal is both below the threshold and the release time is completed.

The RELEASE controls how FAST or SLOW the limiter returns to full volume. The

RELEASE time control has purposely been made with a very wide control range. Very fast release times can create a distortion effect, this area of the RELEASE control is highlighted with a zig-zag on the dial.

The Final OUTPUT GAIN control has a range of 10dB. This is an active gain stage following the FET limiter that can both attenuate and amplify the Main Output. This output is available from XLR O/P 2. (Refer to Diagram 7, pg.7) The UNITY gain position will be within the hash marks around the 12 o'clock area. Due to component tolerances there may be slight variations from unit to unit.



When Limiting is set to “Minimum” the LIMIT light acts as a general overload indicator at +20 dBu.

8. VU Meter

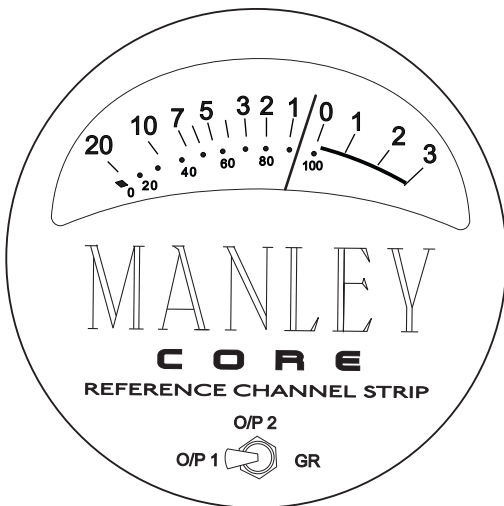

Diagram 6

Three positions are selectable on the analog VU meter selector switch.

O/P 1- shows the audio level of the DIRECT OUTPUT of the preamplifier and compressor section.

O/P 2 - shows the MAIN OUTPUT audio level of the CORE.

GR - indicates the amount of COMPRESSOR gain reduction in decibels. This position stays at “0 VU” when there is no gain reduction and moves to the left to show the amount of compression.

Because the VU meter is mechanical and really just shows the average level, it can't follow every signal exactly. In fact, things like snare drums are not displayed very accurately at all. The VU meter might only be ticking over at -10, but the actual peak level may be 20dB higher. This is OK, as every workstation has a digital peak meter. And it's a good idea to keep all of your peak levels in the DAW to around -6dBFS anyway. There is no reason to go to 0dBFS on the individual tracks, and the final result will sound better and actually combine better if the tracks are recorded with some headroom below zero.

Also, it's a good general practice to look at the VU meter occasionally when recording and try to keep the majority of the track on the scale of the meter - not a hard and fast rule - but if you are pinning it all the time (unless for an intentional effect) or the needle isn't moving at all, you might need to adjust the input gain of the CORE.

9. Rear Panel

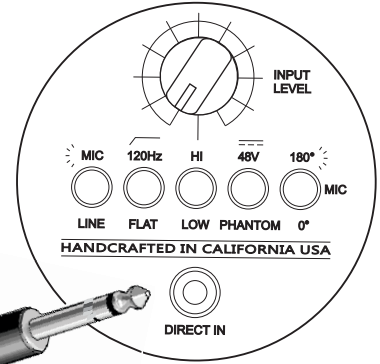
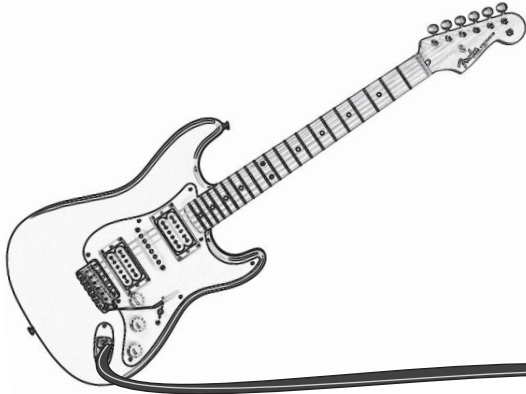

DIRECT INP

! MAINS VOLTAGE SHOWN ON SERIAL TAG WARNING: TO REDUCE THE RISK OF FIRE OR ELECTRIC SHOCK, DO NOT EXPOSE THIS UNIT TO RAIN OR MOISTURE. CAUTION: RISK OF ELECTRIC SHOCK. DO NOT OPEN. REFER SERVICING TO QUALIFIED PERSONNEL ONLY. ⚡

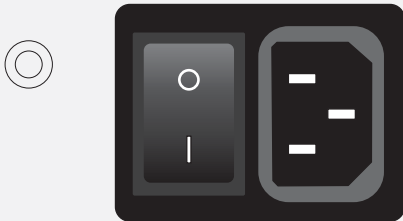

SERIAL NUMBER

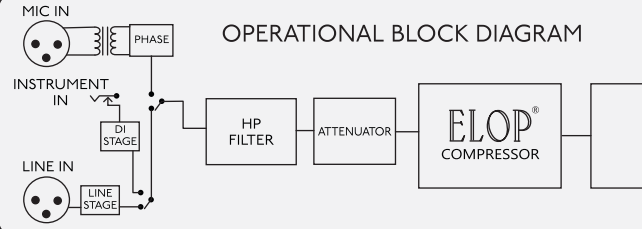

OPERATIONAL BLOCK DIAGRAM

MANLEY LABORATORIES INC.
13880 MAGNOLIA AVE. CHINO, CA 91710
PHONE +1 (909) 627-4256
SERVICE@MANLEYLABS.COM
WWW.MANLEY.COM



HANDCRAFTED IN USA

MAIN OUTPUT (2)

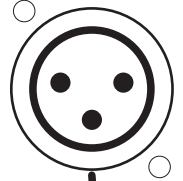

OPTIONAL OUTBOARD
ANALOG TO DIGITAL CONVERTER

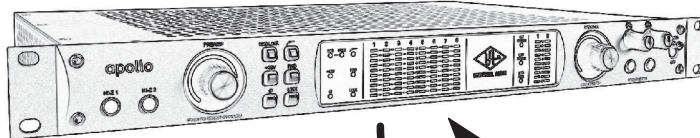

SIGNAL PR
EQ OR CO

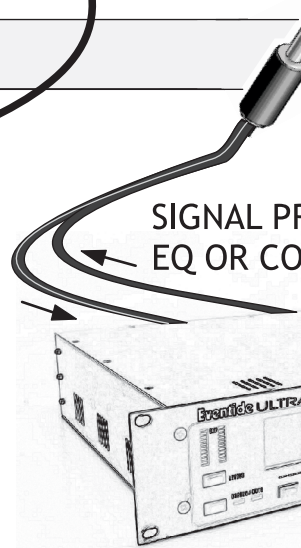

INPUT (FRONT PANEL)

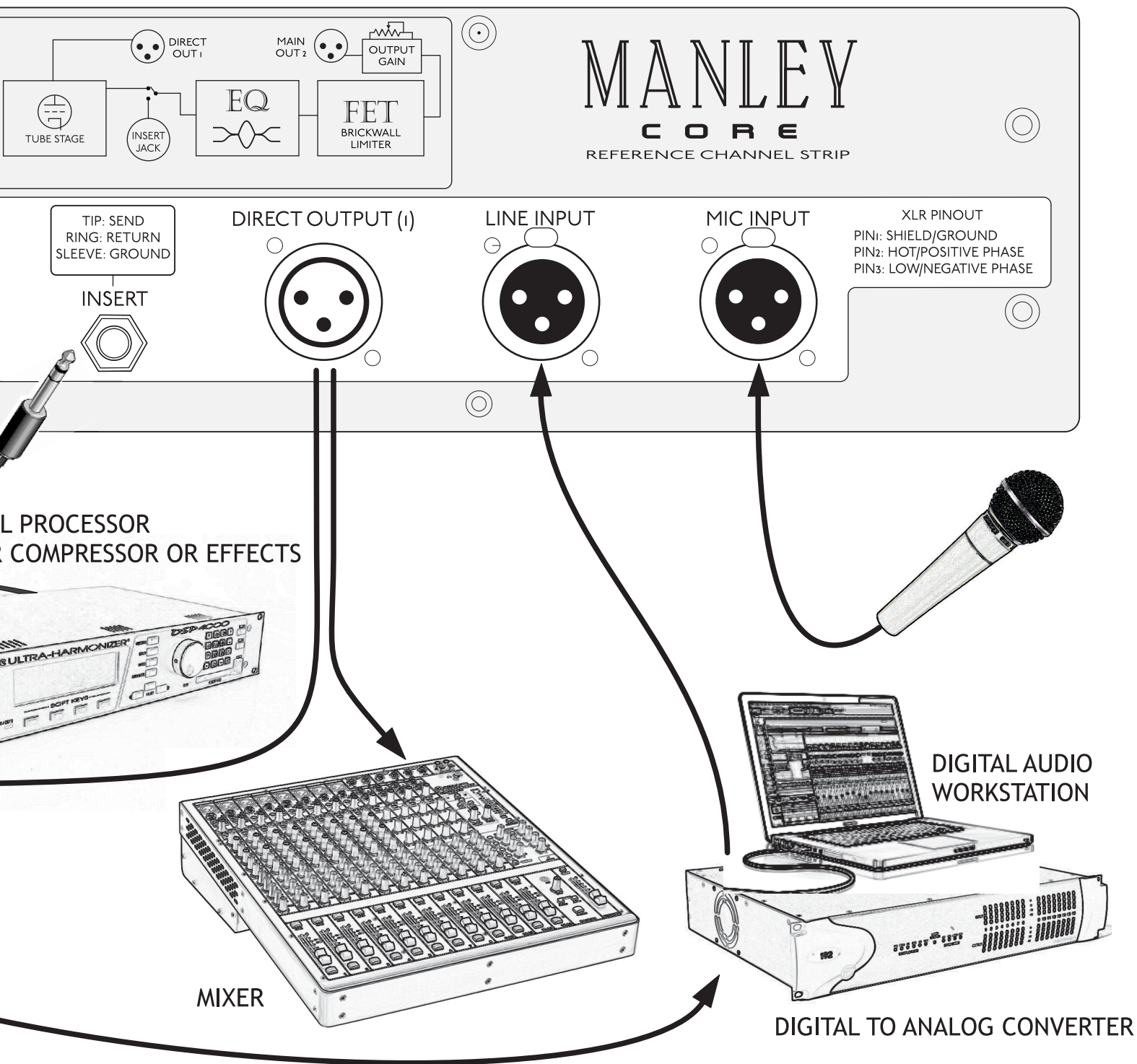

10. Rear Panel Connections

From Right to Left:

MIC INPUT: This is a transformer balanced, microphone input to the preamplifier. The pinout is PIN 1: Ground, PIN 2: HOT (+), PIN 3: COLD(-).

All pins must be driven. DO NOT “float” PIN 2 or PIN 3.

LINE INPUT: An electronically-balanced, line-level input.

The pinout is PIN 1: Ground, PIN 2: HOT (+), PIN 3: COLD(-). An unbalanced source can be connected with PIN2 or 3 grounded. Unused pins can be grounded.

DIRECT OUT (1): Gives an pseudo or impedance balanced output directly after the tube preamp and ELOP® compressor stage. The pinout is PIN 1:Ground, PIN 2: HOT (+), PIN 3: COLD(-). An unbalanced source can be connected with PIN3 grounded.

INSERT: This TRS 1/4” jack interrupts the connection between the PREAMP/COMPRESSOR and EQ/FET LIMITER sections, allowing external gear to be inserted into the signal path. Alternately, it provides an input to the CORE that is after the tube preamp, to the input of the EQ stage. The interface is unbalanced in and out. The pinout is TIP: SEND, RING: RETURN, SLEEVE: GROUND.

OUTPUT (2): This is the main output from the CORE which is an electronically-balanced output. It is after the EQ/Limiter section. The pinout is PIN 1: GROUND, PIN 2: HOT (+), PIN 3: COLD(-). An unbalanced source can be connected with PIN2 or 3 floated but DO NOT ground pin 2 or 3.

11. Operational Notes

Unbalanced Operation

All of the XLR inputs of the CORE can be used with either balanced or unbalanced sources. However, the Main (2) XLR output should only be connected to balanced inputs. If it's necessary to connect to a unbalanced input, a cable must be used that has NO connection on XLR pin 3. This is important in order to prevent damage to the CORE, as well as distortion to the signal. DO NOT GROUND PINS 2 OR 3 on the MAIN O/P 2.

Getting the most from your CORE

Earlier, in the Introduction we mentioned one of the three design principles was “Forgiving”. We want the CORE to be easy to use and difficult to make a bad sound! An example of this is the placement of the compressor before the amplifier stages. This allows the signal to be reduced by the compressor first which prevents the preamp from being overloaded. Setting the COMPRESSION level just at the start of gain-reduction will allow you to get the full dynamic range of the source, but if the musician suddenly plays louder the compressor will gracefully ride the level down.

Another forgiving element of the CORE is the FET output limiter which can be set to reduce just under the overload level of the following piece of gear. This can be especially useful to protect an A/D converter from overload.

There is no rule that says you can't put a line-level signal in the Mic input. Try it! Many different transformer or tube saturation effects can be made this way.

Just be careful not to engage the PHANTOM power 48V switch if you have anything other than a phantom-powered microphone plugged into the MIC INPUT.



12. Questions

Q: “Where’s the -20dB pad switch?”

Because the input attenuator precedes the tube gain stage, the input level control acts as a variable pad. It should be used to either reduce the level of a hot input signal, or to simply set the overall gain of the preamp. For best performance keep the GAIN switch set to LOW. HIGH gain should be used only if there is not enough gain with the INPUT LEVEL knob turned to maximum.

Q: “Sometimes I hear distortion in the peak limiter!”

To allow for maximum creativity, the release time of the limiter was intentionally allowed to operate over a wide range. This means that with some signals, when the release time is set to the fastest setting some audible distortion may be created. But not to worry, if this distortion is not desired, just turn the release time knob counter-clockwise and slow down the release time. The sound of a super-fast release time can be used as a creative effect. Try it on vocals or drums! Try it on anything. You won’t damage any circuitry!

Q: “I am having problems with troubleshooting ground loops?”

Try and resolve any grounding issues in your setup by using dedicated cabling etc. If you cannot remove a ground loop in your setup, you can disconnect the Signal Ground from the Chassis ground on the Core by removing the Ground Lift jumpers, as shown in diagram 9. They are labeled P100 & p101 on the circuit board.

Q: Why do I hear some hiss at the higher GAIN settings?

The input control is an ATTENUATOR, not a volume control. It is used to reduce the level of a hot signal, not boost the level of a weak one. The default position on this control is FULL CLOCKWISE. Turning this control up does not raise the noise level, but stepping up the gain DOES. The lowest noise performance is going to be with the INPUT control fully CW (Clockwise), and with the GAIN switch set at the lowest setting (40db). When set to the 60db gain setting, you might hear some hiss.

Go to www.manley.com and read our extensive FAQ for more information about the care and feeding of

13. Reading a VU Meter

Diagram 8

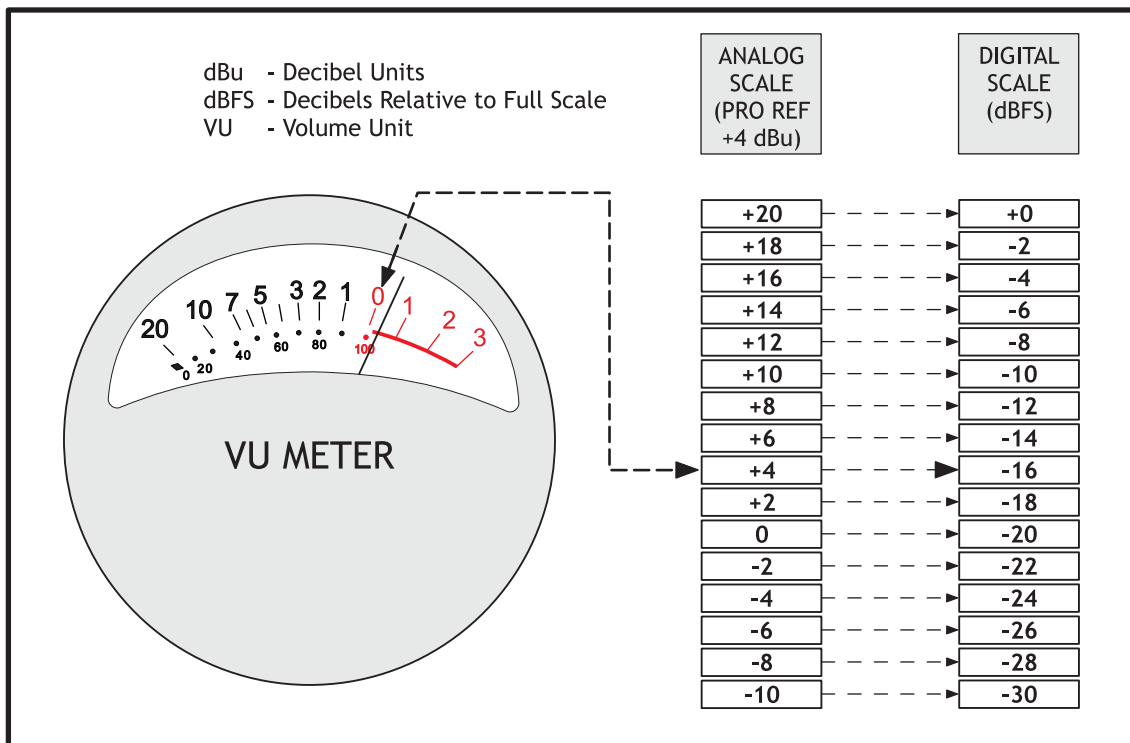

14. Servicing

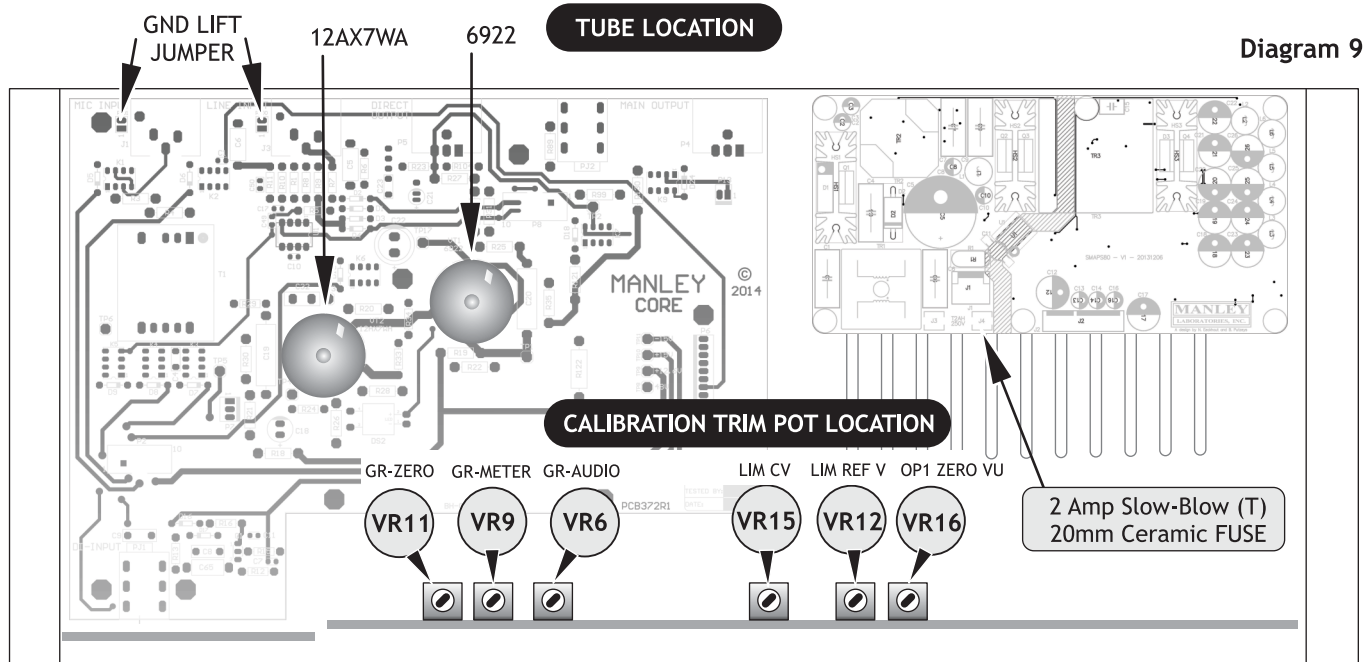
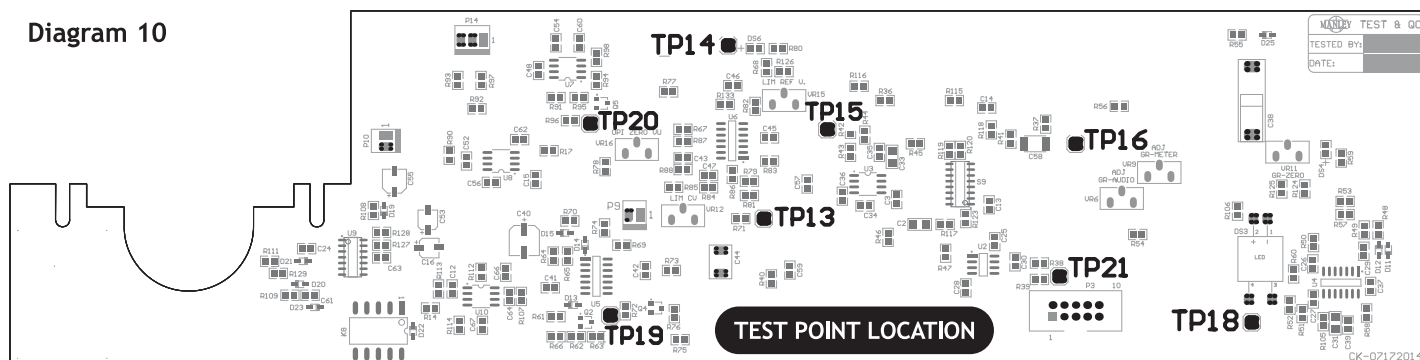

Diagram 10



15. Core Calibration Procedure

CALIBRATION / INTERNAL ADJUSTMENTS - FOR EXPERIENCED TECHNICIANS ONLY*

The CORE requires calibration for 3 sections of its circuitry:

- i) VU METER- Adjust: +4dBu (1.228 Volts RMS) = "0" VU, Meter "GR" zero set
- ii) ELOP® COMPRESSOR - Adjust: Gain Reduction (Audio & Meter GR)
- iii) FET PEAK LIMITER - Adjust: reference voltage & FET control voltage

Tools required:

- Audio Tone Generator (oscillator)
- Audio Analyzer or a voltmeter capable of reading both DC & AC voltages.

Initial settings:

- Mic/Line Input select switch: Out = LINE IN Enable
- 120Hz HP filter switch: Out = Disable
- Gain switch: Out = LOW
- 48V Phantom switch: Out = OFF
- Phase Invert switch: Out = 0
- Input Level Attenuator: Set at Minimum
- Compressor Section: Switch = Bypass; Compression = MAX, Attack & Release = FAST
- Shelving EQ section: High/Low controls set both = 12:00 o'clock.
- Mid EQ section: Boost/Cut control = 12:00 O'clock, Frequency range select switch = 100Hz-1kHz, Frequency sweep control = MIN
- Peak Limiter section: Limiting = MIN, Release = 12:00 o'clock
- Output Gain Control: 12:00 o'clock

*** Experienced Technicians Only**

The calibration procedures mentioned here are to aid the servicing of the unit. They should only be attempted by a skilled Technician. These adjustments should not be attempted by the user without experience. Trimming these potentiometers without the correct understanding will result in poor performance of the unit.

i) CALIBRATION OF VU METER:

- 1- Feed a balanced sine tone @ 1 KHz, +4dBu (1.228V RMS) from an audio tone generator/oscillator into the LINE INPUT XLR.
- 2- Use your audio analyzer and/or, set your voltmeter to read volts AC and put it at the output of XLR "OP1". Start bringing up the Input level attenuator until you have +4dBu (1.228V RMS) at the output XLR "OP1". This will be the same level as the input signal from oscillator (unity gain)
- 3- Use the VU meter select switch to read "OP1". Adjust **VR16** (OP1 ZERO VU) so that the meter reads "0" VU.
- 4- Use the VU meter select switch to read "GR". Adjust **VR11** (GR-ZERO) so meter reads "0" VU.

ii) CALIBRATION OF ELOP® COMPRESSOR:

- 1- Make sure the output level at XLR "OP1" is still set for +4dBu, and the meter reading for "OP1" is "0" VU.
- 2- Move your voltmeter (Volts AC)/Audio Analyzer to read the output XLR "OP2".
- 3- Use the VU meter select switch to read "OP2".
- 4- Adjust the OUTPUT GAIN control for an output level of +4dBu (1.228V RMS) at "OP2". Meter reading for "OP2" should be "0" VU.
- 5- Switch IN the COMPRESSOR.
- 6- Adjust **VR6** (GR-AUDIO) for a gain reduction of 6dB at "OP2". (The output XLR "OP2" will read -2 dBu).
- 7- Use the VU meter select switch to read "GR".
- 8- The VU meter should read -6. If not, adjust **VR9** (GR-METER). Verify that VU "GR" and audio are within 0.2dB of each other.
- 9- Repeat steps 6 to 8.
- 10- Switch out the COMPRESSOR by switching it to BYPASS.

iii) CALIBRATION OF PEAK LIMITER:

- 1- Make sure the output level at XLR "OP2" is still reading +4dBu, and the meter reading for "OP2" is "0" VU.
- 2- Turn OFF your audio generator/oscillator temporarily to complete next step.
- 3- Switch your voltmeter to read Volts DC. Locate test point **TP13** on the front panel PCB and use your voltmeter to check for a voltage reading of +9.0VDC (± 0.1 VDC). Adjust **VR15** (LIM REF V.) So that TP13 reads 9.0 VDC. Locate test point **TP14** verify a voltage reading of -9.0Vdc (± 0.1 VDC).
- 4- Locate test point **TP20**. Check for a reading of -4.4VDC (± 0.3 Vdc), Adjust **VR12** (LIM CV) so that TP20 = -4.4 VDC
- 5- Turn audio generator/oscillator back on.
- 6- Make sure the output level at XLR "OP2" is still +4dBu, and the meter reading for "OP2" is "0" VU.
- 7- Move the limiting control to "MAX". Peak limiter red LED indicator should turn ON (± 1.0 dB). Decrease oscillator output level by 2dB. The LED indicator should turn OFF.
- 8- Return the limiting control back to "MIN". Restore oscillator output level back to +4dBu.
- 9- Use the VU meter select switch to read "GR".
- 10- Increase the oscillator output to +21dBu. The Peak limiter red LED indicator should turn ON (± 1.5 db). Decrease oscillator output level by 2dB. The LED indicator should turn OFF.

Note-1: if you do not have enough output level coming from your oscillator, then increase the signal level coming into the CORE by adjusting the INPUT LEVEL ATTENUATOR control. Bring up the input level attenuator until you have a reading of +21dBu at the output XLR "OP2".

Note-2: The Manley CORE Peak limiter section was designed to automatically "kick in" according to specific output levels at the main output "OP2".

When the LIMITING control knob is set at MIN the LIMIT threshold will be at +20dBu (± 1 dB)

When the LIMITING control knob is set at MAX the LIMIT threshold will be at +3.5dBu (± 0.5 dB)

16. Curves & Specifications

- ALL-TUBE preamplifier audio path using 1 x 12AX7WA for gain and 1 x 6922 White Follower
- Balanced Transformer Coupled XLR Microphone Input Impedance: 1250 Ohms
- Balanced XLR Line Input Impedance: 10 kOhms
- Unbalanced 1/4" Direct Input Impedance: 10 Meg Ohm
- Hi-current drive Direct Output Impedance: 50 Ohms
- Silent conductive plastic INPUT attenuator
- Compressor Maximum GAIN REDUCTION: 16 dB
- Compressor ATTACK time: 60ms slowest CCW, 30ms at 12:00, 5ms fastest CW for 6dB compression
- Compressor RELEASE time: 1.5s slowest CCW, 1s at 12:00, 100ms fastest CW from 6dB compression
- Limiter ATTACK time: 155µs
- Limiter RELEASE time: 300 ms slowest CCW, 150 ms at 12:00, 2.3 ms fastest CW
- Maximum Input Mic input (Low Gain Setting): -5 dBu or 435mV RMS @ 0.5% THD
- Maximum Input Mic input (High Gain* Setting): -25 dBu or 44mV RMS @ 0.5% THD
- Maximum Input Line input (Low Gain Setting): +13 dBu or 3.5V RMS @ 0.5% THD
- Maximum Input Line input (High Gain* Setting): -8 dBu or 300mV RMS @ 0.5% THD
- Maximum Input Direct input (Low Gain Setting): +24 dBu or 12V RMS @ 0.5% THD
- Maximum Input Direct input (High Gain* Setting): +17 dBu or 5.5V RMS @ 0.5% THD
- Maximum Input Insert return: +20 dBu or 7.8V RMS @ 0.5% THD
- Maximum Preamp Output (Insert Send): +35 dBu or 43V RMS @ 0.5% THD
- Maximum Preamp Output (Insert Send): +22 dBu into 600 Ohms
- Maximum Main Output: +20 dBu
- Insert Send output impedance: 50 Ohms
- Insert Return input impedance: 13 kOhms
- Main Output Impedance: 50 Ohms
- Direct Output Headroom (referenced to +4 dBu): 31 dB
- Main Output Headroom (referenced to +4 dBu): 16 dB
- Dynamic Range: >90 dB
- Frequency Response: 10 Hz to 75 kHz -0.15dB, -0.5 dB
- Large LED illuminated VU METER
- Meters switch to read Direct Output (1) from preamp, Output (2) from Main Out, or Compressor Gain Reduction
- THD & Noise (1kHz @ +4 dBm): 0.02% at Low Gain setting
- Noise Floor Micpre (A WGT): -84dB @ LOW GAIN, -64dB *HI GAIN
- EIN (A WGT): -124dBu 22-22kHz BW, 40dB gain, with 150 Ohm source impedance
- Gain via Microphone Input: 40 LOW or 50/60 dB *HI GAIN
- Gain via Line Input: 20 or 30/40dB *HI GAIN
- Maximum Gain of EQ & Limiter section: 10 dB
- Noise Floor Insert Return to OP2: -90dBu BW: 22Hz - 22kHz
- AUTOMUTE warmup delay: 30 seconds
- Power consumption: 35 Watts
- Operating mains voltage: 90 to 254 VAC (internal universal supply)
- Mains Voltage Frequency: 50-60Hz
- Dimensions: 19" x 3 1/2" x 7" (occupies 2u)
- Unit weight: 8.3 lbs.
- Shipping weight: 11.5 lbs.

*HIGH GAIN when referred to is @ 60dB unless otherwise stated. This relates to whether the internal HI GAIN jumper is either set to an extra 10dB or 20dB of gain.

EQ SHELF

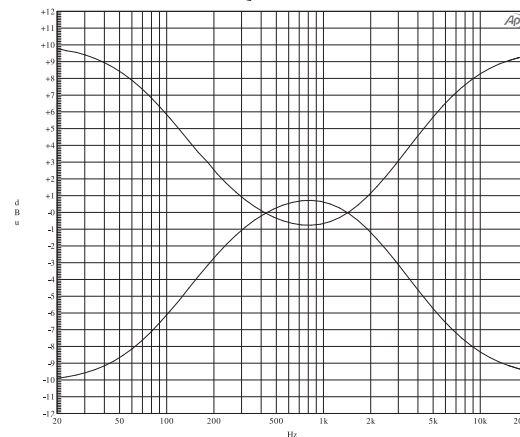

MID EQ PLOT

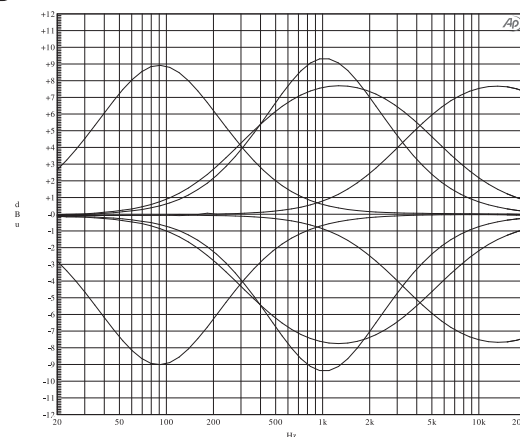

LIMITER, MIN, MED, MAX

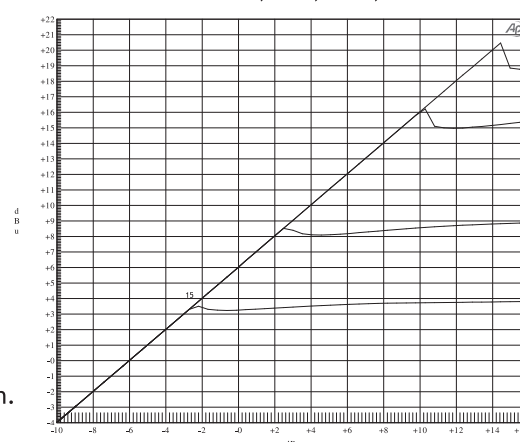

17. Recall Sheet



MANLEY
CORE
REFERENCE CHANNEL STRIP
OP 2
OP 1 GR

INPUT LEVEL
MIC 120Hz HI 48V 180°
LINE FLAT LOW PHANTOM 0
HANDCRAFTED IN CALIFORNIA USA
DIRECT IN

COMPRESSION
ATTACK
SLOW IN
FAST IN
BYPASS
RELEASE
SLOW FAST
COMPRESSION

LOW -12 dB +12
100Hz-1kHz
1kHz-10kHz
-10 dB +10
-12 dB +12
HI

FREQUENCY
MIN (C/E) MAX

LIMITING
LIMIT
RELEASE
SLOW FAST
LIMITER

UNITY
OUTPUT GAIN
-6 dB +4

20 10 7 5 3 2 1 0 1 2 3
100 80 60 40 20

ARTIST _____ INSTRUMENT / TRACK _____ DATE _____
 SONG _____ MIC NOTES _____ ENGINEER _____

MANLEY
CORE
REFERENCE CHANNEL STRIP
OP 2
OP 1 GR

INPUT LEVEL
MIC 120Hz HI 48V 180°
LINE FLAT LOW PHANTOM 0
HANDCRAFTED IN CALIFORNIA USA
DIRECT IN

COMPRESSION
ATTACK
SLOW IN
FAST IN
BYPASS
RELEASE
SLOW FAST
COMPRESSION

LOW -12 dB +12
100Hz-1kHz
1kHz-10kHz
-10 dB +10
-12 dB +12
HI

FREQUENCY
MIN (C/E) MAX

LIMITING
LIMIT
RELEASE
SLOW FAST
LIMITER

UNITY
OUTPUT GAIN
-6 dB +4

20 10 7 5 3 2 1 0 1 2 3
100 80 60 40 20

ARTIST _____ INSTRUMENT / TRACK _____ DATE _____
 SONG _____ MIC NOTES _____ ENGINEER _____



Designed & Handcrafted in USA

Manley Laboratories, Inc.
13880 Magnolia Avenue
Chino, CA 91710 USA
T: +1 (909) 627-4256

www.manley.com

OPERATIONAL BLOCK DIAGRAM

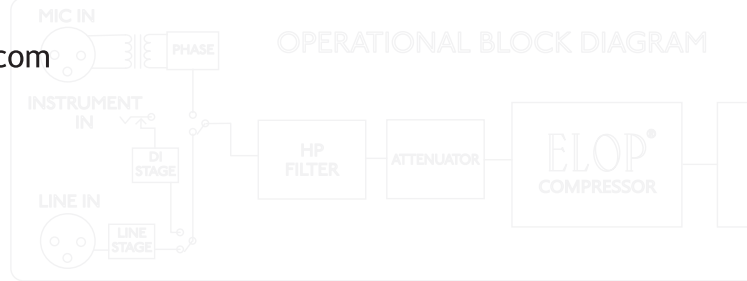

MANLEY LABORATORIES INC.
13880 MAGNOLIA AVE. CHINO, CA 91710
PHONE: +1 (909) 627-4256

MAIN OUTPUT (2)

