



## ***User's Manual***

# iA

## INSTALLATION POWER AMPLIFIER



Antes de utilizar el equipo, lea la sección "Precauciones de seguridad" de este manual. Conserve este manual para futuras consultas.

Before operating the device, please read the "Safety precautions" section of this manual. Retain this manual for future reference.

## CONTENTS

<b>SAFETY PRECAUTIONS</b> .....	<b>3</b>
<b>WARRANTY</b> .....	<b>4</b>
<b>DECLARATION OF CONFORMITY</b> .....	<b>5</b>
<b>INTRODUCTION</b> .....	<b>6</b>
<b>FRONTAL PANEL</b> .....	<b>6</b>
<b>REAR PANEL</b> .....	<b>7</b>
<b>INSTALLATION</b> .....	<b>8</b>
<b>USE</b> .....	<b>9</b>
<b>SPECIFICATIONS</b> .....	<b>10</b>
<b>LINE DRAWINGS</b> .....	<b>10</b>
<b>CONFIGURATIONS</b>	
IA-404 low impedance .....	<b>11 - 13</b>
IA-404 high impedance .....	<b>14</b>
IA-404 hybrid low and high impedances .....	<b>15</b>
IA-1004 low impedance .....	<b>16 - 17</b>
IA-1004 high impedance .....	<b>18</b>
IA-1004 hybrid low and high impedances .....	<b>19</b>
IA-402 low impedance .....	<b>20</b>
IA-402 high impedance .....	<b>21</b>
IA-1002 low impedance .....	<b>22</b>
IA-1002 high impedance .....	<b>23</b>
<b>TROUBLESHOOTING</b> .....	<b>24</b>
<b>ANNEX: Line connections: unbalanced and balanced</b> .....	<b>25</b>



### Amplificadores de Potencia para sistemas distribuidos / Power Amplifiers for distributed systems

Conserve y lea estas instrucciones.

Respete y siga todas las advertencias.

El signo de exclamación en un triángulo equilátero pretende alertar al usuario de instrucciones operativas y de mantenimiento (reparación) en la literatura que acompaña al aparato.

ADVERTENCIA: Los aparatos de CLASE I se deben conectar a una toma de corriente eléctrica con conexión a tierra.



El rayo con punta de flecha dentro de un triángulo equilátero pretende alertar al usuario de la presencia de voltajes peligrosos no aislados. Para reducir el riesgo de choque eléctrico no retire la cubierta. No existen partes ajustables en el interior.



ADVERTENCIA: Para evitar lesiones, este aparato debe estar firmemente sujeto al bastidor, de conformidad con las instrucciones de instalación.



El cableado exterior conectado a estos terminales requiere de su instalación por una persona instruida y el uso de cables flexibles preparados.

No exponga este equipo a la lluvia o humedad. No use este aparato cerca del agua (piscinas y fuentes, por ejemplo). No exponga el equipo a salpicaduras ni coloque sobre él objetos que contengan líquidos, tales como vasos y botellas. Equipo IP-20. Limpie con un paño seco. No use limpiadores con disolventes.

No instale el aparato cerca de fuentes de calor tales como radiadores, estufas u otros aparatos que produzcan calor. No bloquee las aberturas de ventilación, e instale de acuerdo con las instrucciones del fabricante. Los ventiladores de refrigeración toman aire fresco de un lateral y sale caliente por el otro lateral de la unidad a través de las rejillas de ventilación. Los laterales del amplificador deben estar expuestos al aire (por ejemplo, en un rack con rejillas), con cámara de aire de 5 cm a los lados. SI AL AIRE NO SE LE PERMITE CIRCULAR, SE SOBRECALENTARÁ LA UNIDAD. Tenga cuidado al montar otro equipo en el mismo rack. Diseñado para funcionar entre 15°C y 45°C, con el 75% de humedad relativa máxima.



Desconecte este aparato durante tormentas eléctricas, terremotos o cuando no se vaya a emplear durante largos períodos.

Tenga en cuenta que la tensión nominal de alimentación es el valor indicado en la etiqueta, con un rango  $\pm 10\%$  de ese valor (según IEC 60065:2001).

Proteja el cable de alimentación de ser pisado o aplastado, especialmente en los enchufes, receptáculos y en el punto en el que salen del aparato. Confíe las reparaciones a personal cualificado. Se requiere servicio cuando el aparato ha sido dañado de alguna manera, como por ejemplo si el cable de alimentación o el enchufe está dañado, se ha derramado líquido o han caído objetos dentro del aparato, el aparato ha sido expuesto a la lluvia o la humedad, no funciona con normalidad o se ha caído. El interruptor de alimentación deberá permanecer fácilmente accesible. Para desconectar completamente este aparato de la red eléctrica, desconecte el cable de alimentación del interruptor de corriente principal. Esta unidad está equipada con un cable de alimentación de 3 hilos. Por razones de seguridad, LA CONEXIÓN A TIERRA NO DEBE DESCONECTARSE EN NINGUNA CIRCUNSTANCIA.



Cuando la unidad esté montada en un rack y permanentemente conectada a red debe ser instalada con un conector de fácil acceso o con un dispositivo de desconexión omnipolar con al menos 3 mm de distancia entre sus contactos. El interruptor de los amplificadores sólo afecta a uno de los polos de la red eléctrica, por tanto, en las unidades con un cable desmontable el dispositivo de desconexión de red (por ejemplo, el enchufe o la conexión a red), debe ser fácilmente accesible para poder estar completamente desconectado de la red. Sin embargo, en unidades con cable fijo deberá usar un dispositivo de desconexión externo (antes descrito). La instalación deberá seguir todas las normas de instalación vigentes.

Utilice sólo accesorios (por ejemplo, soportes o racks) recomendados por el fabricante. Cuando se utiliza un rack o un carro de transporte, tenga cuidado al mover la combinación carro / aparato para evitar lesiones causadas por un vuelco.



Este símbolo indica que el presente producto no puede ser tratado como residuo doméstico normal, sino que debe entregarse en el correspondiente punto de recogida de equipos eléctricos y electrónicos.



Keep these instructions. Read these instructions.

Heed all warnings. Follow all instructions.

The exclamation point within an equilateral triangle is intended to alert the user of important operating and maintenance (servicing) instructions in the literature accompanying the appliance.

WARNING: Apparatus with CLASS I construction shall be connected to a MAINS socket outlet with a protective earthing connection.

The lightning flash with arrowhead symbol within an equilateral triangle is intended to alert the user to the presence if uninsulated "dangerous voltage". To reduce the risk of electric shock do not remove the cover. No user serviceable parts inside.

WARNING: To prevent injury, this apparatus must be securely attached to the rack in accordance with the installation instructions.

The connected outer wiring to these terminals requires of its installation by an instructed person and the use of a flexible cable already prepared.

Do not expose this device to rain or moisture. Do not use this apparatus near water (for example, swimming pools and fountains). Do not place any objects containing liquids, such as bottles or glasses, on the top of the unit. Do not splash liquids on the unit. IP-20 equipment. Clean only with a dry cloth. Do not use any solvent based cleaners.

Do not install near any heat sources such as radiators, stoves or other apparatus that produce heat. Do not block any ventilation openings, install in accordance with the manufacturer's instructions.

The cooling fans push cool air through one side and blow hot air out of the other side of the unit through the ventilating grilles.

Do not block the sides of the amplifier (i.e. in a rack with grilles). Allow an air flow gap of 5cm or more on the sides. IF THE AIR IS NOT ALLOWED TO CIRCULATE, OVERHEATING WILL OCCUR.

Take care when mounting other equipment in the same rack. Working temperature ranges from 15°C to 45°C with a maximum relative humidity of 75%.

Unplug this apparatus during lightning storms, earthquakes or when unused for long periods of time.

Take into account that the nominal AC voltage is the value shown in the equipment  $\pm 10\%$  (according to IEC 60065:2001).

Protect the power cord from being walked on or pinched particularly at plugs, convenience receptacles and the point where they exit from the apparatus.

Refer all servicing to qualified service personnel. Servicing is required when the apparatus has been damaged in any way, such as if the power-supply cord or plug is damaged, liquid has been spilled or objects have fallen into the apparatus, the apparatus has been exposed to rain or moisture, does not operate normally, or has been dropped.

The mains circuit breaker shall remain readily accessible.

To completely disconnect this equipment from the AC mains, disconnect the power cord from the mains circuit breaker.

This unit is fitted with a 3-wire power cord. For safety reasons, THE EARTH LEAD SHOULD NOT BE DISCONNECTED UNDER ANY CIRCUMSTANCES.

Where the amplifier is mounted in a rack and permanently connected to the mains, then the rack should be installed with a readily accessible connector or an ALL POLE circuit breaker with 3mm breaking distances.

The mains switch on the amplifiers only switches one pole of the mains supply, therefore for units with a detachable cord to be fully disconnected from the mains, the mains disconnect device (ie mains plug or mains coupler) should remain readily operable. For units with a fixed mains lead the external all pole circuit breaker with 3mm breaking distances is the disconnect device and therefore the installation of the amplifier shall be carried out in accordance with all the applicable installation rules.

Only use attachments/accessories specified by the manufacturer. Use only with the cart, tripod, bracket or table specified by the manufacturer, or sold with the apparatus. When a cart is used, use caution when moving the cart/apparatus combination to avoid injury from a tip over.

This symbol on the product indicates that this product should not be treated as household waste. Instead it shall be handed over to the applicable collection point for the recycling of electrical and electronic equipment.

## **GARANTÍA**

Todos nuestros productos están garantizados por un periodo de 24 meses desde la fecha de compra.

Las garantías sólo serán válidas si son por un defecto de fabricación y en ningún caso por un uso incorrecto del producto.

Las reparaciones en garantía pueden ser realizadas, exclusivamente, por el fabricante o el servicio de asistencia técnica autorizado.

Otros cargos como portes y seguros, son a cargo del comprador en todos los casos.

Para solicitar reparación en garantía es imprescindible que el producto no haya sido previamente manipulado e incluir una fotocopia de la factura de compra.

## **WARRANTY**

All our products are warranted against any manufacturing defect for a period of 2 years from date of purchase.

The warranty excludes damage from incorrect use of the product.

All warranty repairs must be exclusively undertaken by the factory or any of its authorised service centers.

To claim a warranty repair, do not open or intend to repair the product.

Return the damaged unit, at shippers risk and freight prepaid, to the nearest service center with a copy of the purchase invoice.



## DECLARACIÓN DE CONFORMIDAD DECLARATION OF CONFORMITY

### **DAS Audio Group, S.L.**

C/ Islas Baleares, 24 - 46988 - Pol. Fuente del Jarro - Valencia. España  
(Spain).

Declara que la *serie iA*:

Declares that *iA series*:

Cumple con los objetivos esenciales de las Directivas:

Abide by essential objectives relating Directives:

- Directiva de Baja Tensión (Low Voltage Directive) 2014/35/UE
- Directiva de Compatibilidad Electromagnética (EMC) 2014/30/UE
- Directiva RoHS 2011/65/UE
- Directiva RAEE (WEEE) 2012/19/UE

Y es conforme a las siguientes Normas Armonizadas Europeas:

In accordance with Harmonized European Norms:

- EN 60065:2014.- Audio, video and similar electronic apparatus. Safety requirements.
- EN 55032:2012.- Electromagnetic compatibility of multimedia equipment. Emission requirements.
- EN 55103-2:2009.- Electromagnetic compatibility. Product family standard for audio, video, audio-visual and entertainment lighting control apparatus for professional use. Part 2:Immunity.
- EN 50581:2012.- Technical documentation for the assessment of electrical and electronic products with respect to the restriction of hazardous substances.

## INTRODUCTION

### General

Thank you for purchasing DAS iA series power amplifiers. They have been designed with the latest and most advanced Class D technology. As a result, a family of multi channel high efficiency, universal mains, amplifiers has been created for small/medium sized applications.

### Features

- 2 or 4 channel models
- Class D, switching power supply
- Universal Mains regulated power supply
- Selectable Low or High Impedance operation
- Integrated limiter to prevent amplifier clip
- Integrated optional High Pass Filter at 80Hz
- Independent Volume controls per channel
- Power On led and dual color Signal/Clip leds per output channel
- Thermal protection
- Over current protection
- Built in DC protection
- Short Circuit protection
- Stereo (low impedance) and Bridge (high impedance) modes
- Ultra light weight
- Terminal block input&output connectors

## FRONT PANEL



### A) Power Switch

Turns the amplifier on ("I" position) and off ("0" position). When the amplifier is turned on the "power" LED will illuminate.

### B) Power / Standby / Protection LED

A green color LED shows that the amplifier is ON.

A red color LED shows that the amplifier is in standby mode.

An orange color LED shows protection mode.

Protection mode may be triggered by:

- Overheating: Temperature protection will be enabled if either the internal power supply, transformer or one of the two amplifier channels become too hot due to inadequate cooling. When the amplifier has cooled down the channel's output will be activated and operation will continue.

- The iA series has a built-in DC protection feature. The DC protection will help to protect the loudspeaker from excess damage in case of an attempt to deliver a DC voltage out of the amplifier. This could happen either because the DC voltage on the input of the amplifier is too high or if the unit has an internal defect.

If a consistent DC voltage is present at the output of the unit, the amplifier will enter a latching shutdown. Only a re-cycle of the mains voltage will restart the amplifier.

If the DC voltage on the amplifier output is due to an excessively high DC voltage pulse on the input of the amplifier the unit will attempt 3 times re-activate before latching shutdown.

- The iA series has a built-in current limitation to protect against overloading of the amplifier power stage. The current limitation will allow maximal current of typically 30Apeak during audio peaks without disabling the amplifier. If an external clip-limiter has not been implemented or if an external clip-limiter is not capable of limiting the output current enough, (e.g. if a permanent short is loading the amplifier), the amplifier will disable to protect itself.

The current limit is depending on the temperature of the amplifier power stage. The higher the temperature – the lower the current limit for optimal protection of the amplifier.

- The iA series monitors their internal rail voltages to prevent overloading of internal components, and to ensure proper operation of the onboard amplifiers.

### Overvoltage

In case voltage is too high on the internal rail voltages, the unit will Disable/Mute the amplifiers and temporarily shut down, to prevent damage of the internal components.

### Undervoltage

In case that the amplifier internal rails drop to a very low level, the unit will Disable/Mute the two amplifier channels, to ensure correct operation of the amplifiers. Once the internal rail voltages rises to a normal level again, the amplifier channels will be re-enabled.

### C) Output channels Volume Controls

Volume levels for each channel can be adjusted by using the knobs on the front panel. Gain is maximum when the level of the rotary potentiometer is rotated fully clockwise.

### D) Signal / Clip LED

These LEDs show the presence of signal at the amplifier's inputs and is dependent on the position of the level control. In the event that the signal input level exceeds the amplifier's input sensitivity the clip LEDs will light in orange (soft clip) or red (hard clip).

# REAR PANEL

1U models

iA-402



iA-404



2U models

iA-1002

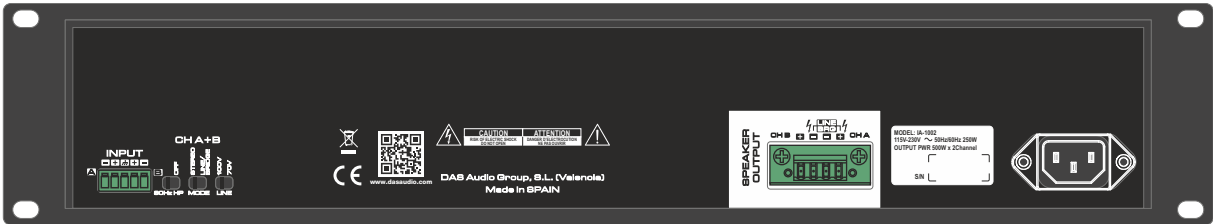

iA-1004

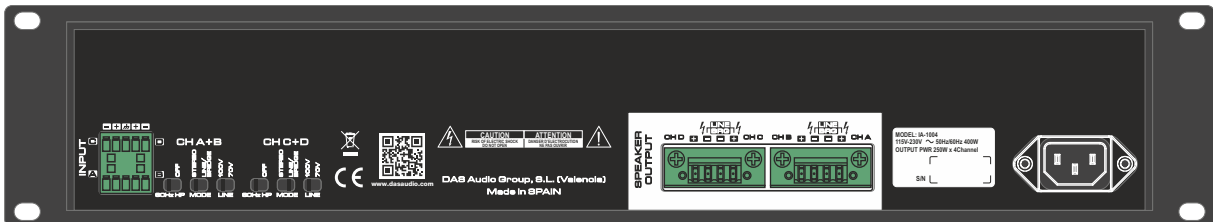

## A) Speaker outputs

Terminal Block (pitch 5,08mm) connectors with 4 pins are provided with the unit. Both stereo and bridge (100/70V) connections are available.

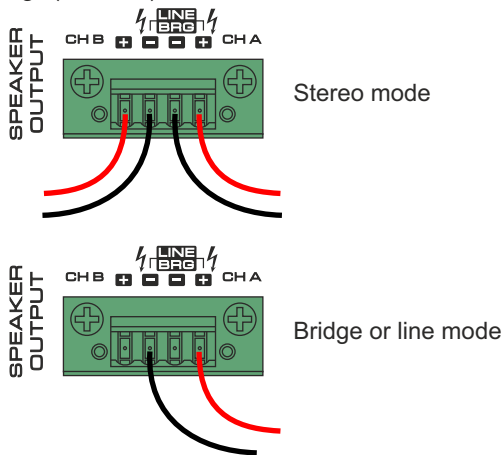

## C) Mode Switch

This switch allows the selection for the input configuration mode: stereo or bridge (100/70V line).

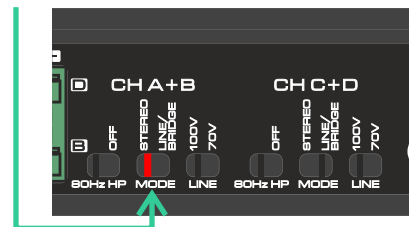

Typically the amplifiers are used in stereo mode, where the input A feeds channel A and the input B feeds channel B.

Use the Bridge mode to use the power of two channels for one single output. Use Bridge mode to connect cabinets with 100/70V transformers directly to the amplifier's output. In bridge mode inputs B and D are disabled, use inputs A and C:

## B) Inputs

Terminal Block (pitch 3,5mm) connectors with 5 pins are provided with the unit.

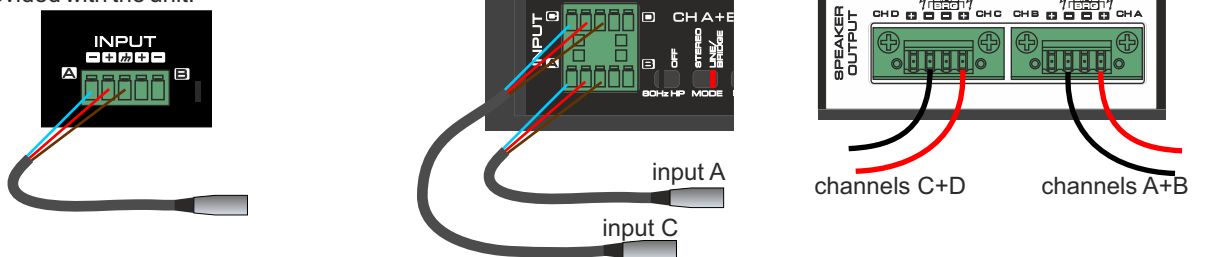

# INSTALLATION

## Racking

There are two 1U DIN high models (IA-402/404) and two 2U DIN high models (IA-1002/1004). All units are of a standard 19-inch rack mount width.

Four front panel mounting holes are provided for use with M5 or M6 screws.

Amplifier dimensions can be found on the "Line Drawings" section in this manual.

## Cooling

The amplifiers use a fan located on one of their side panels to maintain the unit under stable conditions. The fans are intelligently managed by a micro controller varying their speed according to the needs.

Air inlets are located on one side of the amplifier. Do not block them at any time.

The side walls of the rack should be a minimum of 2 inches (5 cm) from the amplifier sides. The back of the rack should be open.

## Input cable connections

DAS Audio recommends using prebuilt or professionally wired balanced line (two-conductor plus shield) 2x0.22mm<sup>2</sup> or 22-24 AWG cables to connect the amplifier balanced input by using the included 3.5mm pitch terminal block connectors.

Custom wiring should only be performed by qualified personnel.

## Speaker cable connections

5.08mm pitch, 4 pin, terminal block connectors are used to connect the speakers:

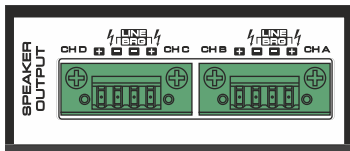

The iA series amplifiers can work in stereo mode or bridge mode. If 2 channels are bridged, the unit can be used for 100/70V lines (high impedance).

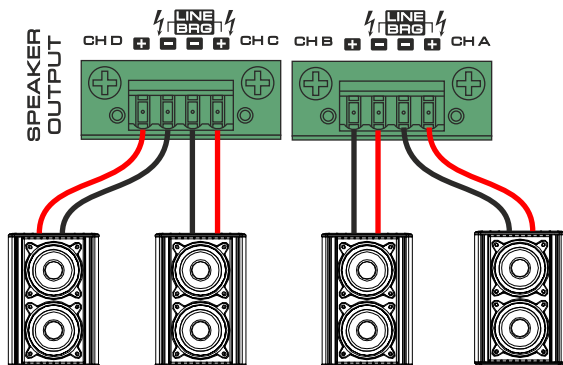

Select 8 ohm impedance position  
Stereo mode - four channels

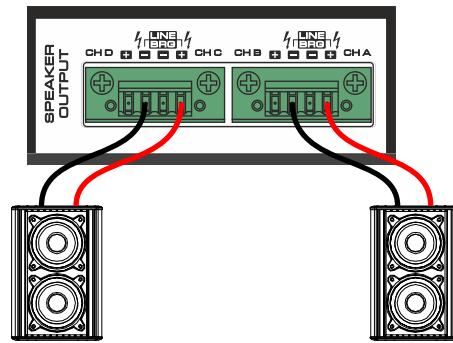

Select transformer tap position (10/20/30W)  
Bridge mode - two 100/70V channels

DAS Audio recommends using prebuilt or professionally wired, high-quality, two-conductor, heavy gauge speaker wire. Speakers wires should be twisted cable, if possible. To prevent the possibility of short-circuits, the wires should be stripped back no greater than 6 mm (1/4 inch).

The maximum cable length of the line (100/70V) will be determined by the gauge (section) of the cable and the total power of the line.

A cable loss of less than 10% (around 1dB) would be a very good limit.

For the most common cable sizes we can find these values as a reference (copper cables):

L(m)	AWG	S(mm <sup>2</sup> )	200W	400W	500W	1000W
10	16	1,3	-0,05	-0,1	-0,12	-0,24
10	14	2,1	-0,03	-0,06	-0,075	-0,15
10	12	3,3	-0,018	-0,037	-0,047	-0,1
25	16	1,3	-0,12	-0,24	-0,3	-0,6
25	14	2,1	-0,075	-0,14	-0,18	-0,36
25	12	3,3	-0,05	-0,1	-0,12	-0,23
50	16	1,3	-0,24	-0,47	-0,6	-1,12
50	14	2,1	-0,18	-0,3	-0,36	-0,7
50	12	3,3	-0,1	-0,18	-0,23	-0,46
75	16	1,3	-0,35	-0,7	-0,85	-1,7
75	14	2,1	-0,22	-0,43	-0,54	-1,05
75	12	3,3	-0,14	-0,28	-0,34	-0,68

L(m)	AWG	S(mm <sup>2</sup> )	200W	400W	500W	1000W
10	16	1,3	-0,1	-0,2	-0,24	-0,48
10	14	2,1	-0,06	-0,12	-0,15	-0,3
10	12	3,3	-0,036	-0,074	-0,094	-0,2
25	16	1,3	-0,24	-0,48	-0,6	-1,2
25	14	2,1	-0,15	-0,28	-0,36	-0,72
25	12	3,3	-0,1	-0,2	-0,24	-0,46
50	16	1,3	-0,48	-0,94	-1,2	-2,24
50	14	2,1	-0,36	-0,6	-0,72	-1,4
50	12	3,3	-0,2	-0,36	-0,46	-0,92
75	16	1,3	-0,7	-1,4	-1,7	-3,4
75	14	2,1	-0,44	-0,86	-1,08	-2,1
75	12	3,3	-0,28	-0,56	-0,68	-1,36

## Connection to mains

Nominal AC voltage is 230V. Export versions may operate at 115V. keep in mind that the power supplies used are universal mains.

Connect your amplifier to the AC mains power source (power outlet) with the supplied AC power cord. First, connect the IEC end of the cord set to the IEC connector on the amplifier; then, plug the other end of the cord set to the AC mains.

**WARNING:** The third prong of this connector (ground) is an important safety feature. Do not attempt to disable this ground connection by using an adapter or other methods.



## Current draw

The measured consumption at 1/3 of the power rating represents the worst case scenario in order to dimension the installation.

At 230V these are the values:

IA-402/404: 1.52A(7A at 115V)

IA-1002/1004: 1.75A(3.5A at 115V)

## USE

### Switch ON/OFF

Switch your sound system on from back to front. Thus, switch on the amplifiers last on your sound system. Switch sound sources (Cds, turntables) first, then your mixer, then your processors and finally the amplifiers. If you have more than one amplifier switch them sequentially, one at a time.

Follow the reverse order when switching off and switch off the amplifiers before any other element in your sound system.

### Clip Led (also signal led)

The clip led should never be on continuously (red). The amplifiers integrate their own limiters to avoid severe amplifier clipping and reduce distortion, but the dynamic nature of music signals could make the amplifiers clip. Thus at most, the clip light could be lit occasionally.

### Level controls

The level rotary potentiometer is used for changing the input gain. With the levels at maximum the amplifier Gain is 32dB.

Although related to output power, it is not a direct representation of it. Thus, we can have the maximum output power with the level control at mid position and with a higher input signal level. Similarly, we may have the gain controls at maximum and not have maximum output if the input signal level is below amplifier's input sensitivity.

### Standby mode

To save energy, the unit is designed to go into standby mode after approximately 10minutes with no signal at any of the inputs. Return of signal to any input will reactivate the unit again.

## SPECIFICATIONS

Model	IA-402	IA-404	IA-1002	IA-1004
Output power Stereo Mode				
4 ohm	2 x 200W	4 x 100W	2 x 500W	4 x 250W
8 ohm	2 x 100W	4 x 50W	2 x 250W	4 x 125W
Output power Bridge Mode				
8 ohm	1 x 400W	2 x 200W	1 x 1000W	2 x 500W
100/70V	1 x 400W	2 x 200W	1 x 1000W	2 x 500W
THD+N(%) 4ohm 1kHz full power	0.08	0.08	0.08	0.08
Amplifier Gain dB	32 (40x)	32 (40x)	32 (40x)	32 (40x)
Frequency response - 20Hz to 30kHz (dB)	0 / -0.5	0 / -0.5	0 / -0.5	0 / -0.5
Input Impedance - Active balanced (k ohms)	20	20	20	20
Input Sensitivity (V/dBu)	1.32/4.6	1.32/4.6	1.32/4.6	1.32/4.6
AC power requirements	1.52A @ 230V (3.04 @ 115V)		1.75A @ 230V (3.5 @ 115V)	
Dimensions (H x W x D)	44.2 x 483 x 208mm (1.74 x 19 x 8.2 in)		88.4 x 483 x 208mm (3.48 x 19 x 8.2 in)	
Weight	2.7 kg (5.9 lb)	2.9 kg (6.4 lb)	3.5 kg (7.7 lb)	3.7 kg (8.2 lb)

**DAS Audio Group, S.L.** continuously strives to enhance its products through investigation and development. All specifications are subject to change without prior warning.

## LINE DRAWINGS

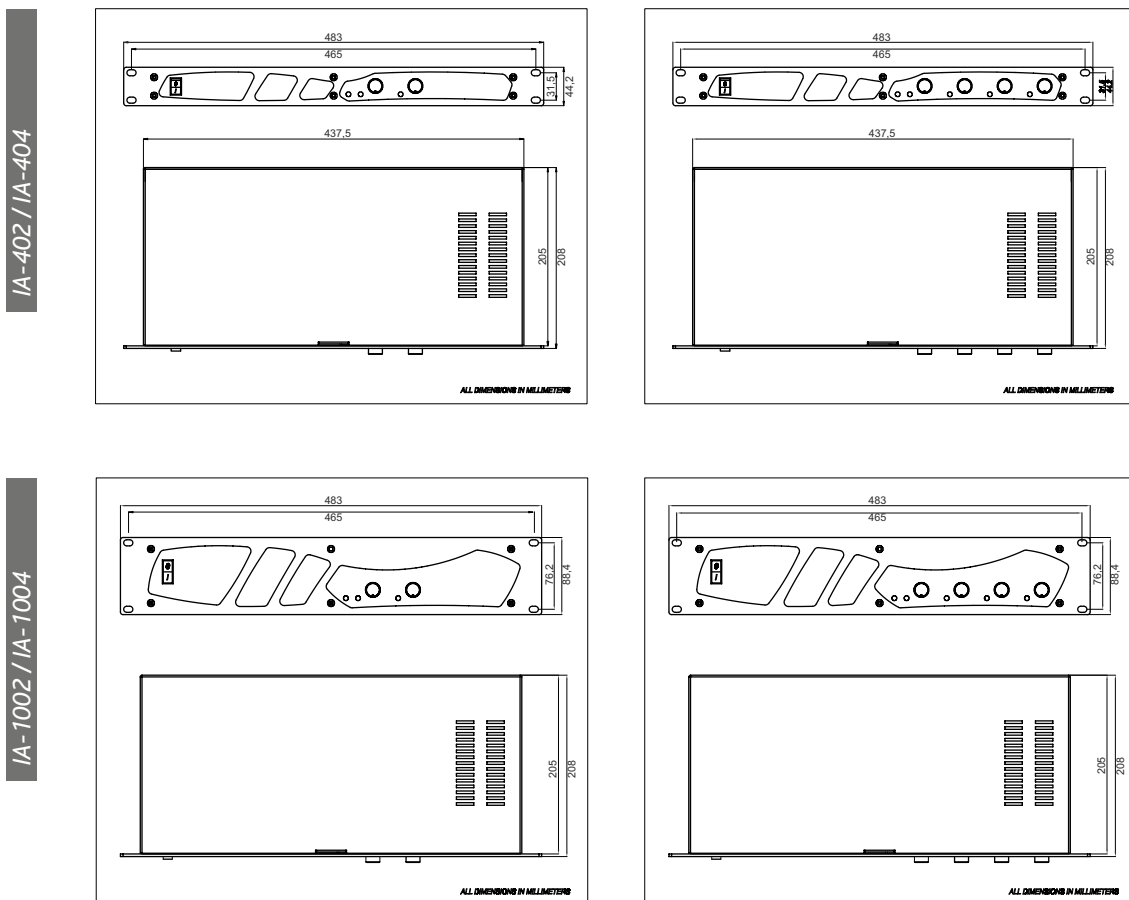

# iA-404

## Low Impedance Configuration

### ARCO-4-T + ARCO-12SUB

All Amplifier Channels in Stereo Mode for low impedance operation

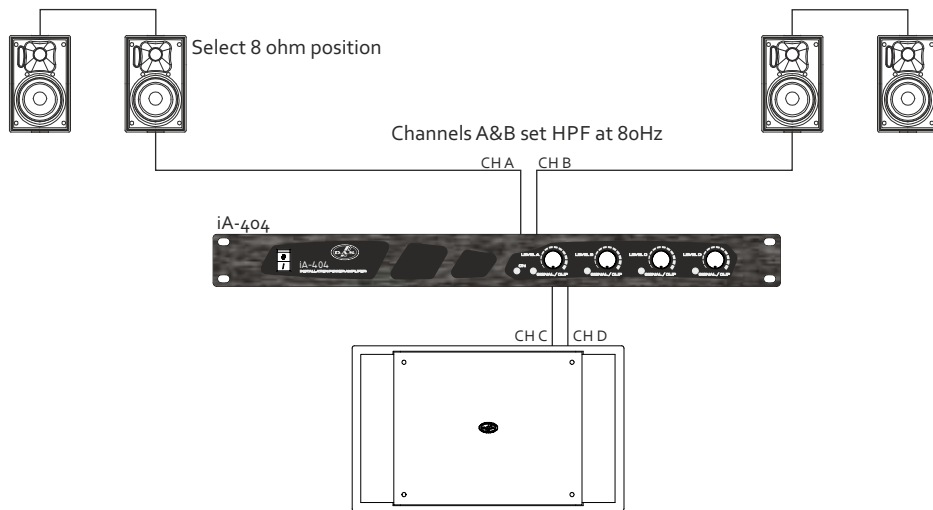

### ARCO-24-T + ARCO-12SUB

All Amplifier Channels in Stereo Mode for low impedance operation

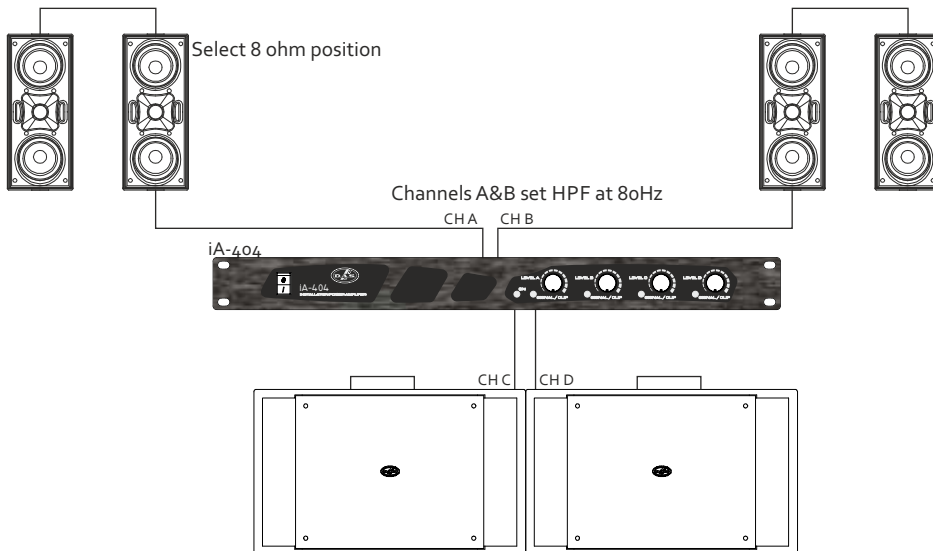

### ARTEC-306/ARTEC-308 + ARCO-12SUB

All Amplifier Channels in Stereo Mode for low impedance operation

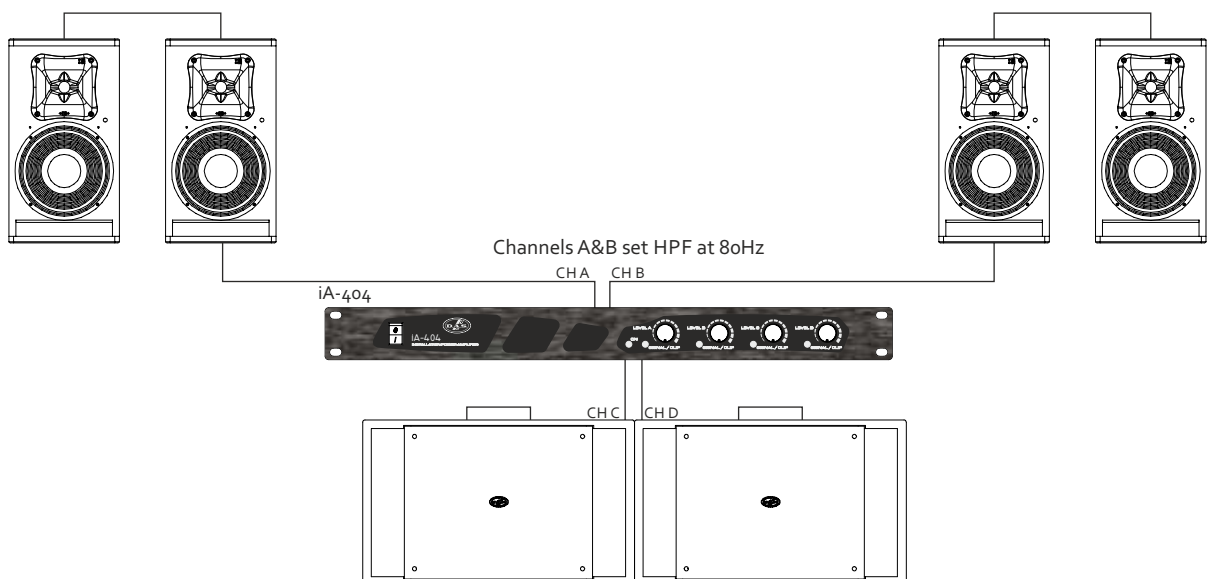

# iA-404

## Low Impedance Configuration (cont'd)

### Quantum Q-3-T + ARCO-12SUB

All Amplifier Channels in Stereo Mode for low impedance operation

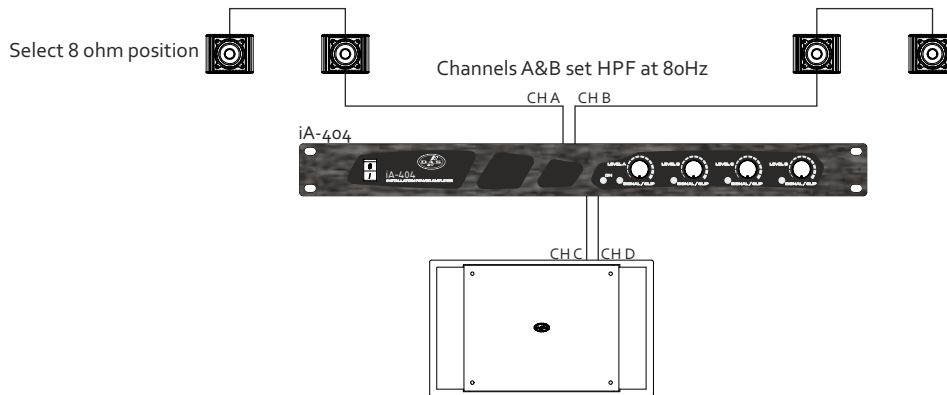

### Quantum Q-23-T + ARCO-12SUB

All Amplifier Channels in Stereo Mode for low impedance operation

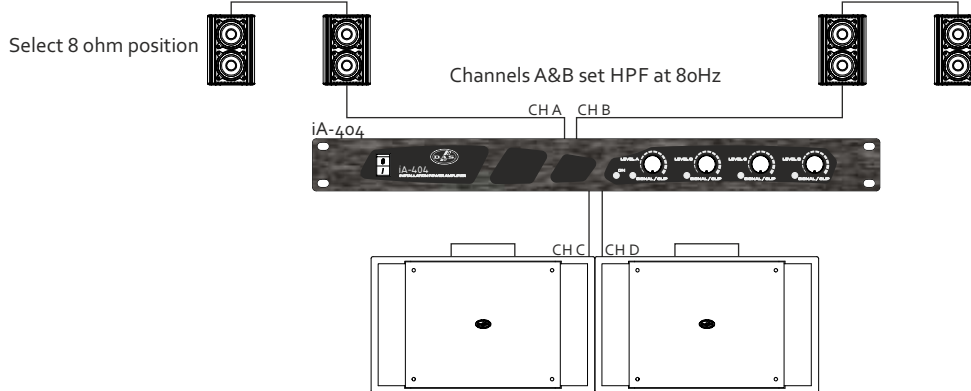

### Quantum Q-43-T

All Amplifier Channels in Stereo Mode for low impedance operation

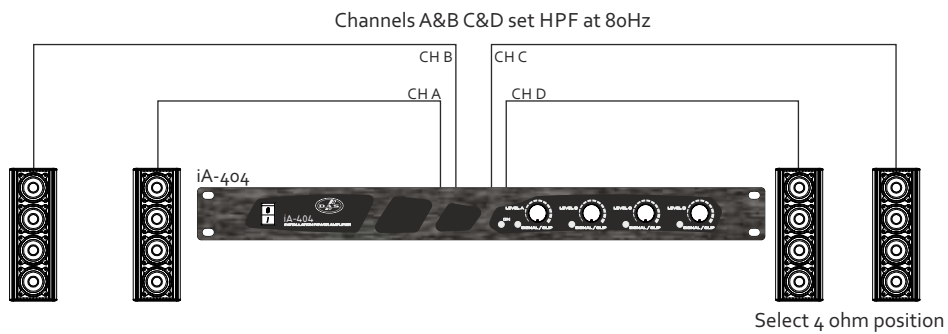

### Quantum Q-43-T + ARCO-12SUB

All Amplifier Channels in Stereo Mode for low impedance operation

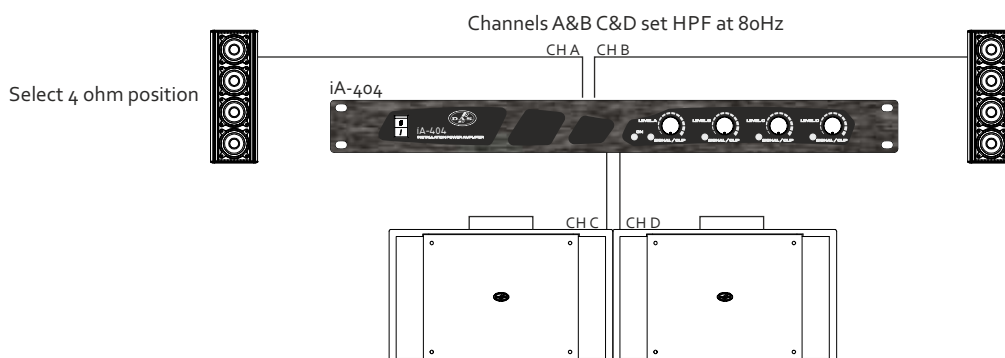

# iA-404

## Low Impedance Configuration (cont'd)

### ARCO-24-T

All Amplifier Channels in Stereo Mode for low impedance operation

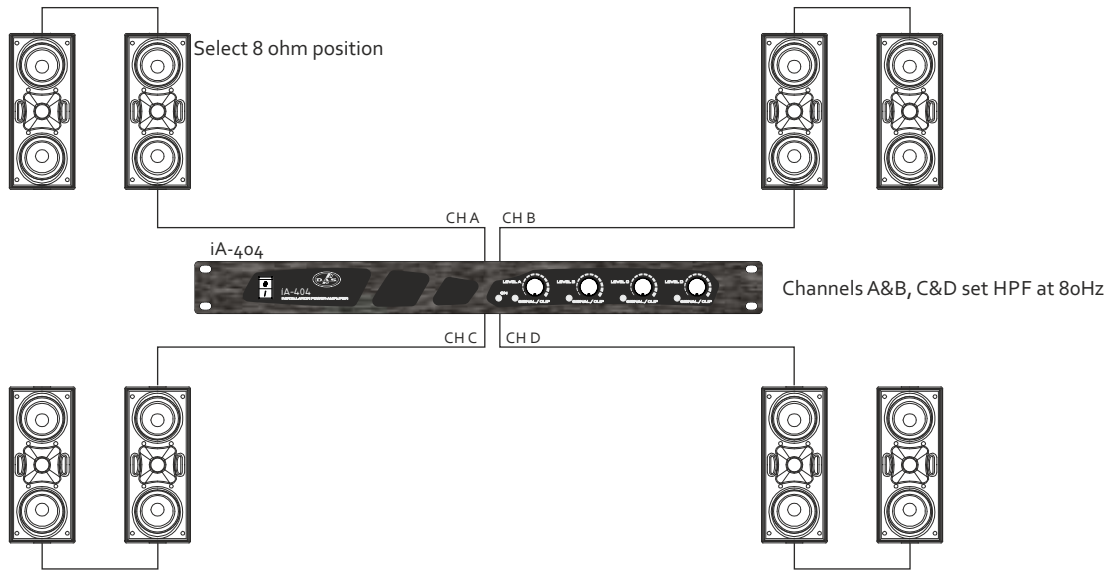

# iA-404

## High Impedance Configuration

### ARCO-4-T

All Amplifier Channels in Bridge Mode for high impedance operation  
Max power available 200W per channel (20 x arco-4T at 10W)

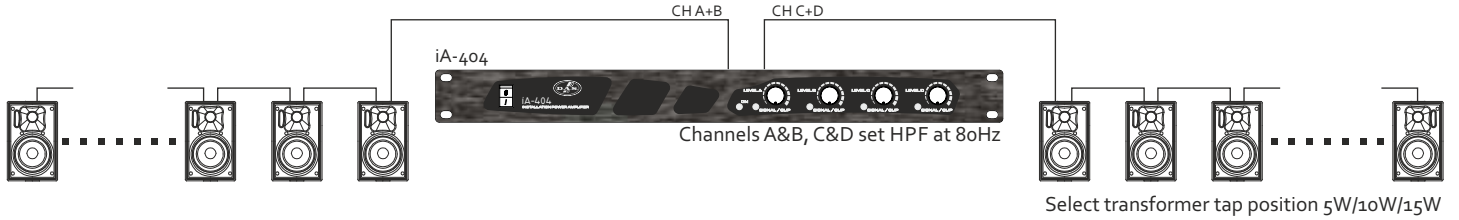

### ARCO-24-T

All Amplifier Channels in Bridge Mode for high impedance operation  
Max power available 200W per channel (10 x arco-24T at 20W)

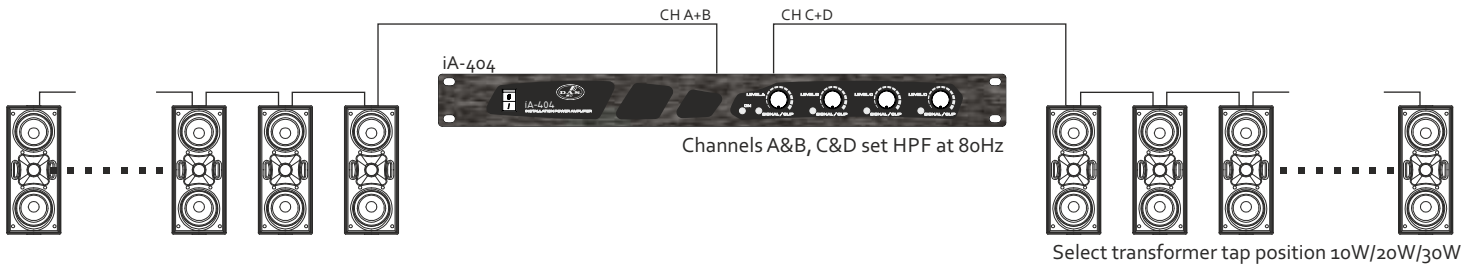

### Ceiling series

All Amplifier Channels in Bridge Mode for high impedance operation  
Max power available 200W per channel (6 x CL-8T at 30W)

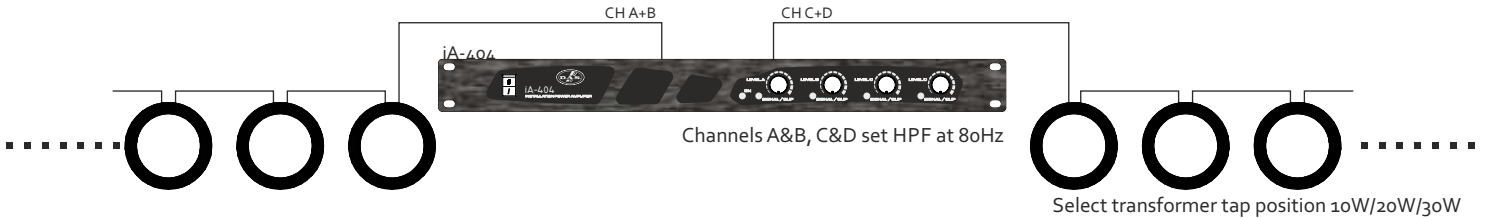

### Quantum Q-23-T

All Amplifier Channels in Bridge Mode for high impedance operation  
Max power available 200W per channel (20 x Q-23i at 10W)

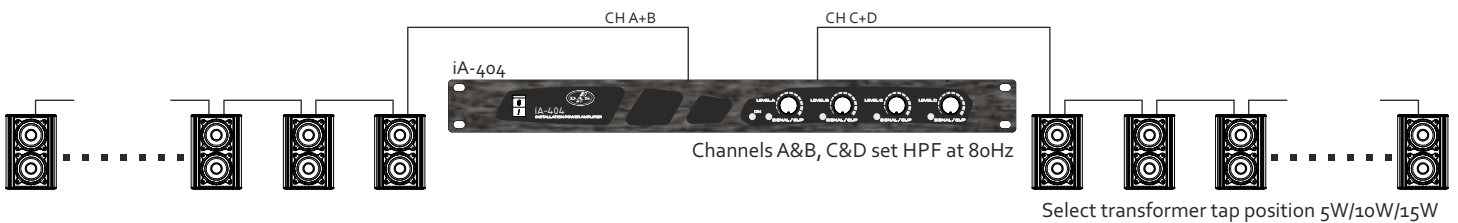

# iA-404

## Hybrid Low and High Impedance Configuration

### ARCO-4-T/ARCO-24-T + ARCO-12SUB

A&B Channels in Bridge Mode for high impedance operation  
C&D Channels in Stereo Mode for low impedance operation  
Max power available 200W at high impedance channel (20 x arco-4T at 10W)

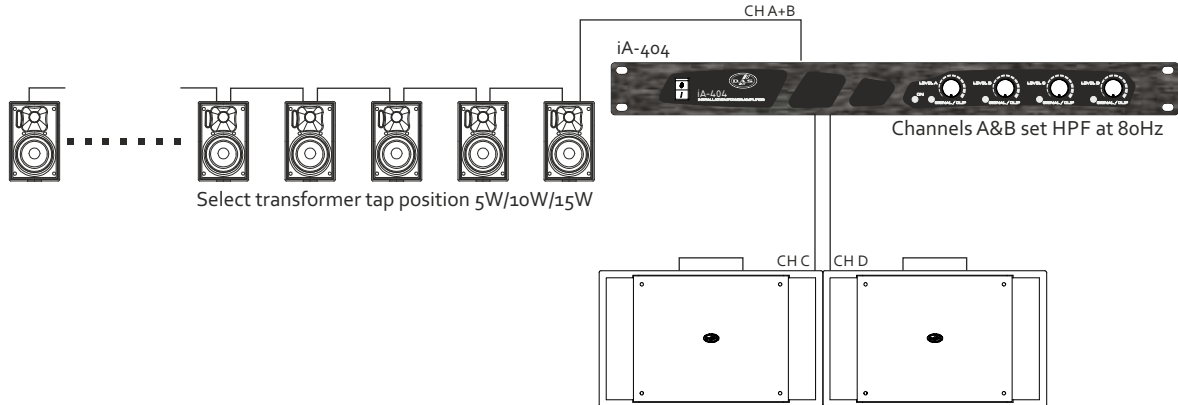

### Ceiling series

A&B Channels in Bridge Mode for high impedance operation  
C&D Channels in Stereo Mode for low impedance operation  
Max power available 200W at high impedance channel (13 x CL-6TB at 15W)

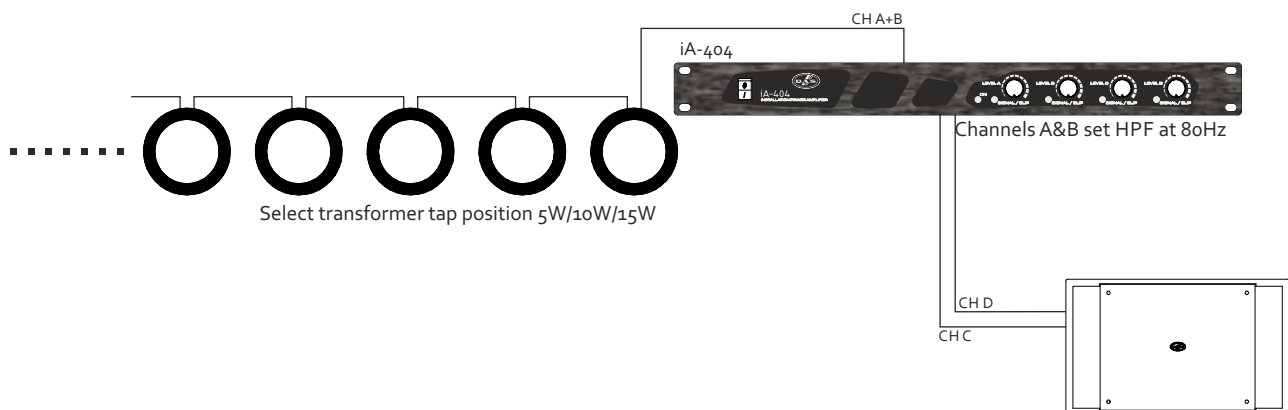

### Quantum Q-3-T + Q-23-T

A&B Channels in Bridge Mode for high impedance operation  
C&D Channels in Stereo Mode for low impedance operation  
Max power available 200W at high impedance channel (10 x Q-13i at 20W)

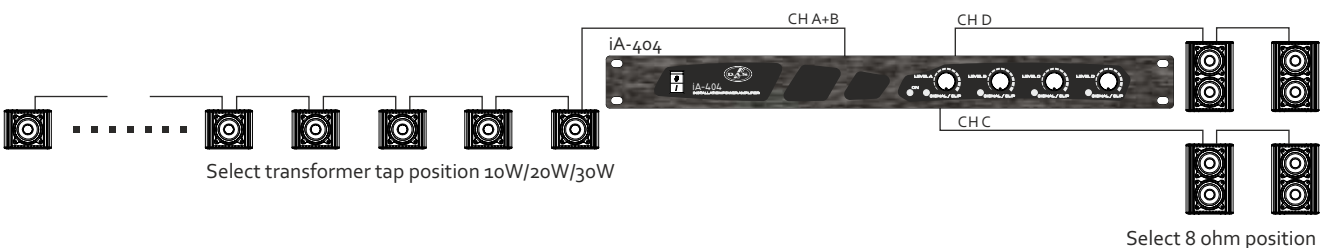

# iA-1004

## Low Impedance Configuration

### ARCO-24-T + ARCO-12SUB

All Amplifier Channels in Stereo Mode for low impedance operation

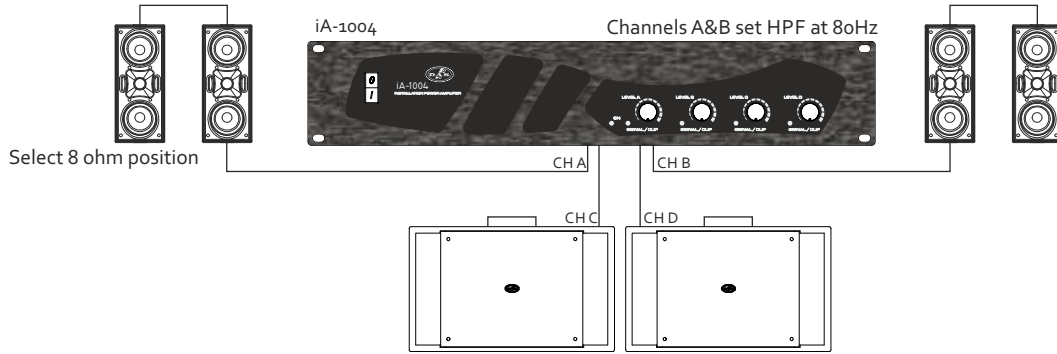

### ARTEC-306/ARTEC-308/ARTEC-310.XX + ARTEC-322S

Channels A&B in Stereo Mode

Bridge Channels C&D for subwoofer

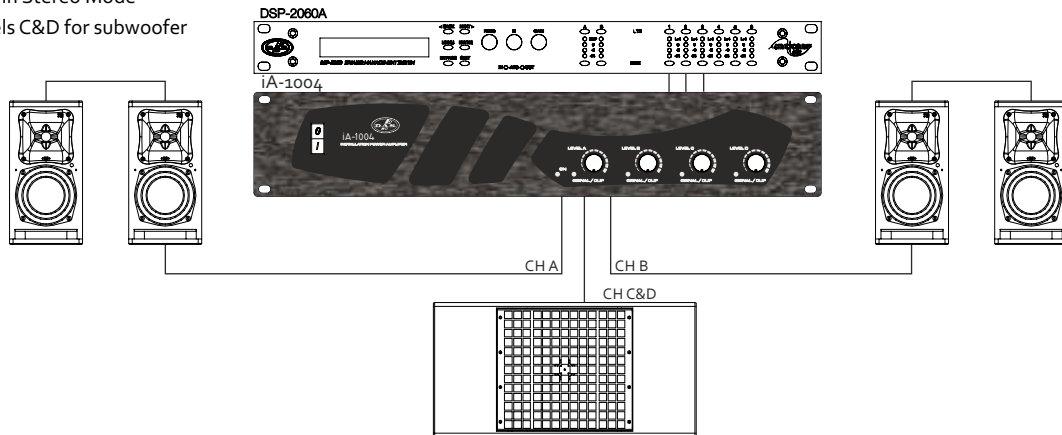

### ARTEC-506/ARTEC-508 + ARTEC-S15

Channels A&B in Stereo Mode

Bridge Channels C&D for subwoofer

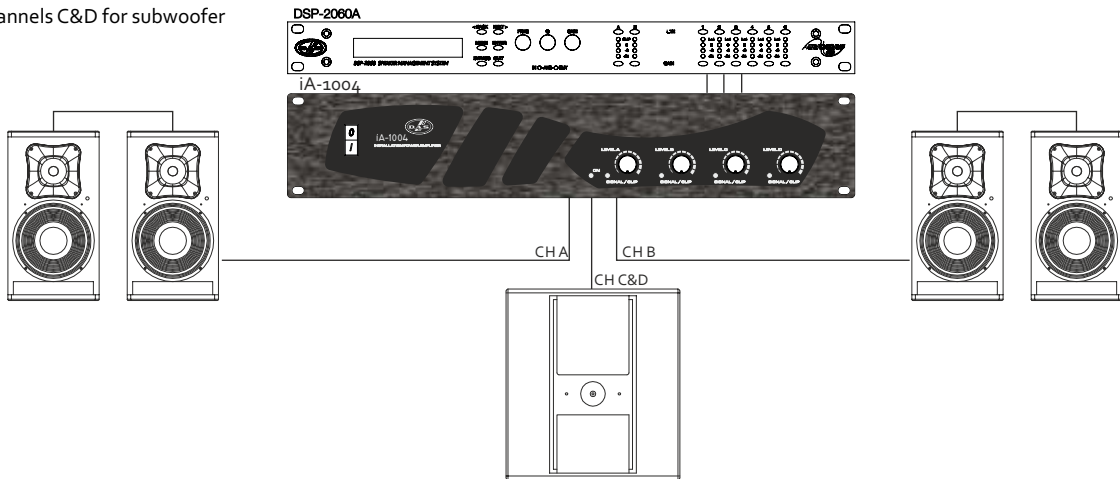

### Quantum Q-43-T + ARCO-12SUB

All Amplifier Channels in Stereo Mode for low impedance operation

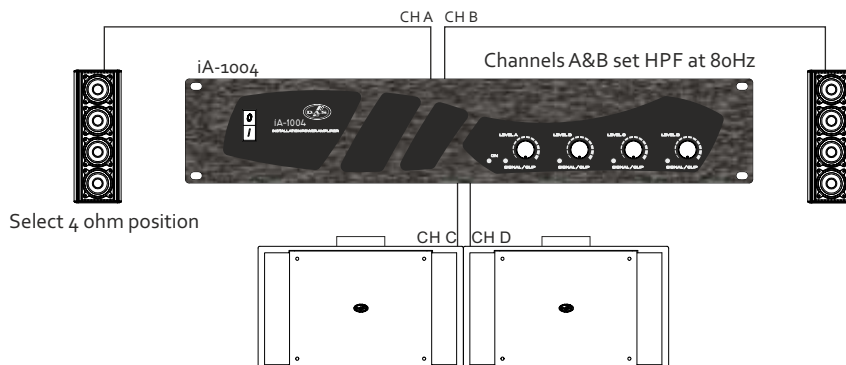



# iA-1004

## Low Impedance Configuration (cont'd)

ARTEC-306/ARTEC-308/ARTEC-310.XX

All amplifier Channels in Stereo Mode for low impedance operation

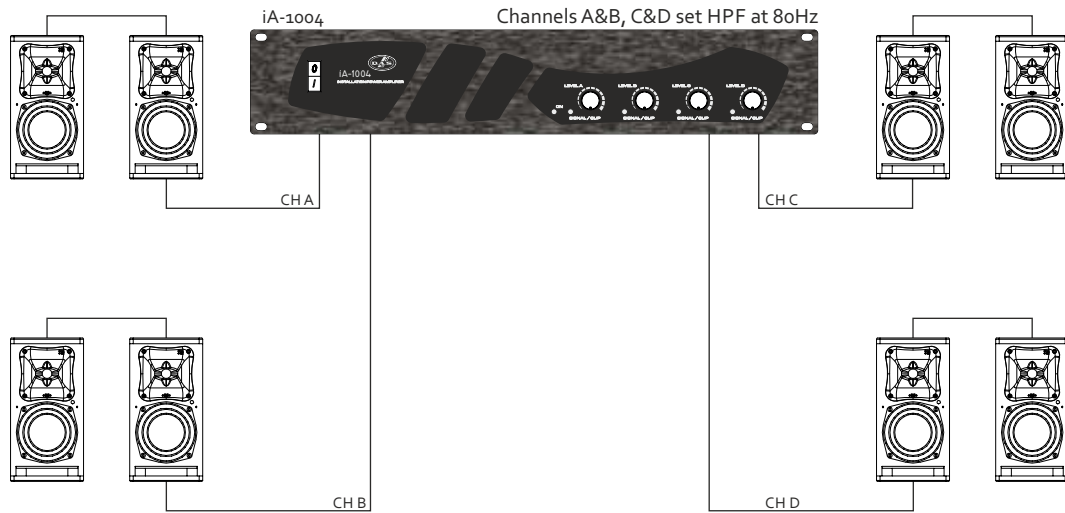

OVI-12

All Amplifier Channels in Stereo Mode for low impedance operation

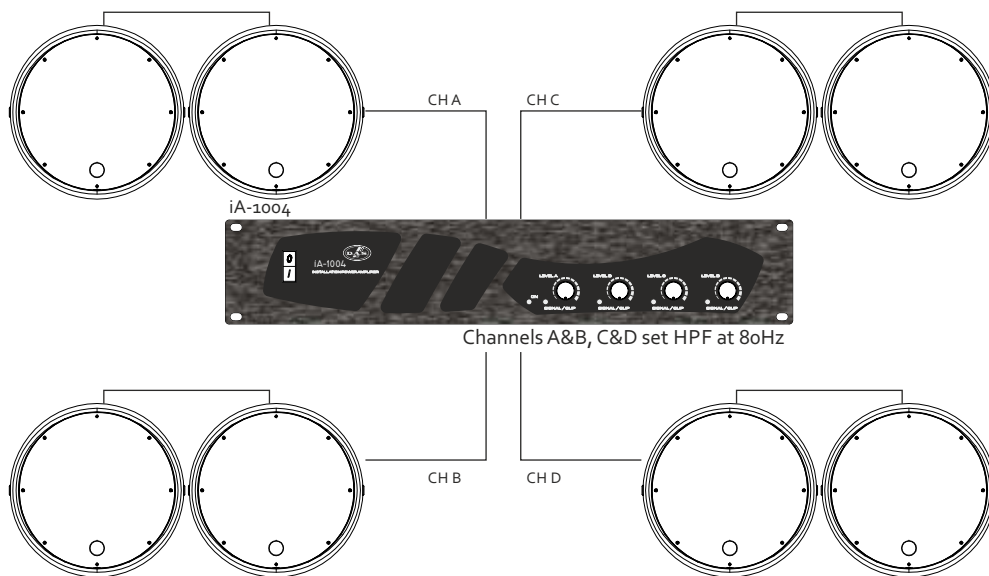

# iA-1004

## High Impedance Configuration

### ARCO-24-T

All Amplifier Channels in Bridge Mode for high impedance operation  
 Max power available 500W per channel (16 x arco-24T at 30W)

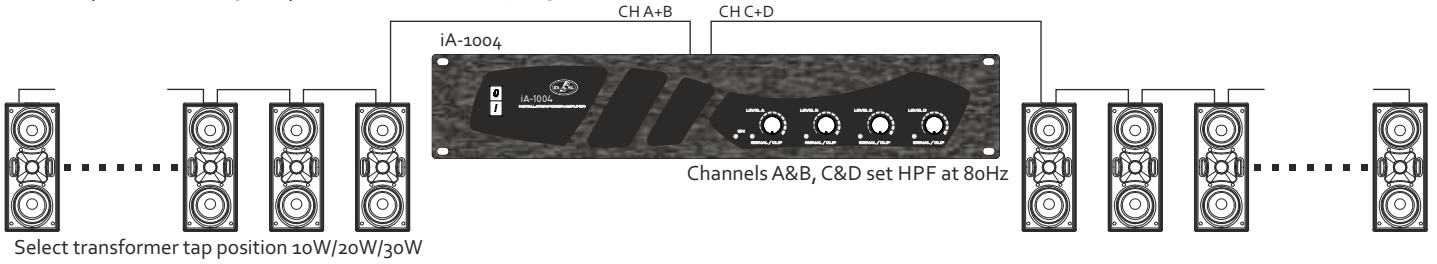

### Quantum Q-23-T

All Amplifier Channels in Bridge Mode for high impedance operation  
 Max power available 500W per channel (16 x Q-23i at 30W)

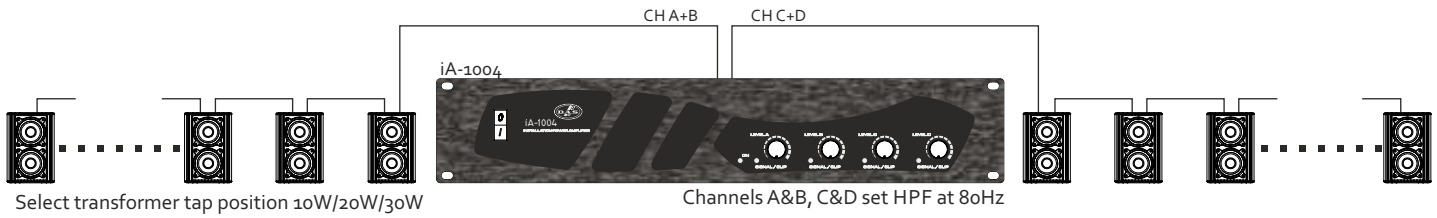

### WR-8826-T

All Amplifier Channels in Bridge Mode for high impedance operation  
 Max power available 500W per channel (10 x WR-8826T at 50W)

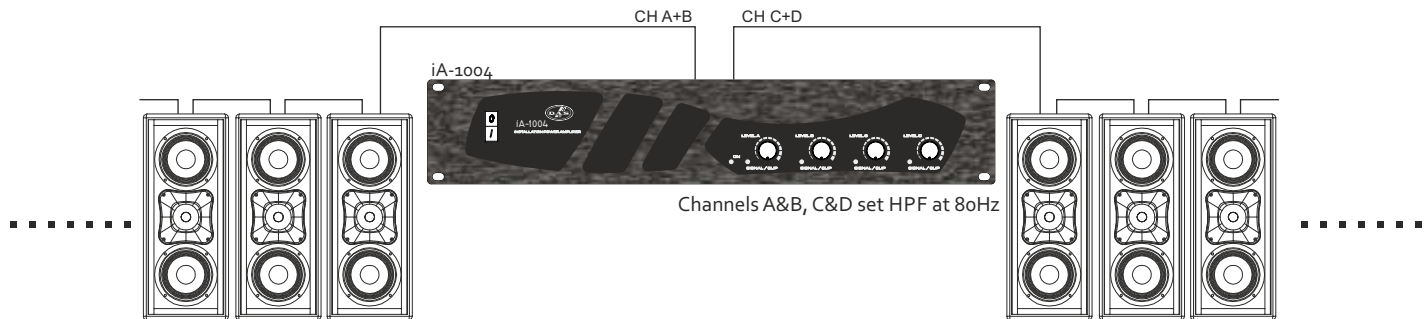

### OVI-12-T

All Amplifier Channels in Bridge Mode for high impedance operation  
 Max power available 500W per channel (3 x OVI-12T at 150W or 5 x OVI-12T at 100W)

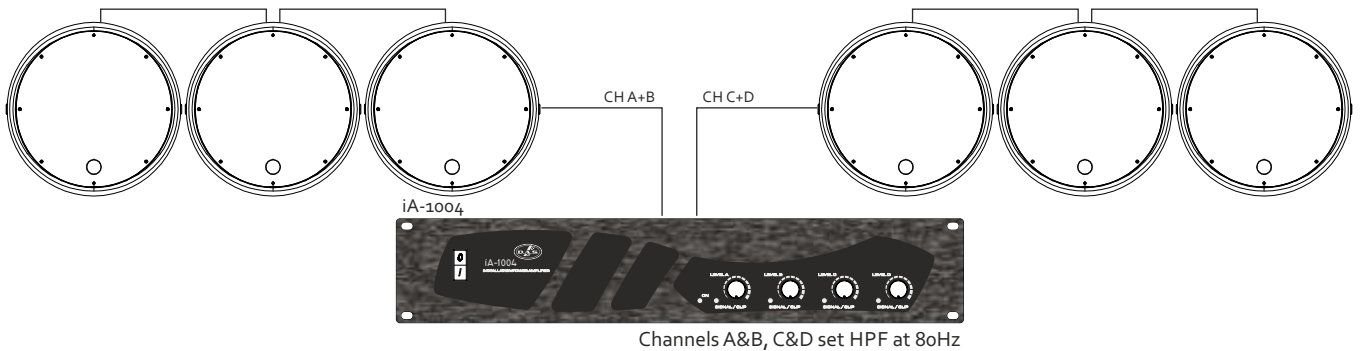

# iA-1004

## Hybrid Low and High Impedance Configuration

### Quantum Q-43-T + ARCO-12SUB

A&B Channels in Bridge Mode for high impedance operation

C&D Channels in Stereo Mode for low impedance operation

Max power available 500W at high impedance channel (10 x Q-43i at 50W)

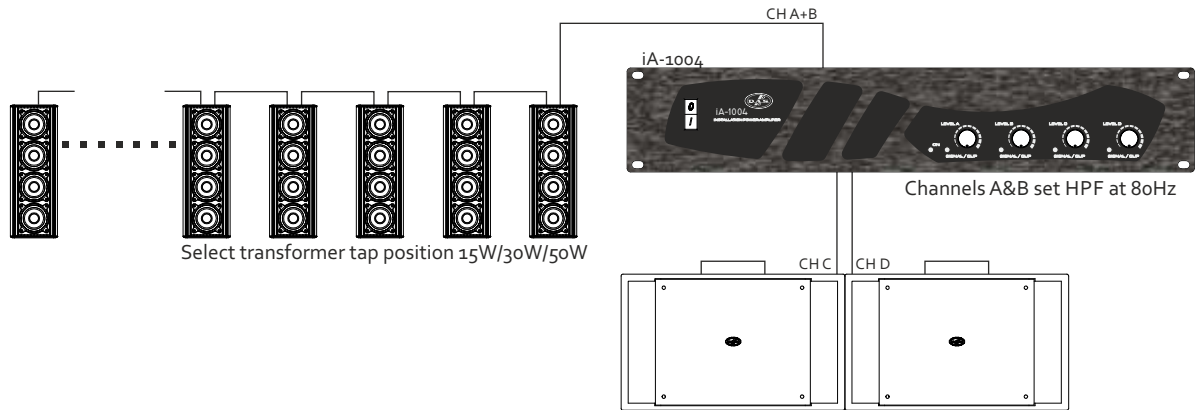

### Ceiling series + ARTEC-306/ARTEC-308

A&B Channels in Bridge Mode for high impedance operation

C&D Channels in Stereo Mode for low impedance operation

Max power available 500W at high impedance channel (16 x CL-8T at 30W)

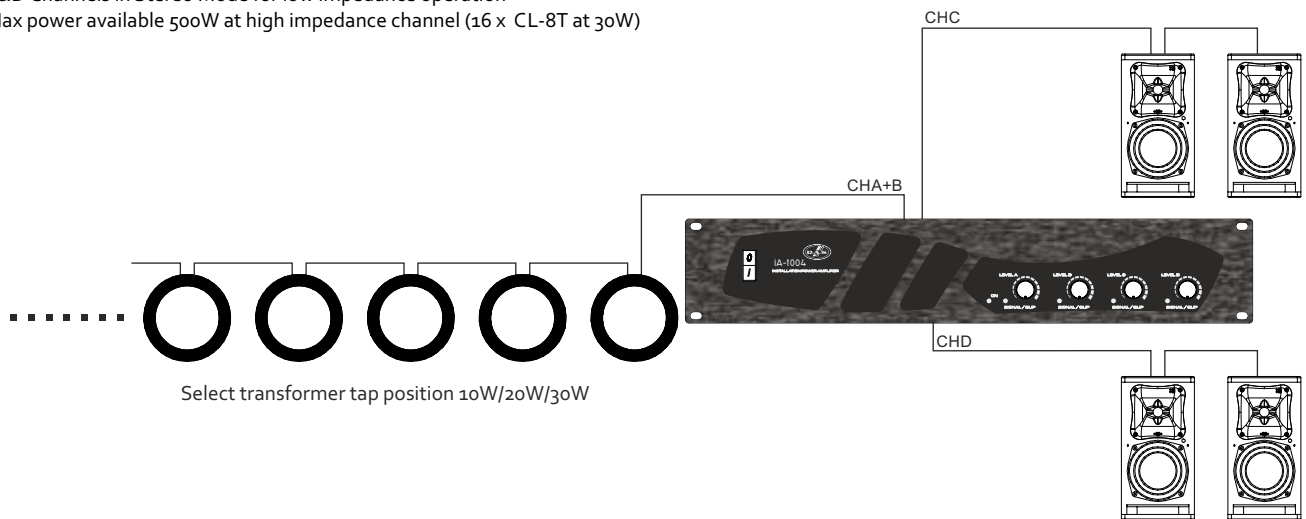

# iA-402

## Low Impedance Configuration

### ARCO-4-T

All Amplifier Channels in Stereo Mode for low impedance operation

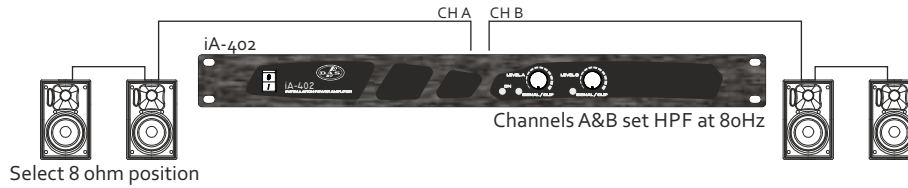

### ARCO-24-T

All Amplifier Channels in Stereo Mode for low impedance operation

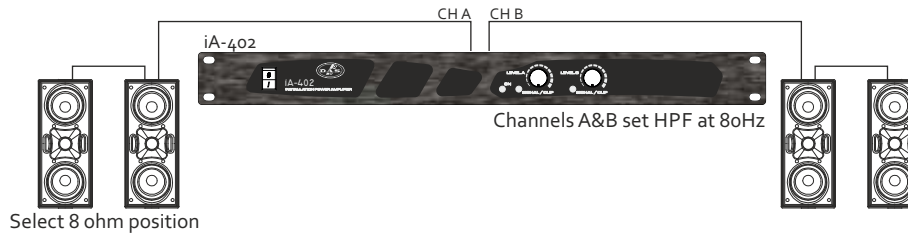

### ARCO-24-T + ARCO-12SUB

All Amplifier Channels in Stereo Mode for low impedance operation

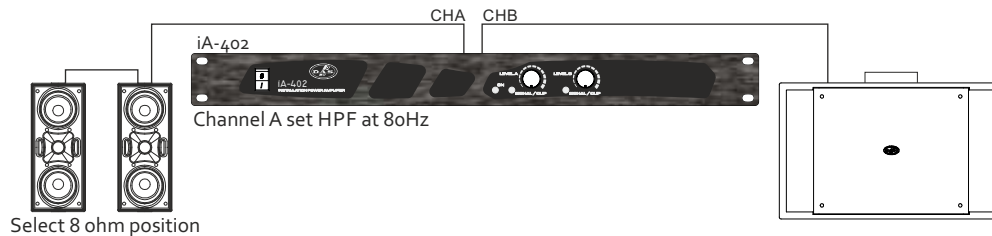

### Quantum Q-3-T/Q-23-T

All Amplifier Channels in Stereo Mode for low impedance operation

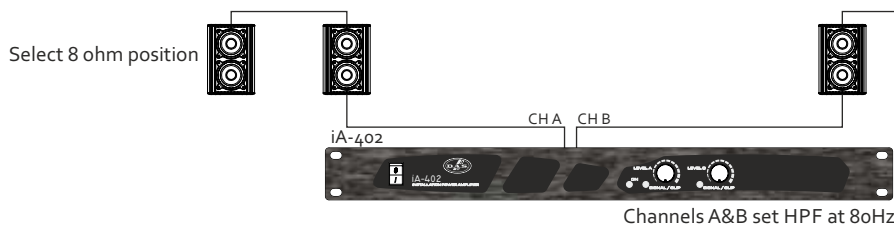

### ARTEC-306/ARTEC-308

All Amplifier Channels in Stereo Mode for low impedance operation

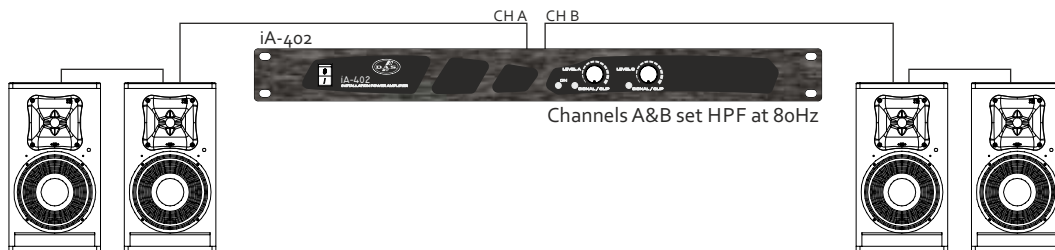

### ARTEC-306/ARTEC-308 + ARCO-12SUB

All Amplifier Channels in Stereo Mode for low impedance operation

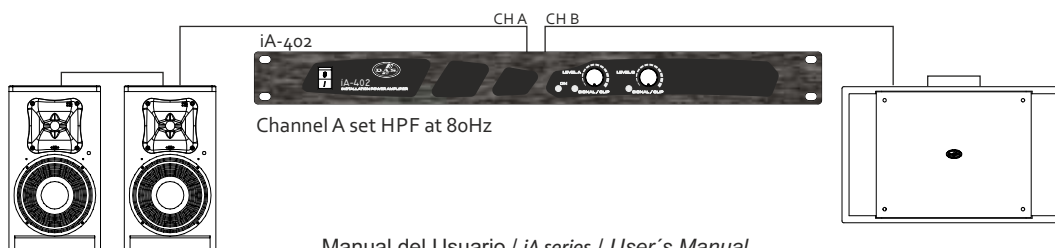

# iA-402

## High Impedance Configuration

### ARCO-4-T/ARCO-24-T

All Amplifier Channels in Bridge Mode for high impedance operation  
Max power available 400W (40 x arco-4T at 10W, 20 x arco-24T at 20W)

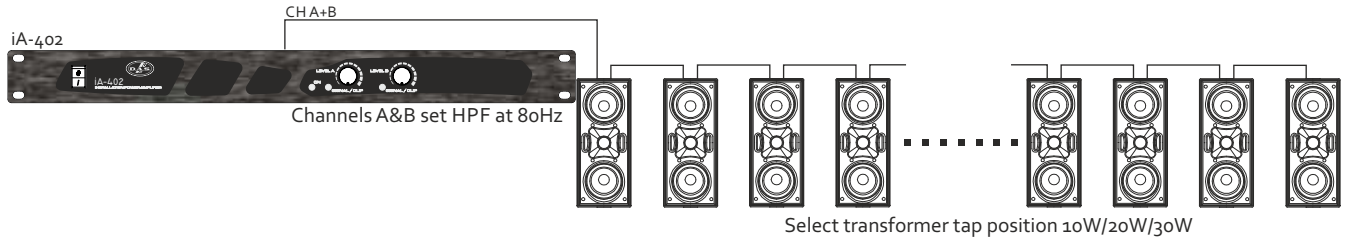

### Ceiling series

All Amplifier Channels in Bridge Mode for high impedance operation  
Max power available 400W (40 x CL-5/6/6TB/8T at 10W)

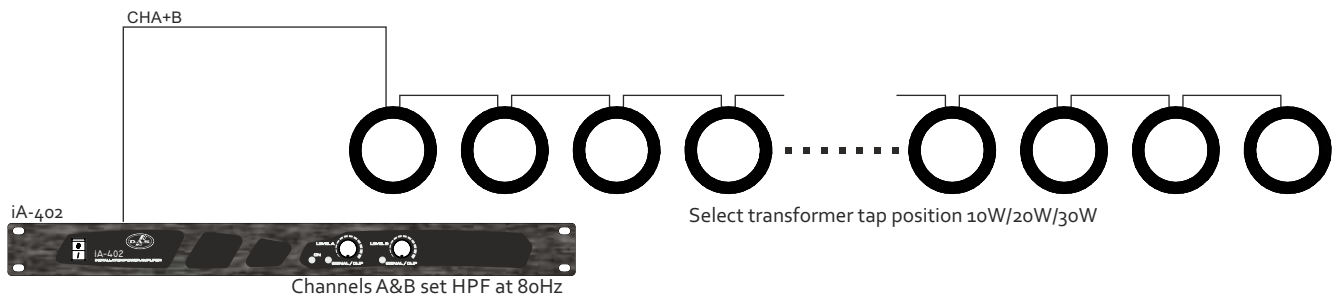

### Quantum Q-23-T

All Amplifier Channels in Bridge Mode for high impedance operation  
Max power available 400W per channel (20 x Q-23i at 20W)

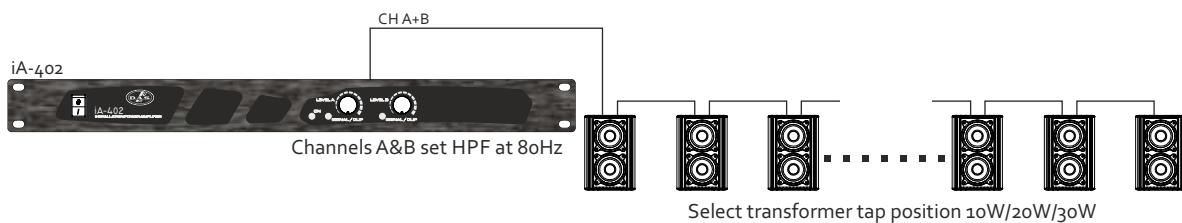

# iA-1002

## Low Impedance Configuration

### ARTEC-308/ARTEC-310.XX

All amplifier Channels in Stereo Mode for low impedance operation

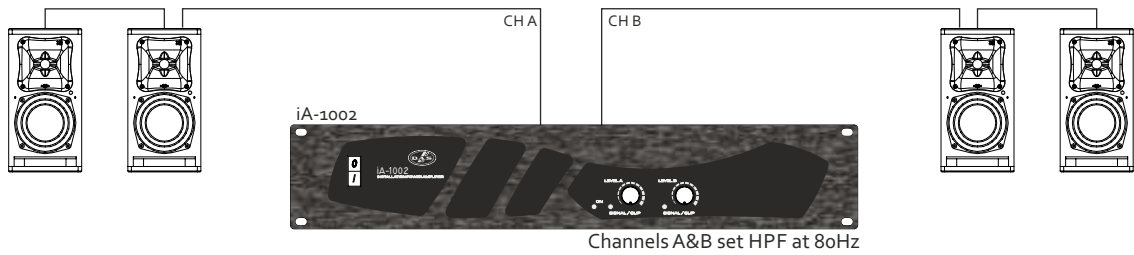

### ARTEC-506/ARTEC-508/ARTEC-510

All amplifier Channels in Stereo Mode for low impedance operation



### OVI-12

All amplifier Channels in Stereo Mode for low impedance operation



### ARTEC-308/ARTEC-310.XX + ARTEC-322S

All amplifier Channels in Stereo Mode for low impedance operation

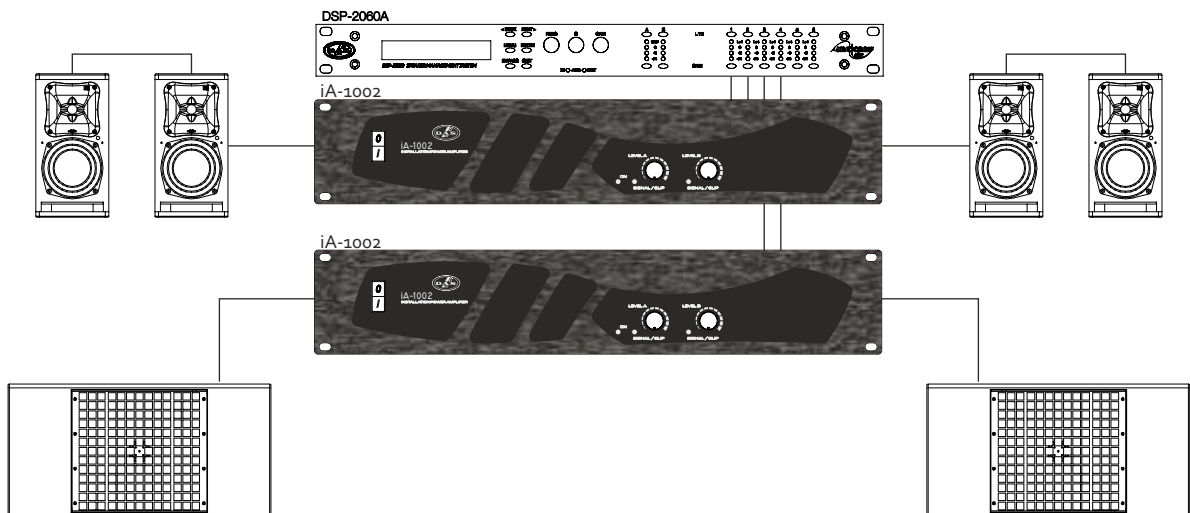

# iA-1002

## High Impedance Configuration

### ARTEC-308-T/ARTEC-310.XX-T/WR-8826-T

All Amplifier Channels in Bridge Mode for high impedance operation  
Max power available 1000W (up to 6 cabinets with 150W transformer)

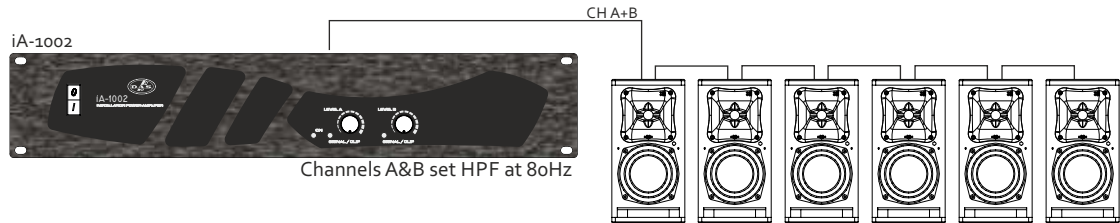

### Quantum Q-43-T

All Amplifier Channels in Bridge Mode for high impedance operation  
Max power available 1000W (up to 20 cabinets with 50W tapposition)

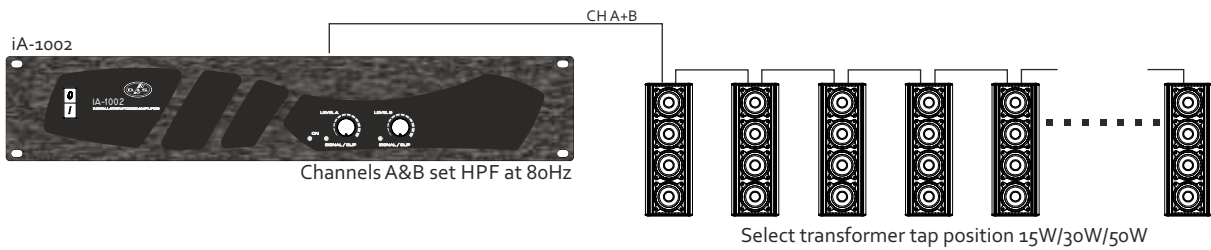

### OVI-12-T

All Amplifier Channels in Bridge Mode for high impedance operation  
Max power available 1000W (up to 6 cabinets with 150W transformer)

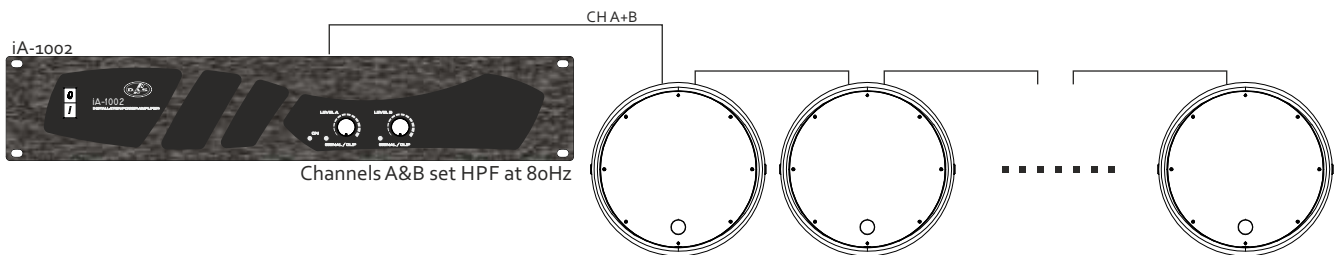

## TROUBLESHOOTING

PROBLEM	CAUSE	SOLUTION
No sound from the unit	<ol style="list-style-type: none"> <li>1 - The signal source is sending no signal.</li> <li>2 - Input gain controls are at minimum position.</li> <li>3 - Defective signal cables.</li> <li>4 - Amplifier not plugged.</li> </ol>	<ol style="list-style-type: none"> <li>1 - Check that the source is not muted and is sending signal to the unit.</li> <li>2 - Check input gain controls. Put them at maximum level.</li> <li>3 - Check that the cable from the source to the unit is connected correctly. Replace the cable if defective.</li> <li>4 - Check the connections.</li> </ol>
Full power cannot be obtained.	<ol style="list-style-type: none"> <li>1 - The signal source does not have enough output level.</li> <li>2 - Input gain controls are at very low volume.</li> </ol>	<ol style="list-style-type: none"> <li>1 - Use balanced outputs of a mixer. Rise master output volume of the source.</li> <li>2 - Set up level controls at higher positions.</li> </ol>
Sound is distorted.	<ol style="list-style-type: none"> <li>1-The mixer or signal source is distorting.</li> <li>2 - The output level from the mixer is too high.</li> <li>3 - Amplifier clip shown in the channel.</li> </ol>	<ol style="list-style-type: none"> <li>1-Turn down the mixer's output and check no channels are distorting.</li> <li>2-Turn down the mixer's output.</li> <li>3 - Turn down input gain controls or lower input signal level.</li> </ol>
Hum or buzz when a mixer is connected to the unit.	<ol style="list-style-type: none"> <li>1-The console probably has unbalanced outputs. You may be using an incorrect unbalanced to balanced cable.</li> <li>2 - The mixer and the powered speaker are not plugged into the same mains outlet.</li> <li>3 - The audio signal cable is too long or too close to an AC cable.</li> </ol>	<ol style="list-style-type: none"> <li>1-Read the appendix of this manual to make a correct unbalanced to balanced cable.</li> <li>2 - Connect the mixer and the unit to the same mains outlet.</li> <li>3 - Use a cable that is as short as possible and/or move the audio signal cable away from mains cables.</li> </ol>
Hum or buzz when using lighting controls in the same building.	<ol style="list-style-type: none"> <li>1-The audio signal cable is too long or too close to the lighting cable.</li> <li>2 - On a sound system with three phase AC, the lighting equipment and the unit are connected to the same phase.</li> </ol>	<ol style="list-style-type: none"> <li>1- Move the audio signal cable away from lighting cables. Try to find out at what point the noise is leaking into the system.</li> <li>2 - Connect the sound system to a different phase than the lights. You may need the help of an electrician.</li> </ol>
Low sound.	<ol style="list-style-type: none"> <li>1 -The audio signal cable is defective.</li> <li>2-The Level controls are not at maximum position.</li> <li>3 - Low input signal level.</li> <li>4 - Using speakers with transformer in stereo mode.</li> </ol>	<ol style="list-style-type: none"> <li>1- Check cabling and replace them.</li> <li>2 - Turn up level controls of the output channels.</li> <li>3 - Turn up the level from the source.</li> <li>4 - Change the amplifier's mode from Stereo to Bridge (100/70V).</li> </ol>
The ON led is indicating protection (Orange).	<ol style="list-style-type: none"> <li>1 - The unit has activated the thermal protection.</li> <li>2 - Short-Circuit.</li> <li>3. Defective unit.</li> </ol>	<ol style="list-style-type: none"> <li>1 - Lower the input level and make sure the amplifier is being cooled correctly. Check that the fan is working and be sure that all the air inlets/outlets are not blocked.</li> <li>2 - Check the cables, connectors and speakers connected.</li> <li>3 - Contact an authorized dealer for service.</li> </ol>



## ANNEX : Line connections: unbalanced and balanced

There are two basic ways to transport an audio signal with microphone or line level:

**Unbalanced line:** Utilising a two conductor cable, it transports the signal as the voltage between them. Electromagnetic interference can get added to the signal as undesired noise. Connectors that carry unbalanced signals have two pins, such as RCA (Phono) and ¼" (6.35mm, often referred to as jack) mono. 3 pin connector such as XLR (Cannon) may also carry unbalanced signals if one of the pins is unused.

**Balanced line:** Utilising a three conductor cable, one of them acts as a shield against electromagnetic noise and is the ground conductor. The other two have the same voltage with respect to the ground conductor but with opposite signs. The noise that cannot be rejected by the shield affects both signal conductors in the same way. At the device's input the two signals get summed with opposite sign, so that noise is cancelled out while the programme signal doubles in level. Most professional audio devices use balanced inputs and outputs. Connectors that can carry balanced signal have three pins, such as XLR (Cannon) and ¼" (6.35mm) stereo.

The graphs that follow show the recommended connection with different types of connectors to balanced processor or amplifier inputs. The connectors on the left-hand side come from a signal source, and the ones on the right hand side go to the inputs of the processor or amplifier. Note that on the unbalanced connectors on the left-hand side, two terminals are joined inside the connector. If hum occurs with balanced connections, try disconnecting the sleeve (ground) on the input connector. Note that the illustrations show what should be connected to what, but that pin locations on an actual XLR connector are different. Also, pin 2 hot is assumed on XLR connectors.

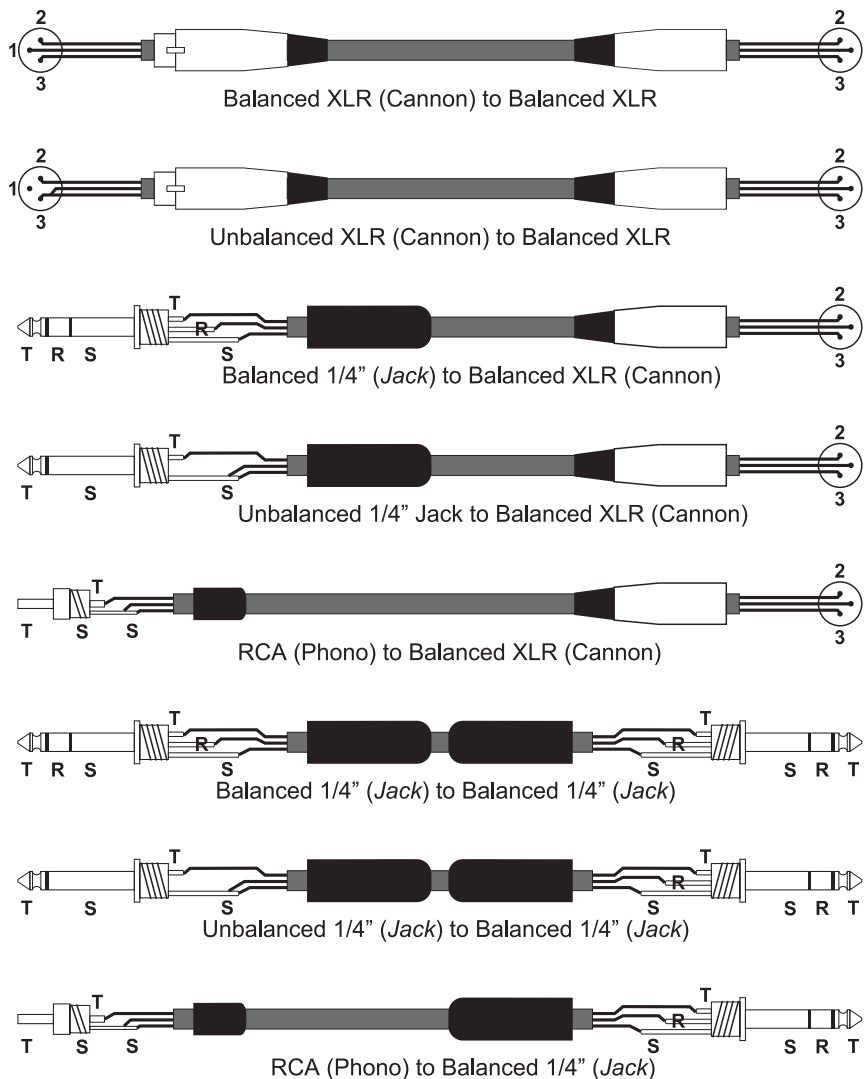



**[www.dasaudio.com](http://www.dasaudio.com)**

UM\_IA\_02\_EN

**DAS Audio Group, S.L.**  
C/. Islas Baleares, 24  
46988 Fuente del Jarro  
Valencia, SPAIN  
Tel. +34 96 134 0860

**DAS Audio of America, INC.**  
6900 NW 52th Street  
Miami, FL. 33166 - U.S.A.  
TOLL FREE: 1 888 DAS 4 USA

**DAS Audio Asia PTE. LTD.**  
3 Temasek Avenue, Centennial  
Tower #34-36  
Singapore 039190  
Tel. +65 6549 7760

**DAS do Brasil LTDA.**  
Rua Dos Andradas, 382 SL  
Santa Efigênia, São Paulo  
Brasil. CEP: 01208-000  
Tel. +551133330764